

TV SPEAKER

Please read and keep all safety, security, and use instructions.

CE Bose Corporation hereby declares that this product is in compliance with the essential requirements and other relevant provisions of Directive 2014/53/EU and all other applicable EU directive requirements. The complete declaration of conformity can be found at: www.Bose.com/compliance

**UK
CA** This product conforms to all applicable Electromagnetic Compatibility Regulations 2016 and all other applicable UK regulations. The complete declaration of conformity can be found at: www.Bose.com/compliance

Bose Corporation hereby declares that this product is in compliance with the essential requirements per Radio Equipment Regulations 2017 and all other applicable UK regulations. The complete declaration of conformity can be found at: www.Bose.com/compliance

Important Safety Instructions

1. Read these instructions.
2. Keep these instructions.
3. Heed all warnings.
4. Follow all instructions.
5. Do not use this apparatus near water.
6. Clean only with a dry cloth.
7. Do not block any ventilation openings. Install in accordance with the manufacturer's instructions.
8. Do not install near any heat sources such as radiators, heat registers, stoves, or other apparatus (including amplifiers) that produce heat.
9. Only use attachments/accessories specified by the manufacturer.
10.  Use only with the cart, stand, tripod, bracket, or table specified by the manufacturer, or sold with the apparatus. When a cart is used, use caution when moving the cart/apparatus combination to avoid injury from tip-over.
11. Unplug this apparatus during lightning storms or when unused for long periods of time.
12. Refer all servicing to qualified personnel. Servicing is required when the apparatus has been damaged in any way, such as power-supply cord or plug is damaged, liquid has been spilled or objects have fallen into the apparatus, the apparatus has been exposed to rain or moisture, does not operate normally, or has been dropped.

WARNINGS/CAUTIONS



This symbol on the product means there is uninsulated, dangerous voltage within the product enclosure that may present a risk of electrical shock.



This symbol on the product means there are important operating and maintenance instructions in this guide.



Do not ingest battery, chemical burn hazard. The remote control supplied with this product contains a coin/button cell battery. If the coin/button cell battery is swallowed, it can cause severe internal burns in just 2 hours and can lead to death. Keep new and used batteries away from children. If the battery compartment does not close securely, stop using the remote control and keep it away from children. If you think batteries might have been swallowed or placed inside any part of the body, seek immediate medical attention. To avoid risk of explosion, fire or chemical burn, use caution in replacing the battery and replace only with an agency approved (e.g., UL) CR2032 or DL2032 3-volt lithium battery. Properly and promptly dispose of used batteries. Do not recharge, disassemble, heat above 212° F (100° C) or incinerate.



Contains small parts which may be a choking hazard. Not suitable for children under age 3.



This product contains magnetic material. Consult your physician on whether this might affect your implantable medical device.

- To reduce the risk of fire or electrical shock, do NOT expose this product to rain, liquids or moisture.
- Do NOT expose this product to dripping or splashing, and do not place objects filled with liquids, such as vases, on or near the product.
- Keep the product away from fire and heat sources. Do NOT place naked flame sources, such as lighted candles, on or near the product.
- Do NOT make unauthorized alterations to this product.
- Do NOT use a power inverter with this product.
- The speaker wire and interconnect cables included with this system are not approved for in-wall installation. Please check your local building codes for the correct type of wire and cable required for in-wall installation.
- Where the mains plug or an appliance coupler is used as the disconnect device, the disconnect device shall remain readily operable.



仅适用于 2000m 以下地区安全使用
Use at altitude less than 2000 meters only.

- The battery provided with this product may present a risk of fire, explosion or chemical burn if mishandled, incorrectly replaced or replaced with an incorrect type.
- Only use the following hardware to mount this product: Bose Soundbar Wall Bracket.
- Do not mount on surfaces that are not sturdy, or that have hazards concealed behind them, such as electrical wiring or plumbing. If you are not sure about installing the bracket, contact a qualified professional installer. Ensure the bracket is installed according to local building codes.
- Due to ventilation requirements, Bose does not recommend placing the product in a confined space such as in a wall cavity or in an enclosed cabinet.
- The product label is located on the back of the speaker.

NOTE: This equipment has been tested and found to comply with the limits for a Class B digital device, pursuant to Part 15 of the FCC Rules. These limits are designed to provide reasonable protection against harmful interference in a residential installation. This equipment generates, uses, and can radiate radio frequency energy and, if not installed and used in accordance with the instructions, may cause harmful interference to radio communications. However, there is no guarantee that interference will not occur in a particular installation. If this equipment does cause harmful interference to radio or television reception, which can be determined by turning the equipment off and on, the user is encouraged to try to correct the interference by one or more of the following measures:

- Reorient or relocate the receiving antenna.
- Increase the separation between the equipment and receiver.
- Connect the equipment into an outlet on a circuit different from that to which the receiver is connected.
- Consult the dealer or an experienced radio/TV technician for help.

Changes or modifications not expressly approved by Bose Corporation could void the user's authority to operate this equipment.

This device complies with part 15 of the FCC Rules and with ISED Canada license-exempt RSS standard(s). Operation is subject to the following two conditions: (1) This device may not cause harmful interference, and (2) this device must accept any interference received, including interference that may cause undesired operation.

This device complies with FCC and ISED Canada radiation exposure limits set forth for general population. This equipment should be installed and operated with a minimum distance of 20 cm between radiator and your body. This transmitter must not be co-located or operating in conjunction with any other antenna or transmitter.

CAN ICES-3(B)/NMB-3(B)

For Europe:

Frequency band of operation 2400 to 2483.5 MHz.

Maximum transmit power less than 20 dBm EIRP.

Maximum transmit power is below regulatory limits such that SAR testing is not necessary and exempt per applicable regulations.



This symbol means the product must not be discarded as household waste, and should be delivered to an appropriate collection facility for recycling. Proper disposal and recycling helps protect natural resources, human health and the environment. For more information on disposal and recycling of this product, contact your local municipality, disposal service, or the shop where you bought this product.

Management Regulation for Low-power Radio-frequency Devices

Article XII

According to "Management Regulation for Low-power Radio-frequency Devices" without permission granted by the NCC, any company, enterprise, or user is not allowed to change frequency, enhance transmitting power or alter original characteristic as well as performance to an approved low power radio-frequency devices.

Article XIV

The low power radio-frequency devices shall not influence aircraft security and interfere legal communications; If found, the user shall cease operating immediately until no interference is achieved. The said legal communications means radio communications operated in compliance with the Telecommunications Act.

The low power radio-frequency devices must be susceptible with the interference from legal communications or ISM radio wave radiated devices.



Please dispose of used batteries properly, following local regulations. Do not incinerate.

廢電池回收

Product Power State Table

The product, in accordance with the Ecodesign Requirements for Energy Related Products Directive 2009/125/EC and the Ecodesign for Energy-Related Products and Energy Information (Amendment) (EU Exit) Regulations 2020, is in compliance with the following norm(s) or document(s): Regulation (EC) No. 1275/2008, as amended by Regulation (EU) No. 801/2013.

Required Power State Information	Power Modes	
	Standby	Networked Standby
Power consumption in specified power mode, at 230V/50Hz input	< 0.5 W	Bluetooth® < 2.0 W
Time after which equipment is automatically switched into mode	< 2.5 hours	≤ 20 minutes
Power consumption in networked standby if all wired network ports are connected and all wireless network ports are activated, at 230V/50Hz input	N/A	< 2.0 W
Network port deactivation/activation procedures. Deactivating all networks will enable standby mode.	Bluetooth: Deactivate by clearing the pairing list by pressing and holding the <i>Bluetooth</i> button for 10 seconds. Activate by pairing with a <i>Bluetooth</i> source.	

China Restriction of Hazardous Substances Table

Names and Contents of Toxic or Hazardous Substances or Elements						
Part Name	Toxic or Hazardous Substances and Elements					
	Lead (Pb)	Mercury (Hg)	Cadmium (Cd)	Hexavalent (CR(VI))	Polybrominated Biphenyl (PBB)	Polybrominated diphenylether (PBDE)
PCBs	X	0	0	0	0	0
Metal Parts	X	0	0	0	0	0
Plastic Parts	0	0	0	0	0	0
Speakers	X	0	0	0	0	0
Cables	X	0	0	0	0	0
This table is prepared in accordance with the provisions of SJ/T 11364.						
0: Indicates that this toxic or hazardous substance contained in all of the homogeneous materials for this part is below the limit requirement of GB/T 26572.						
X: Indicates that this toxic or hazardous substance contained in at least one of the homogeneous materials used for this part is above the limit requirement of GB/T 26572.						

Taiwan Restriction of Hazardous Substances Table

Equipment name: Powered Speaker, Type designation: 431974						
Restricted substances and its chemical symbols						
Unit	Lead (Pb)	Mercury (Hg)	Cadmium (Cd)	Hexavalent chromium (Cr+6)	Polybrominated biphenyls (PBB)	Polybrominated diphenyl ethers (PBDE)
PCBs	-	o	o	o	o	o
Metal Parts	-	o	o	o	o	o
Plastic Parts	o	o	o	o	o	o
Speakers	-	o	o	o	o	o
Cables	-	o	o	o	o	o
Note 1: "o" indicates that the percentage content of the restricted substance does not exceed the percentage of reference value of presence.						
Note 2: The "-" indicates that the restricted substance corresponds to the exemption.						

Date of Manufacture: The eighth digit in the serial number indicates the year of manufacture; “1” is 2011 or 2021.

China Importer: Bose Electronics (Shanghai) Company Limited, Level 6, Tower D, No. 2337 Gudai Rd. Minhang District, Shanghai 201100

EU Importer: Bose Products B.V., Gorslaan 60, 1441 RG Purmerend, The Netherlands

Taiwan Importer: Bose Taiwan Branch, 9F-A1, No. 10, Section 3, Minsheng East Road, Taipei City 104, Taiwan
Phone Number: +886-2-2514 7676

Mexico Importer: Bose de México, S. de R.L. de C.V., Paseo de las Palmas 405-204, Lomas de Chapultepec, 11000 México, D.F. Phone Number: +5255 (5202) 3545

UK Importer: Bose Limited, Bose House, Quayside Chatham Maritime, Chatham, Kent, ME4 4QZ, United Kingdom

Input Rating: 100-240 V \sim 50/60 HZ, 36W

Model Number: 431974

The CMIIT ID is located on the product label on the back of the speaker.

California: Contains lithium ion battery with Perchlorate Material - special handling may apply.
See www.dtsc.ca.gov/hazardouswaste/perchlorate

Please complete and retain for your records

The serial and model numbers are located on the back of the speaker.

Serial number: _____

Model number: _____

Please keep your receipt with your owner's guide. Now is a good time to register your Bose product.
You can easily do this by going to global.Bose.com/register

Security Information



This product contains software. Bose may provide updates from time to time, including those to address security issues that may impact product functionality. You are responsible for applying updates for the products you own, and may access them by contacting Bose customer service, visit: [worldwide.bose.com/contact](https://www.worldwide.bose.com/contact)

The *Bluetooth*® word mark and logos are registered trademarks owned by Bluetooth SIG, Inc. and any use of such marks by Bose Corporation is under license.

 **Dolby Audio** Dolby, Dolby Audio, and the double-D symbol are trademarks of Dolby Laboratories Licensing Corporation. Manufactured under license from Dolby Laboratories. Confidential unpublished works. Copyright 1992–2019 Dolby Laboratories. All rights reserved.

 **HDMI**™ The terms HDMI, HDMI High-Definition Multimedia Interface, HDMI Trade dress and the HDMI Logos are trademarks or registered trademarks of HDMI Licensing Administrator, Inc.



Roku TV, Roku TV Ready, and the Roku TV Ready logo are trademarks of Roku, Inc.

Bose, Bose Bass Module, Bose Home Speaker, Bose Music, Bose Portable Home Speaker, Bose Soundbar, Bose Soundbar Wall Bracket, Bose TV Speaker, and SimpleSync are trademarks of Bose Corporation.

Bose Corporation Headquarters: 1-877-230-5639

©2022 Bose Corporation. No part of this work may be reproduced, modified, distributed, or otherwise used without prior written permission.

FreeRTOS Kernel V10.0.1

Copyright (C) 2017 Amazon.com, Inc. or its affiliates. All Rights Reserved.

Permission is hereby granted, free of charge, to any person obtaining a copy of this software and associated documentation files (the "Software"), to deal in the Software without restriction, including without limitation the rights to use, copy, modify, merge, publish, distribute, sublicense, and/or sell copies of the Software, and to permit persons to whom the Software is furnished to do so, subject to the following conditions:

The above copyright notice and this permission notice shall be included in all copies or substantial portions of the Software.

THE SOFTWARE IS PROVIDED "AS IS", WITHOUT WARRANTY OF ANY KIND, EXPRESS OR IMPLIED, INCLUDING BUT NOT LIMITED TO THE WARRANTIES OF MERCHANTABILITY, FITNESS FOR A PARTICULAR PURPOSE AND NONINFRINGEMENT. IN NO EVENT SHALL THE AUTHORS OR COPYRIGHT HOLDERS BE LIABLE FOR ANY CLAIM, DAMAGES OR OTHER LIABILITY, WHETHER IN AN ACTION OF CONTRACT, TORT OR OTHERWISE, ARISING FROM, OUT OF OR IN CONNECTION WITH THE SOFTWARE OR THE USE OR OTHER DEALINGS IN THE SOFTWARE.

<http://www.FreeRTOS.org>

<http://aws.amazon.com/freertos>

Heatshrink-0.4.1

Copyright (c) 2011-2015 Scott Vokes <vokes.s@gmail.com>

Permission to use, copy, modify, and/or distribute this software for any purpose with or without fee is hereby granted, provided that the above copyright notice and this permission notice appear in all copies.

THE SOFTWARE IS PROVIDED "AS IS" AND THE AUTHOR DISCLAIMS ALL WARRANTIES WITH REGARD TO THIS SOFTWARE INCLUDING ALL IMPLIED WARRANTIES OF MERCHANTABILITY AND FITNESS. IN NO EVENT SHALL THE AUTHOR BE LIABLE FOR ANY SPECIAL, DIRECT, INDIRECT, OR CONSEQUENTIAL DAMAGES OR ANY DAMAGES WHATSOEVER RESULTING FROM LOSS OF USE, DATA OR PROFITS, WHETHER IN AN ACTION OF CONTRACT, NEGLIGENCE OR OTHER TORTIOUS ACTION, ARISING OUT OF OR IN CONNECTION WITH THE USE OR PERFORMANCE OF THIS SOFTWARE.

WHAT'S IN THE BOX

Contents 12

SPEAKER PLACEMENT

Recommendations..... 13

Wall mount the speaker 14

Adjust audio for wall mounting..... 14

SET UP THE SPEAKER

Cable options 15

Connect the speaker to your TV..... 16

Option 1: Optical..... 16

Option 2: HDMI™ ARC (not provided)..... 17

Connect the speaker to power 18

Turn off your TV speakers 19

Check for sound 19

SPEAKER CONTROLS

Remote functions..... 20

Power..... 21

Auto-wake 22

Volume 23

Sources 24

Dialogue mode..... 25

Adjust the bass 26

Reset the bass 27

Program a third-party remote 28

Put the speaker into program mode..... 28

Program the TV remote 29

BLUETOOTH® CONNECTIONS

Connect a mobile device 30

Disconnect a mobile device..... 31

Reconnect a mobile device..... 31

Connect an additional mobile device 32

Clear the speaker device list..... 32

SPEAKER STATUS

Bluetooth status 33

Media playback and volume status 34

Error status..... 35

ADVANCED FEATURES

Connect accessories (optional)..... 36

ALTERNATE SETUP

Roku TV Ready™ 37

No optical or HDMI port on your TV 38

 TV only has an analog port..... 38

 TV only has a headphone port..... 39

CONNECT BOSE PRODUCTS

Connect a Bose Home Speaker or Soundbar 40

 Compatible products 40

 Connect using the Bose Music app 40

Reconnect to a Bose Home Speaker or Soundbar 41

CARE AND MAINTENANCE

Replace the remote battery..... 42
Clean the speaker 43
Replacement parts and accessories..... 43
Limited warranty 43

TROUBLESHOOTING

Try these solutions first 44
Other solutions 44

CONTENTS

Confirm that the following parts are included:



Bose TV Speaker



Bose TV Speaker remote
(battery provided)

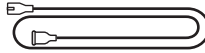

Power cord*

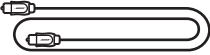

Optical cable

* May ship with multiple power cords. Use the power cord for your region.

NOTE: If any part of the product is damaged, don't use it. Contact your authorized Bose dealer or Bose customer service.

Visit: worldwide.Bose.com/Support/TVS

RECOMMENDATIONS

- Place the speaker outside of and away from metal cabinets, other audio/video components, and direct heat sources.
- Place the speaker directly below (preferred) or above your TV with the grille facing into the room.
- Place the speaker on its rubber feet on a stable and level surface. For proper support, both feet must be resting on the surface. Vibration can cause the speaker to move, particularly on smooth surfaces like marble, glass, or highly polished wood.
- If placing the speaker on a shelf or TV stand, position the front of the speaker as close as possible to the front edge of the shelf or stand for optimal sound quality.
- Keep the back side of the speaker at least 0.4 in (1 cm) from any other surface. Blocking the ports on this side affects sound quality.
- Make sure there is an AC (mains) outlet nearby.
- To avoid wireless interference, keep other wireless equipment 1 – 3 ft (0.3 – 0.9 m) away from the speaker.
- For best sound quality, don't place the speaker in an enclosed cabinet or diagonally in a corner.
- Don't place any objects on top of the speaker.

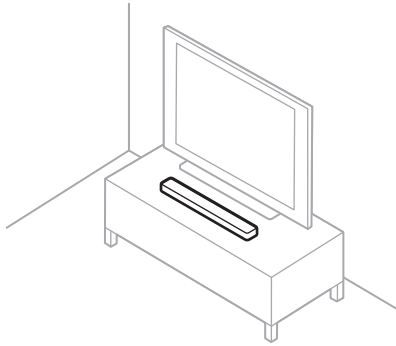

CAUTION: Do NOT place the speaker on its front, back, or top when in use.

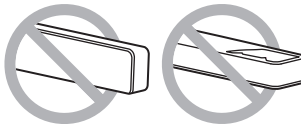

WALL MOUNT THE SPEAKER

You can mount the speaker on a wall. To purchase the Bose Soundbar Wall Bracket, contact your authorized Bose dealer.

Visit: worldwide.Bose.com/Support/TVS

CAUTION: Do NOT use any other hardware to mount the speaker.

Adjust audio for wall mounting

On the remote, press and hold the Dialogue mode button  for 5 seconds until the TV light on the speaker blinks amber.

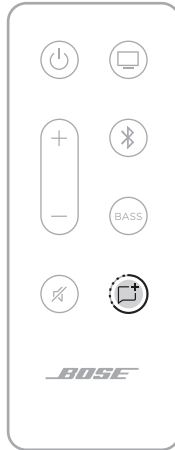

NOTE: If the speaker is taken off the wall repeat to adjust the audio again.

CABLE OPTIONS

Connect your TV to the speaker using one of the two cable options.

- **Option 1:** Optical
- **Option 2:** HDMI ARC (not provided)

NOTES:

- Using your TV's HDMI ARC or Audio Return Channel port allows you to use your TV remote to control the power, volume, and mute functions of the speaker.
 - If your TV does not have either an Optical or HDMI port see "Alternate Setup" on page 37.
 - If you switch between the cable options, power off the speaker before connecting the new cable (see page 21).
 - The speaker is Roku TV Ready™. For more information about setting up the speaker with your Roku TV™, see page 37.
1. On the back of your TV, locate the **Audio OUT** (optical) or **HDMI ARC IN** port panels.

NOTE: Your TV's port panel may not appear as shown. Look for the shape of the port.

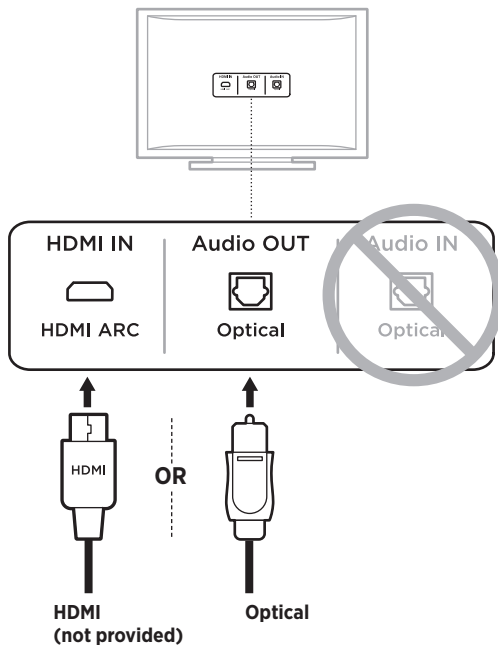

2. Choose an audio cable.

CONNECT THE SPEAKER TO YOUR TV

Option 1: Optical

1. Remove the protective cap from both ends of the optical cable.



CAUTION: Make sure you have removed the protective cap from both ends of the optical cable. Inserting the plug with the cap on or in the wrong orientation can damage the plug and/or the port.

2. Align one end of the plug with your TV's **Optical OUT** port and insert the plug carefully.
3. Hold the plug at the end of the optical cable with the Bose logo facing down.
4. Align the plug with the speaker's **OPTICAL IN** port and insert the plug carefully.

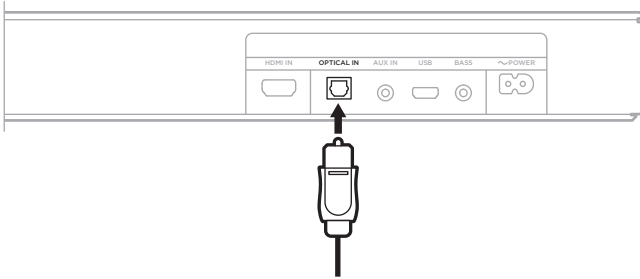

NOTE: The port has a hinged door that swings inward when inserting the plug.

5. Firmly push the plug into the port until you hear or feel a click.



Option 2: HDMI ARC (not provided)

1. Insert one end of the HDMI cable into your TV's **HDMI ARC** port.

NOTE: If you don't connect to your TV's HDMI ARC or Audio Return Channel port, you won't hear audio from the speaker. If your TV doesn't have an HDMI ARC port, connect your speaker using the provided optical cable (see page 16).

2. Insert the other end of the cable into the **HDMI IN** port on the speaker.

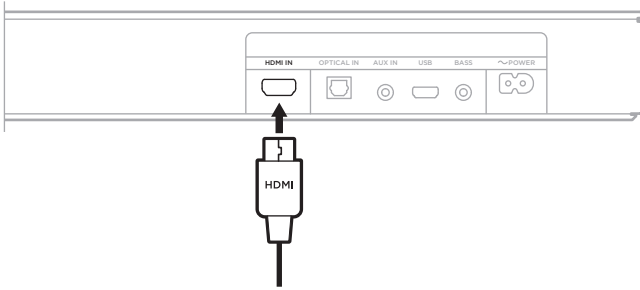

CONNECT THE SPEAKER TO POWER

1. Connect the power cord to the  **POWER** port on the back of the speaker.
2. Plug the other end of the power cord into an AC (mains) power outlet.

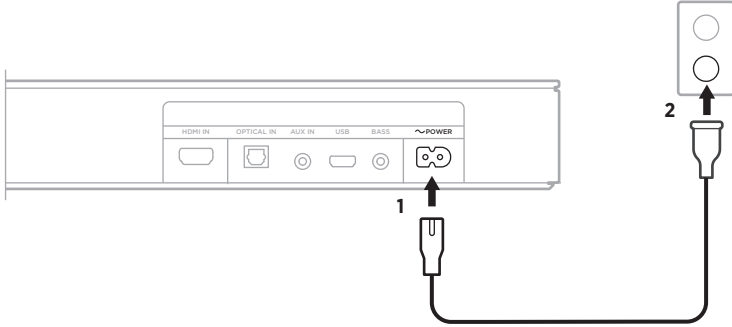

The speaker powers on, and you hear a tone.

TURN OFF YOUR TV SPEAKERS

To avoid hearing distorted sound, turn off your TV speakers.

For more information, refer to your TV owner's guide.

TIP: The audio settings are usually found in the TV menu.

CHECK FOR SOUND

1. Power on your TV.
2. If you are using a cable/satellite box or other secondary source:
 - a. Power on this source.
 - b. Select the appropriate TV input.
3. Power on the speaker (see page 21).

You hear sound coming from the speaker.
4. Press  on the speaker remote.

You don't hear sound coming from the TV speakers or speaker.

NOTE: If you don't hear sound coming from the speaker or do hear sound coming from your TV speakers, see page 44.

REMOTE FUNCTIONS

Use the remote to control the speaker and *Bluetooth* connections.

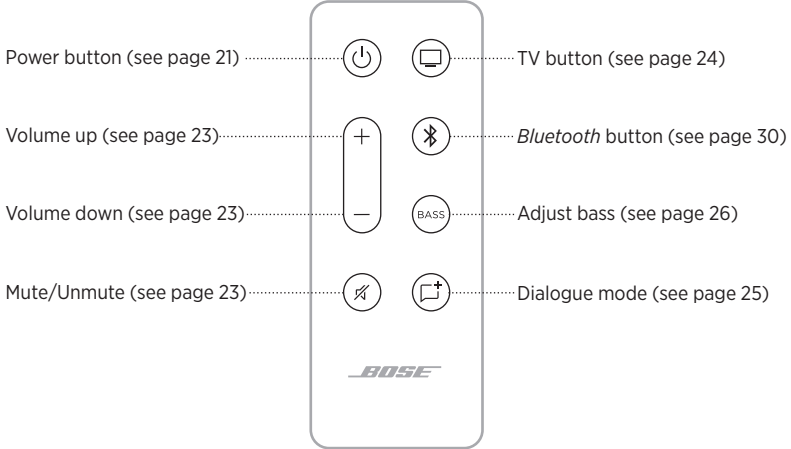

Power

On the remote, press the Power button  to power the speaker on/off.



When powered on, the speaker defaults to the last active source.

NOTES:

- When you plug the speaker into an AC (mains) outlet, the speaker automatically powers on.
- The first time the speaker is powered on, the speaker defaults to the TV  source.
- If the speaker is connected to the TV using an HDMI cable, the speaker changes to the TV source whenever the TV is powered on.

Auto-wake

You can set the speaker to power on whenever a sound signal is received from an optical or analog cable.

On the remote press and hold the Power button  until you hear a tone and the TV and *Bluetooth* lights on the speaker blink amber 3 times to switch between auto-wake and default power settings.

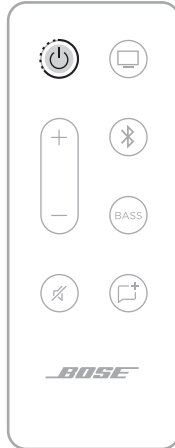

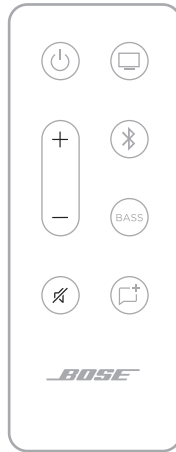

Volume



FUNCTION	WHAT TO DO
Volume up	Press +. NOTE: To quickly increase the volume, press and hold +.
Volume down	Press —. NOTE: To quickly decrease the volume, press and hold —.
Mute/Unmute	Press  . When audio is muted, the light on the speaker of the current source (TV or <i>Bluetooth</i>) pulses white until audio resumes (see page 34). TIP: You can also press + to resume audio.

Sources

You can control your TV and *Bluetooth* connections using your remote.

To control a source, press the button (TV button  or *Bluetooth* button ) on the remote for the source you want to control.

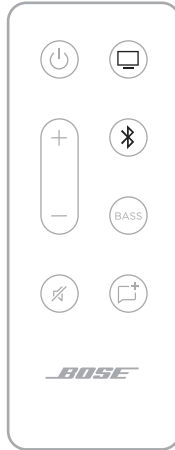

DIALOGUE MODE

Dialogue mode improves the clarity of dialogue and vocals in movies, TV programs, and podcasts by adjusting the audio balance of the system.

On the remote, press the Dialogue mode button  to switch between Dialogue mode and your default audio settings.

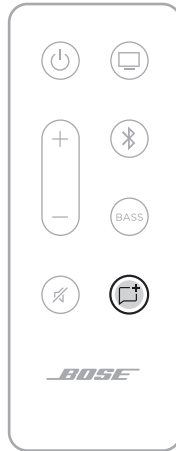

When Dialogue mode is enabled, the light for the current source glows green (see page 33).

NOTE: When you enable Dialogue mode, it stays enabled for your current source even if you switch to another source or turn off the speaker. To disable Dialogue mode for a source, press the Dialogue mode button  again.

ADJUST THE BASS

1. On the remote, press **BASS**.



On the speaker, the TV and *Bluetooth* lights blink white 3 times.

2. Adjust the bass by doing one of the following:
 - Press Volume up + to increase the bass.
 - Press Volume down — to decrease the bass.

The TV and *Bluetooth* lights on the speaker glow to show the current bass setting.

BASS SETTING	TV	Bluetooth
2 (maximum)	■	□
1	■	□
0 (default)	◀ □ ▶	◀ □ ▶
-1	□	■
-2 (minimum)	□	■

3. Press **BASS**.

The speaker saves the current bass setting.

NOTE: For optimal sound quality for dialogue-only programs, such as news and talk shows, see “Dialogue mode” on page 25.

RESET THE BASS

On the remote, press and hold **BASS** until the TV and *Bluetooth* lights on the speaker blink 3 times.



The bass settings reset to original factory settings.

PROGRAM A THIRD-PARTY REMOTE

You can program a third-party remote, such as your cable/satellite box remote, to control the volume of your speaker.

Put the speaker into program mode

On the speaker remote, press and hold the TV button  until the TV and *Bluetooth* lights on the speaker blink 3 times then glow solid white.

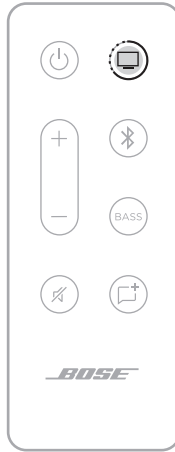

Program the TV remote

1. On the speaker remote, press the Volume up button +.

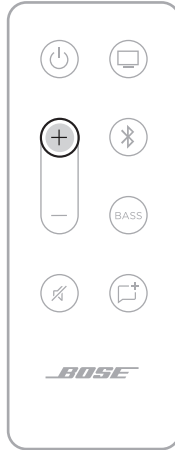

On the speaker, the TV and *Bluetooth* lights glow.

2. On your TV remote, press and hold Volume up for 2 seconds.

You hear a tone, and the TV light blinks amber twice then glows solid white.

NOTE: If unsuccessful, you hear a tone, and the TV blinks red twice then glows solid white. Repeat steps 1 - 2.

3. Repeat steps 1 - 2 using the Volume down button —.
4. Repeat steps 1 - 2 using the Mute button .

NOTE: Not all third-party remotes are compatible with the speaker. The remote must support IR (infrared) signals in order to control the speaker.

Bluetooth wireless technology lets you stream music from mobile devices such as smartphones, tablets, and laptop computers. Before you can stream music from a device, you must connect your device to the speaker.

CONNECT A MOBILE DEVICE

1. On the remote, press the *Bluetooth* button .



The *Bluetooth* light on the speaker slowly pulses blue.

2. On your mobile device, turn on the *Bluetooth* feature.

TIP: The *Bluetooth* menu is usually found in the Settings menu.

3. Select your speaker from the device list.



Once connected, you hear a tone. The *Bluetooth* light glows solid white. Bose TV Speaker appears in the mobile device list.

DISCONNECT A MOBILE DEVICE

Use your mobile device's *Bluetooth* menu to disconnect from the speaker.

TIP: You can also disable the *Bluetooth* feature on your mobile device to disconnect. Disabling the *Bluetooth* feature disconnects all other devices.

RECONNECT A MOBILE DEVICE

On the remote, press the *Bluetooth* button .

The speaker tries to reconnect with the most recently-connected device. When connecting, the *Bluetooth* light on the speaker blinks white.

NOTES:

- Make sure the *Bluetooth* feature is enabled on your mobile device.
- The device must be within 30 ft (9 m) of the speaker and powered on.

CONNECT AN ADDITIONAL MOBILE DEVICE

You can store up to eight devices in the speaker device list, and the speaker can be actively connected to two devices at a time.

NOTE: You can play audio from only one device at a time.

1. On the remote, press the *Bluetooth* button .



2. On your mobile device, select Bose TV Speaker from the device list.

NOTE: Make sure the *Bluetooth* feature is enabled on your mobile device.

CLEAR THE SPEAKER DEVICE LIST

1. On the remote, press and hold  for 10 seconds until you hear a tone.
2. Delete Bose TV Speaker from the *Bluetooth* list on your device.
All devices are cleared, and the speaker is ready to connect (see page 30).



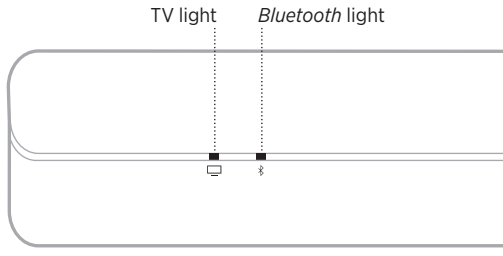





The LED lights located on the front of speaker show the speaker status.



NOTE: The lights display the current sources highest priority status.



























BLUETOOTH STATUS

Shows the *Bluetooth* connection status of mobile devices.

LIGHT ACTIVITY			SYSTEM STATE
Bluetooth light slowly pulses blue			Ready to connect
Bluetooth light blinks white			Connecting
Bluetooth light glows white			Connected





MEDIA PLAYBACK AND VOLUME STATUS

Shows the speaker status when controlling media playback and volume.

LIGHT ACTIVITY			SYSTEM STATE
TV light is solid white			Power on TV
<i>Bluetooth</i> light is solid white			Connected to a <i>Bluetooth</i> device
TV light is solid green			Dialogue mode enabled for TV
<i>Bluetooth</i> light is solid green			Dialogue mode enabled for <i>Bluetooth</i> -connected device
TV light blinks white			Changing volume for TV
<i>Bluetooth</i> light blinks white			Changing volume for <i>Bluetooth</i> -connected device
TV light blinks green			Changing volume in Dialogue mode for TV
<i>Bluetooth</i> light blinks green			Changing volume in Dialogue mode for <i>Bluetooth</i> -connected device
TV light slowly pulses white			Mute enabled for TV
<i>Bluetooth</i> light slowly pulses white			Mute enabled for <i>Bluetooth</i> -connected device
TV light slowly pulses green			Mute enabled in Dialogue mode for TV
<i>Bluetooth</i> light slowly pulses green			Mute enabled in Dialogue mode for <i>Bluetooth</i> -connected device

ERROR STATUS

Shows the status of error alerts.

LIGHT ACTIVITY			SYSTEM STATE
TV light blinks red			Speaker error - disconnect from power then reconnect. If error persists, contact Bose customer service

CONNECT ACCESSORIES (OPTIONAL)

You can connect these accessories to your speaker using a 3.5 mm audio cable (not provided). For more information, refer to your accessory owner's guide.

Bose Bass Module 500: worldwide.Bose.com/Support/BASS500

Bose Bass Module 700: worldwide.Bose.com/Support/BASS700

NOTE: Connect the bass module to the **BASS** port on the back of the speaker. Don't connect to the **AUX IN** port.

ROKU TV READY™

The Bose TV Speaker is Roku TV Ready certified. Connect the Bose TV Speaker to a Roku TV with an HDMI cable (not provided), and follow the on-screen setup instructions. Once completed, control the speaker with your Roku TV remote and access the speaker settings using the on-screen Roku TV settings menu.

NOTES:

- The Bose TV Speaker may require a software update to support Roku TV Ready. For more information, contact Bose customer service.

Visit: worldwide.bose.com/Support/TVS

- Roku TV Ready isn't available in all regions. For more information, visit: go.roku.com/rocutvready

NO OPTICAL OR HDMI PORT ON YOUR TV

Some TVs don't have optical or HDMI ports. Use an alternate setup method to connect your TV to the speaker.

PROBLEM	WHAT TO DO
TV only has an analog port	Connect your TV using a 3.5 mm to RCA stereo cable (not provided). See "TV only has an analog port."
TV only has a headphone port	Connect your TV using a 3.5 mm stereo cable (not provided). See "TV only has a headphone port" on page 39.

TV only has an analog port

If your TV only has analog ports (red and white), use a 3.5 mm to RCA stereo cable (not provided) to connect to the speaker.

1. If you haven't already, disconnect your TV from the speaker.
2. Insert the RCA analog cable into the Audio OUT RCA (red and white) ports on your TV.
3. Insert the stereo plug into the speaker's **AUX IN** connector.

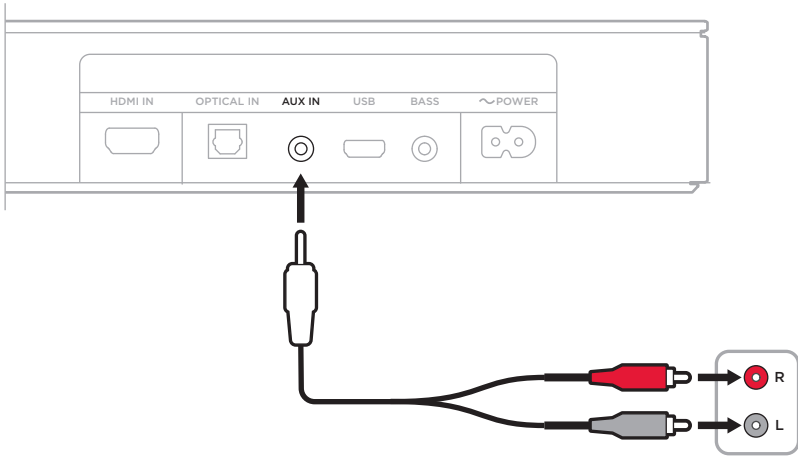

TV only has a headphone port

If your TV only has a headphone port, use a 3.5 mm stereo cable (not provided) to connect the speaker.

1. Insert one end of a 3.5 mm cable into the TV headphones port.
2. Insert the other end of the cable into the **AUX IN** port on the speaker.

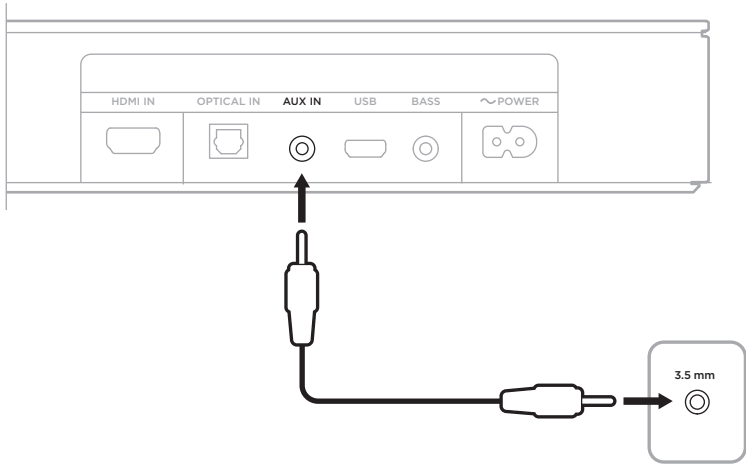

3. Make sure your TV speakers are on.
Refer to your TV owner's guide for more information.
4. To ensure optimal volume control from your speaker:
 - a. Set your TV volume to 75 percent of maximum.
 - b. Set the speaker volume using the speaker remote.

CONNECT A BOSE HOME SPEAKER OR SOUNDBAR

With Bose SimpleSync™ technology, you can connect your Bose TV Speaker to a Bose Home Speaker or Bose Soundbar to listen to the same song in two different rooms at the same time.

NOTE: SimpleSync™ technology has a *Bluetooth* range of 30 ft (9 m). Walls and construction materials can affect reception.

Compatible products

You can connect your Bose TV Speaker to any member of the Bose Home Speaker family.

Popular compatible products include:

- Bose Smart Soundbar 700
- Bose Soundbar 500
- Bose Home Speaker 500
- Bose Home Speaker 300
- Bose Portable Home Speaker

New products are added periodically. For a complete list and more information, visit: worldwide.bose.com/Support/Groups

Connect using the Bose Music app

1. On your Bose TV Speaker remote, press and hold the *Bluetooth* button ⌘ until the *Bluetooth* light on your Bose TV Speaker blinks blue.
2. Use the Bose Music app to connect your speaker to a compatible Bose product. For more information, visit: worldwide.bose.com/Support/Groups

NOTES:

- Make sure that your Bose TV Speaker is within 30 ft (9 m) of your Bose Home Speaker or Bose Soundbar.
- You can connect your Bose TV Speaker to only one product at a time.

RECONNECT TO A BOSE HOME SPEAKER OR SOUNDBAR

Power on your Bose TV Speaker (see page 21).

Your Bose TV Speaker tries to connect to the two most recently-connected *Bluetooth* devices, including your Bose Home Speaker or Bose Soundbar.

NOTES:

- Your Bose Home Speaker or Bose Soundbar must be within range (30 ft or 9 m) and powered on.
- If your Bose TV Speaker doesn't connect, connect using the Bose Music app. You can access this option from the Settings menu.

REPLACE THE REMOTE BATTERY

1. Using a coin, turn the battery compartment cover left (counter-clockwise), and remove the cover.

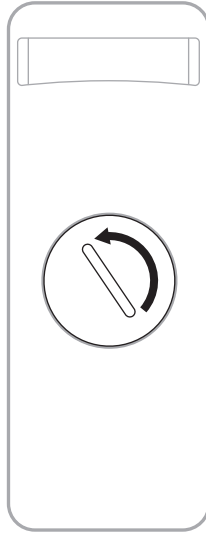

2. Insert the new battery flat side up, with the + symbol facing up.

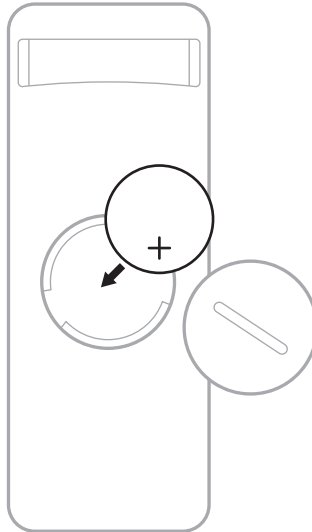

NOTE: Use only an agency approved (e.g., UL) CR2032 or DL2032 3-volt lithium battery.

3. Reset the cover and turn it right (clockwise) to lock in place.

CLEAN THE SPEAKER

Clean the exterior of the speaker with a soft dry cloth.

CAUTIONS:

- Do NOT allow liquids to spill onto the speaker or into any openings.
- Do NOT blow air into the speaker.
- Do NOT use a vacuum to clean the speaker.
- Do NOT use any sprays near the speaker.
- Do NOT use any solvents, chemicals, or cleaning solutions containing alcohol, ammonia, or abrasives.
- Do NOT allow objects to drop into any openings.

REPLACEMENT PARTS AND ACCESSORIES

Replacement parts and accessories can be ordered through Bose customer service.

Visit: worldwide.bose.com/Support/TVS

LIMITED WARRANTY

The speaker is covered by a limited warranty. Visit our website at global.bose.com/warranty for details of the limited warranty.

To register your product, visit global.bose.com/register for instructions. Failure to register will not affect your limited warranty rights.

TRY THESE SOLUTIONS FIRST

If you experience problems with the speaker:

- Make sure the speaker is connected to a live AC (mains) outlet.
- Secure all cables and make sure all connections are correct.
- Check the status lights (see page 33).
- Move the speaker away 1 – 3 ft (0.3 – 0.9 m) from possible interference (wireless routers, cordless phones, televisions, microwaves, etc.).
- Place the speaker according to the placement guidelines (see page 13).



OTHER SOLUTIONS

If you could not resolve your issue, see the table below to identify symptoms and solutions to common problems. If you are unable to resolve your issue, contact Bose customer service.

Visit: worldwide.Bose.com/contact

SYMPTOM	SOLUTION
No HDMI ARC or optical port on your TV	Use an alternate setup method to connect your TV to the speaker (see page 38).
Speaker doesn't power on	<p>Plug the power cord into a different AC (mains) outlet.</p> <p>Use the remote to power on the speaker (see page 21).</p> <p>Unplug the power cords for the speaker and optional bass module, wait 30 seconds, and plug them firmly into a live AC (mains) outlet.</p>
Remote is inconsistent or doesn't work	<p>Replace the battery (see page 42).</p> <p>Make sure the remote is within 20 ft (6 m) of the speaker.</p> <p>Make sure there are no obstructions between the remote and the speaker.</p> <p>Make sure you are in the correct source by pressing the volume button on the remote to see if the correct source light on the speaker flashes.</p>

SYMPTOM	SOLUTION
<p>Intermittent or no audio from speaker</p>	<p>If the TV light or the <i>Bluetooth</i> light are pulsing, the speaker is muted. Press the Mute button  to unmute the speaker.</p> <p>Make sure your mobile device isn't muted.</p> <p>Increase the volume on the speaker (see page 23) or your mobile device.</p> <p>Switch to a different source (see page 24).</p> <p>Play audio from a different application or music service.</p> <p>Restart your mobile device.</p> <p>Make sure you're using a compatible <i>Bluetooth</i> mobile device.</p> <p>Make sure that the speaker's HDMI cable is inserted into a port on your TV labeled HDMI ARC (Audio Return Channel), not a standard HDMI port. If your TV doesn't have an HDMI ARC port, connect the speaker using an optical cable (see page 15).</p> <p>If the speaker is connected to your TV's HDMI ARC port, make sure that Consumer Electronics Control (CEC) is enabled in your TV system menu. Your TV may refer to CEC by a different name. Refer to your TV owner's guide.</p> <p>Power off your TV, disconnect the speaker's HDMI cable from your TV's HDMI ARC port and reconnect it. Power on your TV.</p> <p>Insert the optical cable into a port on your TV labeled Output or OUT, not Input or IN.</p> <p>Unplug the power cords for the speaker and optional bass module, wait 30 seconds, and plug them firmly into a live AC (mains) outlet.</p>
<p>No audio from bass module</p>	<p>Make sure your bass module is connected to power.</p> <p>Make sure the bass module is connected to the BASS port on the back of the speaker.</p> <p>Make sure your bass module is compatible with the speaker (see page 36).</p> <p>Adjust the bass level (see page 26).</p> <p>Switch to a different source (see page 24).</p>

SYMPTOM	SOLUTION
<p>Sound is coming from TV speaker</p>	<p>Make sure that the speaker's HDMI cable is inserted into a port on your TV labeled ARC (Audio Return Channel). If your TV doesn't have an HDMI ARC port, connect to the speaker using the optical cable (see page 16).</p> <p>Turn off your TV speakers. Refer to your TV owner's guide.</p> <p>If the speaker is connected to your TV's HDMI ARC port, make sure that Consumer Electronics Control (CEC) is enabled in your TV system menu. Your TV may refer to CEC by a different name. Refer to your TV owner's guide.</p> <p>Disconnect the speaker's HDMI cable from your TV's HDMI ARC port and reconnect it.</p> <p>Decrease your TV volume to its lowest setting.</p> <p>Connect to the speaker using both an HDMI cable (see page 17) and the optical cable (see page 16).</p>
<p>Poor or distorted audio</p>	<p>Test different sources if available.</p> <p>Make sure that your TV can output surround sound audio. Refer to your TV owner's guide.</p> <p>If the audio is being played from another device, reduce the volume of that device.</p> <p>Power off your TV speakers. Refer to your TV owner's guide.</p> <p>If your speaker is wall mounted, adjust the audio using the remote (see page 14).</p>
<p>Speaker and source don't power on/off simultaneously</p>	<p>On the remote, press the source button for the source that is out of sync.</p> <p>Press the Power button  to power on/off the source.</p>
<p>Speaker doesn't connect with Bluetooth device</p>	<p>On your mobile device, turn the <i>Bluetooth</i> feature off and then on. Delete the speaker from the <i>Bluetooth</i> list. Connect again (see page 30).</p> <p>Connect a different mobile device (see page 32).</p> <p>Make sure you're using a compatible <i>Bluetooth</i> mobile device.</p> <p>You can't connect <i>Bluetooth</i> headphones to the speaker.</p> <p>Remove the speaker from your mobile device <i>Bluetooth</i> list. Connect again (see page 30).</p> <p>Clear the speaker device list (see page 32). Connect again (see page 30).</p>
<p>Speaker doesn't pair with a Bose Home Speaker or Bose Soundbar</p>	<p>On the speaker remote, press the <i>Bluetooth</i> button .</p> <p>Make sure that your Bose TV Speaker is within 30 ft (9 m) of your Bose Home Speaker or Bose Soundbar.</p>

SYMPTOM

SOLUTION

**Speaker doesn't
reconnect to a
previously-paired
Bose Home Speaker
or Bose Soundbar**

Connect using the Bose Music app. You can access this option from the Settings menu.



852004-0010