

HD 350BT

Around-ear headphones

Model: SEBT3



Instruction manual

Use the search function, the navigation (left) or the following links:

Start

“Product overview”

“Getting started”

“Using the headphones”

“FAQ/If a problem occurs ...”

“Specifications”



Sennheiser electronic GmbH & Co. KG

Am Labor 1

30900 Wedemark

Germany



www.sennheiser.com

Version: 02/21 A04

Important safety instructions

- ▷ Read this instruction manual carefully and completely before using the product.
- ▷ Always include this instruction manual when passing the product on to third parties.
- ▷ Do not use the product if it is obviously defective or makes loud, unusual (whistling or beeping) noise.
- ▷ Only use the product in environments where Bluetooth® wireless transmission is permitted.

Preventing damage to health and accidents

- ▷ Protect your hearing from high volume levels. Permanent hearing damage may occur when headphones are used at high volume levels for long periods of time. Sennheiser headphones sound exceptionally good at low and medium volume levels. 
- ▷ The product generates stronger permanent magnetic fields that could cause interference with cardiac pacemakers, implanted defibrillators (ICDs) and other implants. Always maintain a distance of at least 3.94"/10 cm between the product component containing the magnet and the cardiac pacemaker, implanted defibrillator, or other implant. 
- ▷ Keep the product, accessories and packaging parts out of reach of children and pets to prevent accidents. Swallowing and choking hazard.
- ▷ Do not use the product in an environment that requires your special attention (e.g. in traffic or when performing skilled jobs).

Preventing damage to the product and malfunctions

- ▷ Always keep the product dry and do not expose it to extreme temperatures (hairdryer, heater, extended exposure to sunlight, etc.) to avoid corrosion or deformation. The normal operating temperature is from 0 to 40 °C/32 to 104 °F.
- ▷ Use only attachments/accessories/spare parts supplied or recommended by Sennheiser.
- ▷ Clean the product only with a soft, dry cloth.
- ▷ Use the product with care and store it in a clean, dust-free environment.

Safety instructions for the lithium polymer rechargeable battery









WARNING

If abused or misused, the rechargeable batteries may leak. In extreme cases, they may even present a risk of:

- heat generation,
- fire development,
- explosion,
- smoke or gas development.

Important safety instructions

	Only use rechargeable batteries and chargers recommended by Sennheiser.
	Only charge the product / rechargeable batteries at ambient temperatures between +10 °C to +40 °C/50 °F to 104 °F.
	Do not heat the product / rechargeable batteries above +70 °C/140 °F. Avoid exposure to sunlight and do not throw the product / rechargeable batteries into fire.
	When not using the product / rechargeable batteries for extended periods of time, charge them regularly (about every three months).
	Switch rechargeable battery-powered products off after use.
	Dispose of defective products with built-in rechargeable batteries at special collection points or return them to your specialist dealer.

Notes on data collection and processing and on firmware updates

This product stores individual settings such as the volume and the Bluetooth addresses of paired devices. This data is required for the operation of the product and is not transferred to Sennheiser or companies commissioned by Sennheiser and is not processed.

Using the “Sennheiser Smart Control” app, you can update the firmware of the product for free via an Internet connection. If the device on which the app is installed is connected to the Internet, the following data is automatically transferred to and processed by Sennheiser servers in order to provide and transfer suitable firmware updates: hardware identifier, hardware revision number, firmware version of the product, operating system type (Android, iOS) and version, version of the app. The data will only be used as specified and will not be stored permanently.

If you do not want this data to be transferred and processed, do not connect to the Internet.

Intended use/Liability

These headphones have been designed as an accessory for Bluetooth compliant devices. They are intended for wireless audio communication such as music playback and phone calls via Bluetooth wireless technology.

It is considered improper use when the product is used for any application not named in the corresponding product documentation.

Sennheiser does not accept liability for damage arising from misuse or improper use of this product and its attachments/accessories.

Sennheiser is not liable for damages to USB devices that are not consistent with the USB specifications.

Sennheiser is not liable for damages resulting from the loss of connection due to flat or overaged rechargeable batteries or exceeding the Bluetooth transmission range.

Before putting into operation, please observe the respective country-specific regulations.

Package contents



HD 350BT around-ear headphones
Model: SEBT3



USB charging cable with USB-C and USB-A connector



Quick guide



Safety guide



Online you can find:

- this detailed instruction manual and additional information www.sennheiser.com/download
- the Sennheiser Smart Control app for configuring the headphones and for additional functions www.sennheiser.com/smart-control



A list of accessories can be found on the HD 350BT product page at www.sennheiser.com. Contact your local Sennheiser partner: www.sennheiser.com/service-support.

Product overview

HD 350BT model: SEBT3

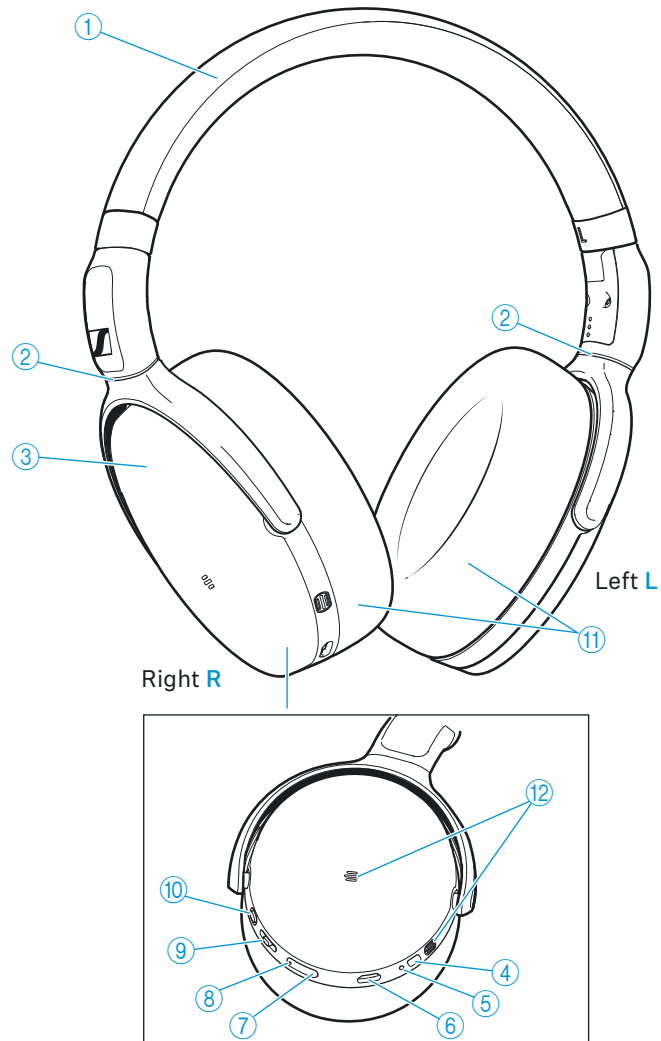





- ① Headband
- ② Ear cup joints
- ③ Ear cups, steplessly adjustable
- ④ On/off button
pressing for 4 seconds activates the Bluetooth pairing mode
- ⑤ LED
- ⑥ USB-C socket for charging
- ⑦ Volume – button (volume down)
- ⑧ Volume + button (volume up)



- ⑨ 3-way multi-function button for music and call functions
- ⑩ Voice assistant button
- ⑪ Ear pads
- ⑫ Speech microphones (2 pcs.) for phone calls

Overview of the LED display

During operation

LED		Meaning; the headphones
 3x	flashes blue 3x	switch on
 3x	flashes blue 3x	are connected to a device via Bluetooth
	flashes red/blue	are in Bluetooth pairing mode
 3x	flashes red 3x	are not connected to a device via Bluetooth or the connection has been lost

During phone calls

LED		Meaning
	flashes blue	Incoming call
	flashes red	Incoming call and the rechargeable battery of the headphones is almost empty

i If the LED does not light up immediately during charging, clean the charging socket and charge the headphones until the LED lights up again (> 11).

Notes on voice prompts

The headphones output voice prompts for various functions (see examples below).

Voice prompt	Meaning/headphones
“Power on”	are switched on
“Power off”	are switched off
“Connected”	are connected via Bluetooth
“Lost connection”	are not connected via Bluetooth
“Call rejected”	incoming call rejected
“Call ended”	call ended
“More than xx hours playtime”	Rechargeable battery has the stated charge level
“Recharge headset”	Rechargeable battery is empty. Recharge the headphones.

Notes on beeps/acoustic signals

The headphones output beeps/acoustic signals for the following functions.

Acoustic signal	Meaning/headphones...
2x low-pitched beep	minimum volume is reached
2x high-pitched beep	maximum volume is reached

Getting started

1. Charging the rechargeable battery

The headphones' rechargeable battery is not fully charged upon delivery. Before using the headphones for the first time, charge the rechargeable battery for a complete charging cycle without interruption (> 11).

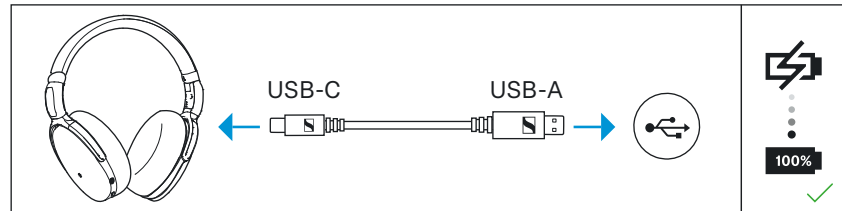

2. Installing the Smart Control app on your smartphone

The Sennheiser Smart Control app allows you to use all functions and settings of the headphones and to e.g. adjust the sound to your liking using the equalizer (> 15).



3. Connecting the headphones to a Bluetooth device

Connect the headphones to your smartphone via Bluetooth (> 12).

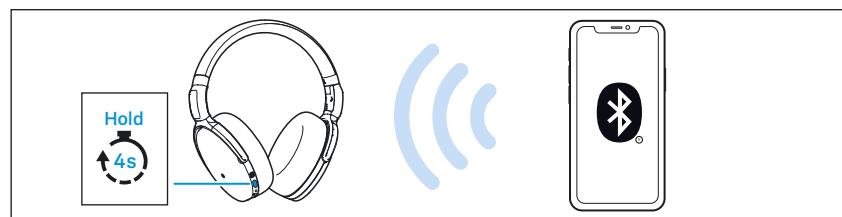

4. Putting the headphones on and adjusting the headband

For good sound quality and best possible wearing comfort, the headband can be adjusted to properly fit your head (> 17).

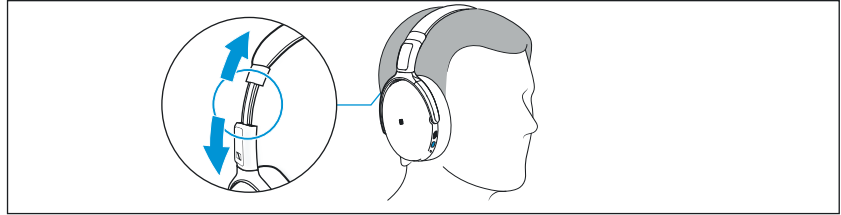

Using the headphones

Information on the rechargeable battery and the charging process

The headphones have a built-in rechargeable battery. A complete charging cycle takes up to 2 hours. Before using the headphones for the first time, charge the rechargeable battery for a complete charging cycle without interruption.

When the headphones are being charged, the LED lights up (> 7). Once the headphones are fully charged, the LED flashes blue for 5 minutes and then goes off. When the battery charge drops to a critical level, a voice prompt asks you to recharge the headphones (“Recharge headset”).

Sennheiser recommends using the supplied USB cable and a compatible standard USB power supply for charging the headphones.

While the headphones are being charged, you can still listen to music or make phone calls. In this case, however, the charging time may be longer.

Charging the headphones' rechargeable battery

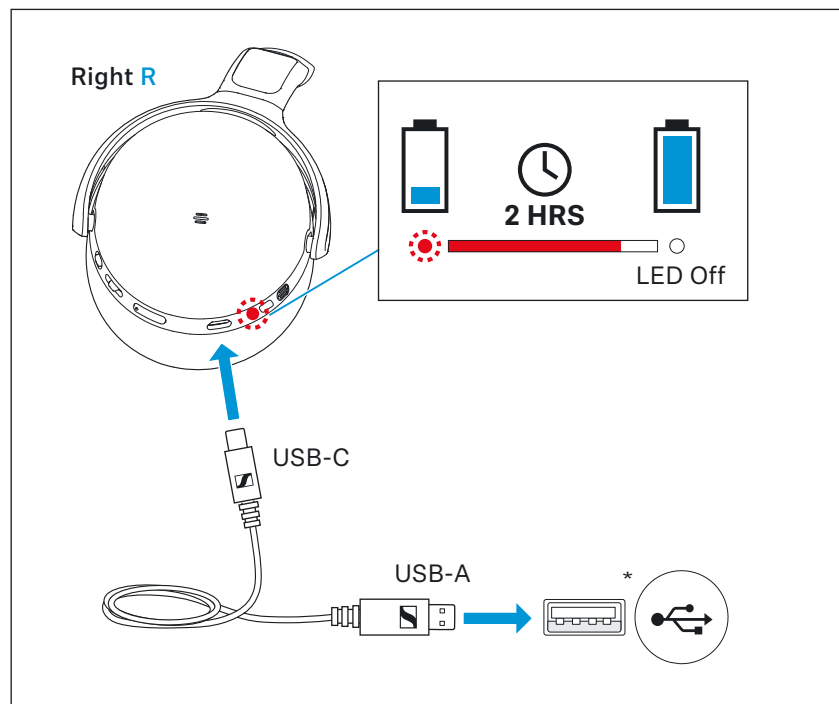

1. Connect the USB-C connector of the charging cable to the USB socket of the headphones.
2. Connect the USB-A connector to a corresponding socket of a USB power source (to be ordered separately). Make sure that the USB power source is connected to the power supply system. The charging process of the headphones begins. The LED displays the charge status:

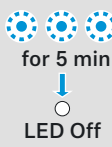
LED		Meaning
	lights up red	Rechargeable battery is being charged
	flashes blue for 5 minutes, the LED then goes off	Rechargeable battery is fully charged

i If the LED does not light up immediately during charging, clean the charging socket and charge the headphones until the LED lights up again (> 11).

i You can speed up the charging process by charging the headphones when they are switched off.

Connecting the headphones to a Bluetooth device

To be able to use the Bluetooth connection, you must register both devices (headphones and e.g. smartphone) once. This process is called pairing.

If operation differs from the steps mentioned, also refer to the instruction manual of the Bluetooth device you are using.

i When you switch on the headphones for the first time, they automatically switch to pairing mode.

Information on the Bluetooth wireless connection

The headphones are compatible with Bluetooth 5.0.

If your audio source supports one of the following high-resolution audio encoding methods, music is automatically played in high audio quality: aptX, aptX LL or AAC. Otherwise the headphones will play your music in normal audio quality (SBC).

Paired devices establish the Bluetooth wireless connection immediately after switch-on and are ready for use.

On switch-on, the headphones automatically try to connect to the last two connected Bluetooth devices. The headphones can save the connection profiles of up to eight Bluetooth devices with which they have been paired. Audio playback is only possible from one device at a time.

If you pair the headphones with the ninth Bluetooth device, the saved connection profile of the least used Bluetooth device will be overwritten. If you want to re-establish a connection with the overwritten Bluetooth device, you have to pair the headphones again.

Using the headphones

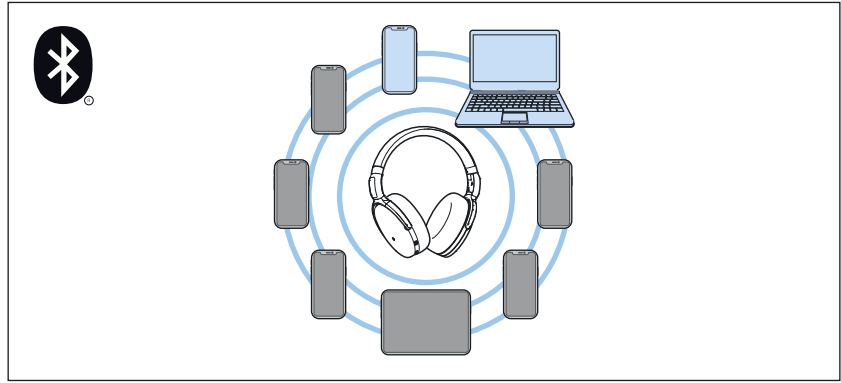

Paired and connected Bluetooth device



Paired Bluetooth device (currently not connected)

Pairing the headphones with a Bluetooth device

1. Switch the headphones off and place them close to the Bluetooth device (max. 20 cm).
2. Press and hold the on/off button for 4 seconds.
The LED flashes red and blue. The headphones are in pairing mode.
3. Activate Bluetooth on your Bluetooth device.
4. Via the menu of your Bluetooth device, start the search for new Bluetooth devices.
All active Bluetooth devices in the proximity of your Bluetooth device are displayed.
5. From the list of found Bluetooth devices, select "HD 350BT". If necessary, enter the default pin code "0000".
6. If pairing was successful, you hear the voice prompt "Connected".
The LED flashes blue 3x.

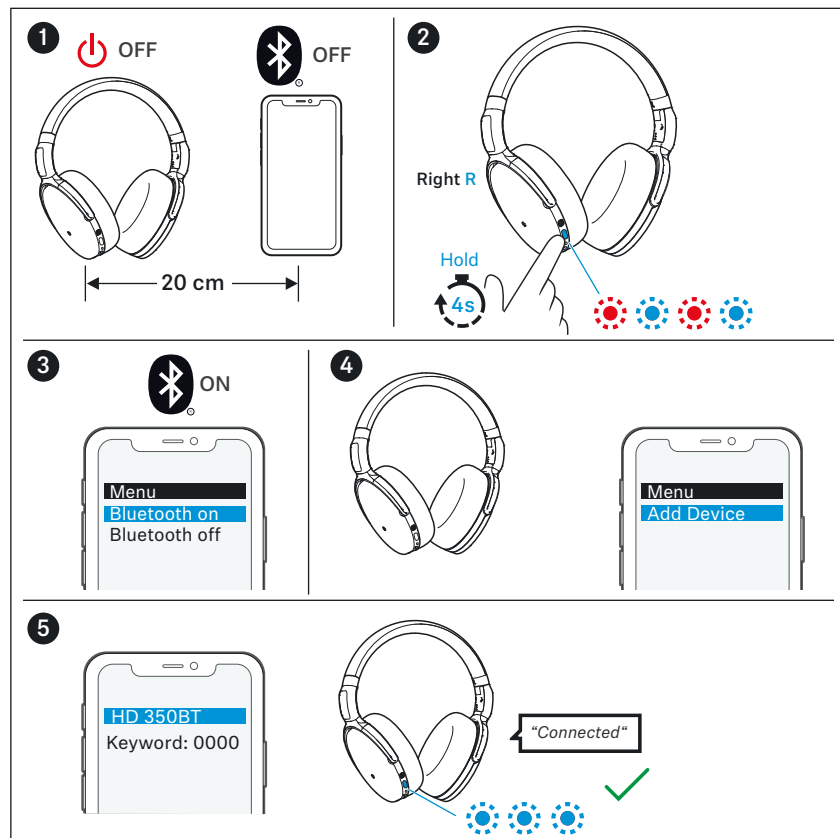

i If no connection is established within 5 minutes, pairing mode is terminated and the headphones switch to standby mode. If necessary, repeat the steps described above.

i If you switch on the headphones for the first time (the pairing list is empty), they automatically switch to pairing mode.

Disconnecting the headphones from a Bluetooth device

- ▷ Via the menu of your Bluetooth device, disconnect the connection to the headphones.
The headphones are disconnected from the Bluetooth device. You hear the voice prompt “Lost connection”. The headphones switch to standby mode.

i To delete the Bluetooth pairing list of the headphones, > 27.

Installing the Smart Control app

To make full use of all the settings and functions of the headphones, you need to have the free Sennheiser Smart Control app installed on your smartphone.

Download the app from the App Store or Google Play and install it on your smartphone. Alternatively, you can use your smartphone to scan the following QR code or to call up the following Internet site:

www.sennheiser.com/smartcontrol



- ▷ Connect your smartphone to the headphones via Bluetooth (> 12).
- ▷ Start the Smart Control app.
- ▷ Follow the instructions in the app.
The Smart Control app recognizes the headphones and activates all available settings and functions.

Switching the headphones on



WARNING

Danger of hearing damage due to high volume levels!

Listening at high volume levels can lead to permanent hearing defects.

- ▷ Before putting the headphones on, adjust the volume to a low level (> 19).
- ▷ Do not continuously expose yourself to high volume levels.

1. Unfold both ear cups.
The joints click into place.
2. Press and hold the on/off button for 2 seconds.
The LED flashes blue 3x. You hear the voice prompt “Power on”.
If Bluetooth is activated on the headphones and a paired device is available, the LED flashes blue 3x and you hear the voice prompt “Connected”.



- i** Make sure that Bluetooth is already activated on your Bluetooth device when switching on the headphones.
- i** If Bluetooth is activated and the headphones cannot find a paired Bluetooth device within a few minutes, you hear the voice prompt “Lost connection”. The LED flashes red 3x. The headphones switch to standby mode.

Switching the headphones off

1. Press and hold the on/off button for 2 seconds.
2. You hear the voice prompt “Power off” and the LED flashes red 3x. The headphones switch off.

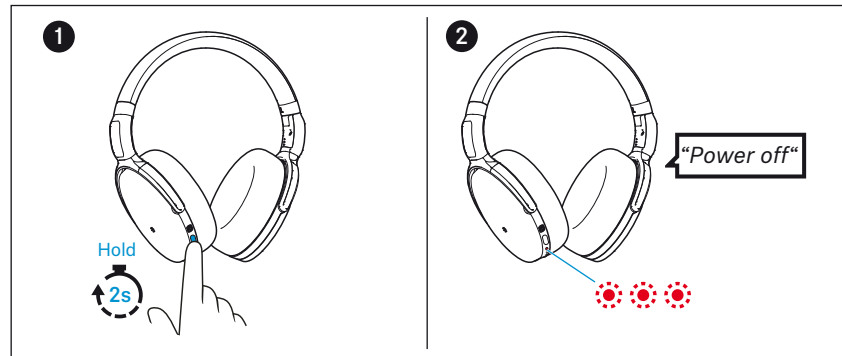

Putting the headphones on and adjusting the headband

For good sound quality and best possible wearing comfort, the headband can be adjusted to properly fit your head.

- ▷ Wear the headphones so that the headband runs over the top of your head. The markings **R** for the right side and **L** for the left side can be found on the inside of the headband.
- ▷ Move the ear cups up or down the headband slider until:
 - your ears are comfortably covered by the ear pads,
 - you feel even, gentle pressure around your ears,
 - a snug fit of the headband on the head is ensured.

For optimal sound quality, the ear pads must completely surround your ears.

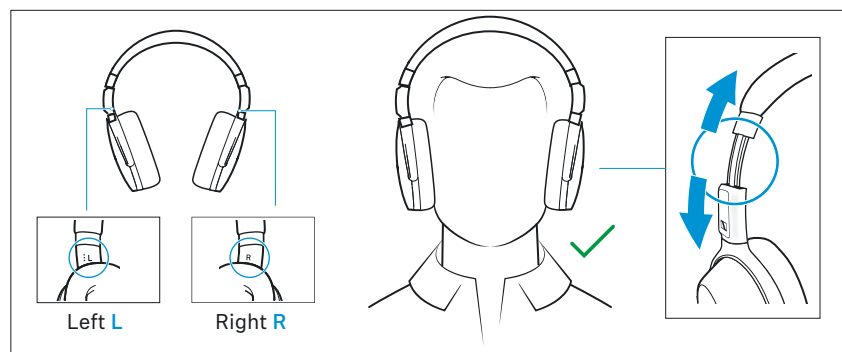

Retrieving information on the battery charge status

When the headphones are connected to your Bluetooth device, the battery charge status can be displayed on the screen of your smart-phone (depending on the device and operating system used).

The Smart Control app also displays the battery charge status.

You can retrieve information on the battery charge status on the headphones by pressing the center of the volume button 1x.

Voice prompt	Meaning
“Recharge headset”	The rechargeable battery is empty. Recharge the rechargeable battery (> 11).
“More than xx hours playtime”	The remaining battery charge is displayed in hours.

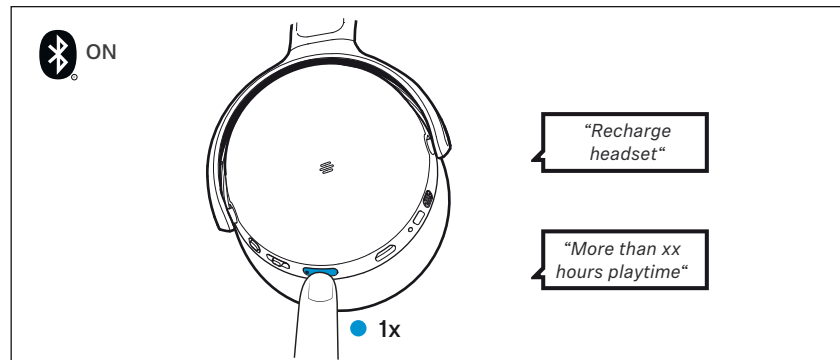

Adjusting the volume



WARNING

Danger of hearing damage due to high volume levels!

Listening at high volume levels can lead to permanent hearing defects. Toggling between the audio sources may cause enormous volume jumps that can permanently damage your hearing.

- ▷ Before putting the headphones on and before toggling between audio sources, adjust the volume to a low level.
- ▷ Do not continuously expose yourself to high volume levels.

You can adjust the playback volume for music and for phone calls.

- ▷ If you are playing music or are on a call: Press the rear part or the front part of the volume button to increase or reduce the volume for music and phone calls.

When the maximum or minimum volume is reached, you hear a beep.

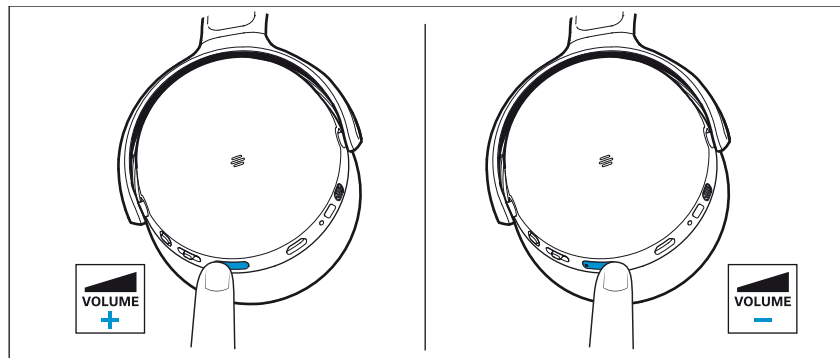

You can also adjust the volume using the connected Bluetooth device.

Controlling music playback

The following music playback functions are only available when the headphones and the device are connected via Bluetooth. Some smartphones or music players may not support all functions.

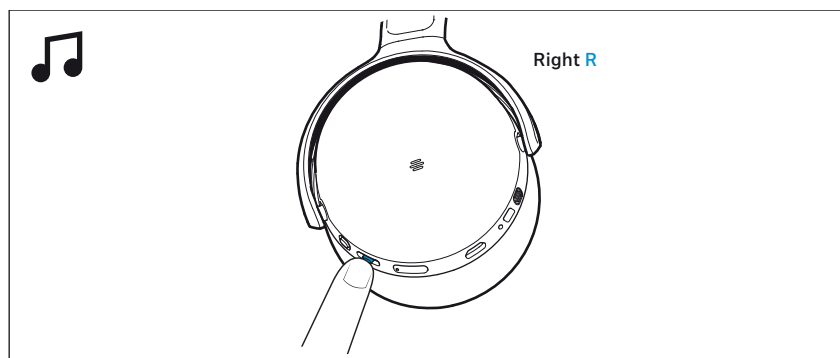

Playing/pausing music

- ▷ Press the center of the 3-way multi-function button 1x.

3-way multi-function button		Function
	Press 1x ●	Plays or pauses music

Playing the next track

- ▷ Slide the 3-way multi-function button backwards.

3-way multi-function button		Function
	Slide backwards ←	Plays the next track in the playlist

Playing the previous track

- ▷ Slide the 3-way multi-function button forwards.

3-way multi-function button		Function
	Slide forwards →	Plays the previous track in the playlist

Making phone calls using the headphones

The following call functions are only available when the headphones and smartphone are connected via Bluetooth. Some smartphones or communication apps may not support all functions.

Making a call

- ▷ Dial the desired number on your smartphone.
If your smartphone does not automatically transfer the call to the headphones, select “HD 350BT” as the output device on your smartphone (see the instruction manual of your smartphone if necessary).

Accepting/rejecting/ending a call

If your headphones are connected to a smartphone and you receive a call, you hear a ring tone in the headphones.

If you are playing music when you receive a call, the music pauses until you end the call.

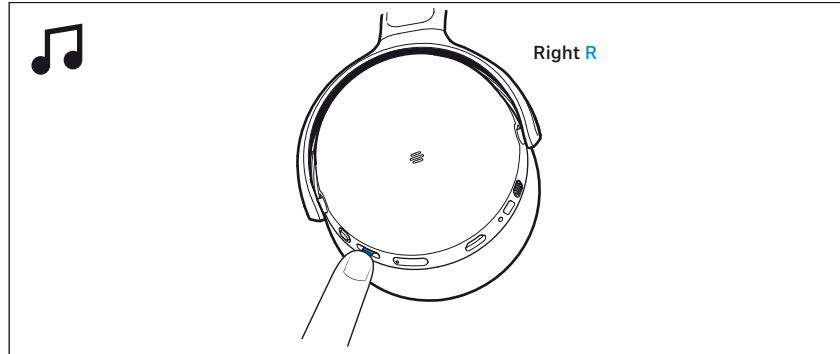

3-way multi-function button	Function
	Press 1x ● Accepts a call
	Press 1x ● Ends a call Voice prompt "Call ended"
	Hold for 2 sec ▬ Rejects a call Voice prompt "Call rejected"
	Press 2x ● ● Redialing Voice prompt "Redial" (only when music playback is NOT active)
	Hold for 2 sec ▬ Continues the active call and rejects an incoming call
	Press 1x ● Puts the active call on hold and accepts an incoming call
	Press 2x ● ● Ends the active call and accepts an incoming call
	Press 2x ● ● Toggles between active call and call on hold

Using the voice assistant/voice dialing

- ▷ Press the voice assistant button 1x.
The available voice assistant of your smartphone is activated (depending on the system or app on your smartphone: Siri, Google Assistant, or others. If no voice assistant is available, voice dialing may be activated).
- ▷ Ask the voice assistant your question or make a request.

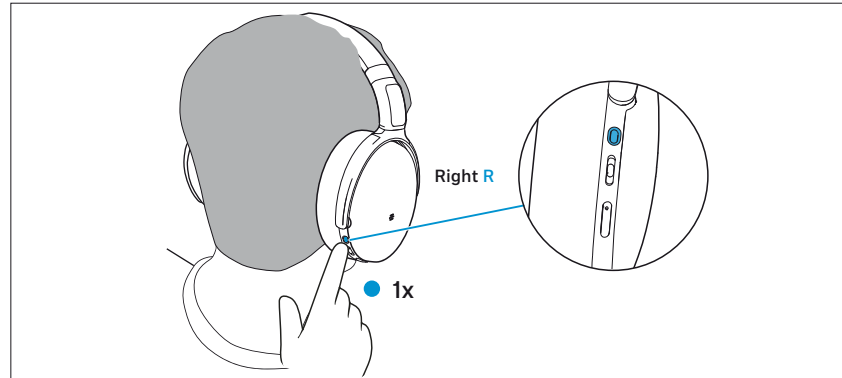

To cancel the voice assistant/voice dialing:

- ▷ Press the voice assistant button 1x.

Adjusting sound effects/the equalizer

To be able to use the sound effects/equalizer, you require the Smart Control app (> 15).

- ▷ In the Smart Control app, select the desired sound effects.
The sound effects are stored in the headphones. These sound settings are active even without using the Smart Control app, i.e. when you are using another Bluetooth device.

Storing and transporting the headphones

▷ Fold up the headphones.

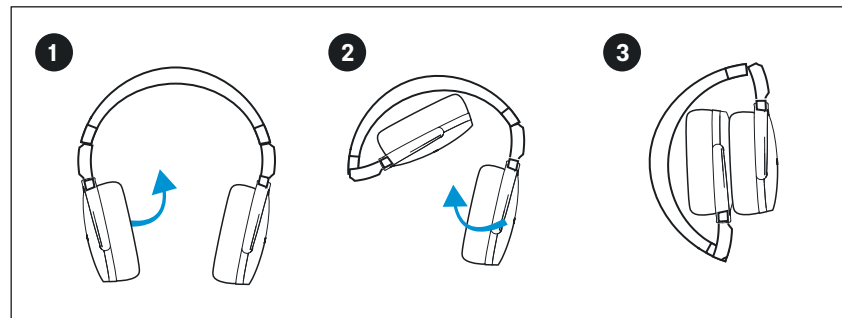

Care and maintenance

CAUTION

Liquids can damage the electronics of the product!

Liquids entering the housing of the product can cause a short-circuit and damage the electronics.

- ▷ Keep all liquids far away from the product.
 - ▷ Do not use any solvents or cleansing agents.
-
- ▷ Clean the parts of the product only with a soft, dry cloth.

Replacing the ear pads

For reasons of hygiene, you should replace the ear pads from time to time. Spare ear pads are available from your Sennheiser partner.

1. Peel the ear pad up and away from the ear cup.
2. Assign the right ear pad to the right ear cup and the left ear pad to the left ear cup.
3. Place the new ear pad onto the ear cup. Make sure that the seam of the ear pad points downwards.
4. Place the ear pad around the ear cup so that the ear pad is fixed in the notch of the ear cup.

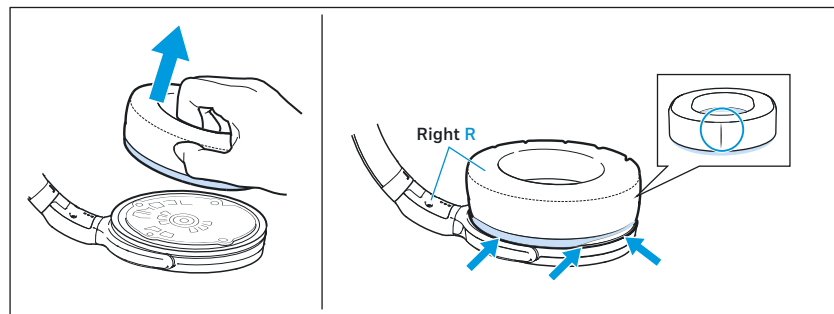

Information on the built-in rechargeable battery

Sennheiser ensures and guarantees that the rechargeable batteries perform at their optimum upon purchase of the product. If, upon purchase or within the warranty period, you suspect that a rechargeable battery is obviously defective or if a charging error/battery error is displayed (> 7), stop using the product, disconnect it from the power supply system and contact your Sennheiser partner. Your Sennheiser partner will coordinate the repair/replacement with you.

Do not return a product with a defective battery to your dealer or Sennheiser partner unless requested to do so. To find a Sennheiser partner in your country, search at www.sennheiser.com/service-support.

Outside the warranty period, you can have the rechargeable battery replaced for a fee by your Sennheiser service partner. Contact your local Sennheiser partner: www.sennheiser.com/service-support.

Installing firmware updates

Firmware updates can be downloaded free of charge from the Internet using the Sennheiser Smart Control app. Sennheiser recommends to always install the latest firmware version to ensure the best performance of your product.

- ▷ Connect the headphones to your smartphone and start the Smart Control app (> 15).
- ▷ The app provides information on available firmware updates and guides you through the installation process.

FAQ/If a problem occurs ...



Current list of frequently asked questions (FAQ)

Visit the HD 350BT product page at

www.sennheiser.com/download

There you will find a current list of frequently asked questions (FAQ) and suggested solutions.

Your question has not been answered or the problem persists?

If a problem occurs that is not listed in the FAQ section or if the problem cannot be solved with the proposed solutions, please contact your Sennheiser partner for assistance.

To find a Sennheiser partner in your country, search at

www.sennheiser.com/service-support.

Leaving the Bluetooth transmission range

Wireless calling and streaming are only possible in the Bluetooth transmission range of your smartphone. The transmission range largely depends on environmental conditions such as wall thickness, wall composition etc. With a free line of sight, the transmission range of most smartphones and Bluetooth devices is up to 10 meters. If you, and therefore the headphones, leave the Bluetooth transmission range of the smartphone, the sound quality deteriorates increasingly until you hear the voice prompt “Lost connection” and the connection breaks down completely. If you immediately re-enter the Bluetooth transmission range, the connection is automatically re-established.

Resetting the headphones

If the function of the headphones is disturbed, perform a reset. Individual settings such as the pairing settings are not deleted.

1. Connect the USB-C cable to the headphones and make sure that the headphones are being charged (> 11).
2. Simultaneously press and hold the one/off button and the rear part of the volume button (Volume +) for at least 5 seconds. The reset is completed. Continue to use the headphones as normal.

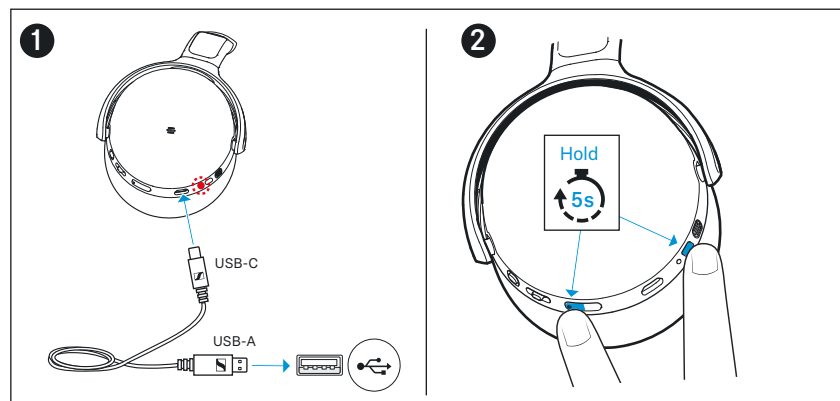

Deleting the Bluetooth pairing list of the headphones

1. Switch off the headphones (press and hold the on/off button for 2 seconds) and then start pairing mode (press and hold the on/off button for 4 seconds) (> 17 and 14).
2. Simultaneously press and hold the on/off button and the 3-way multi-function button for 3 seconds.
The LED on the headphones flashes purple 3x. The pairing list is deleted. The headphones then stay in Bluetooth pairing mode.

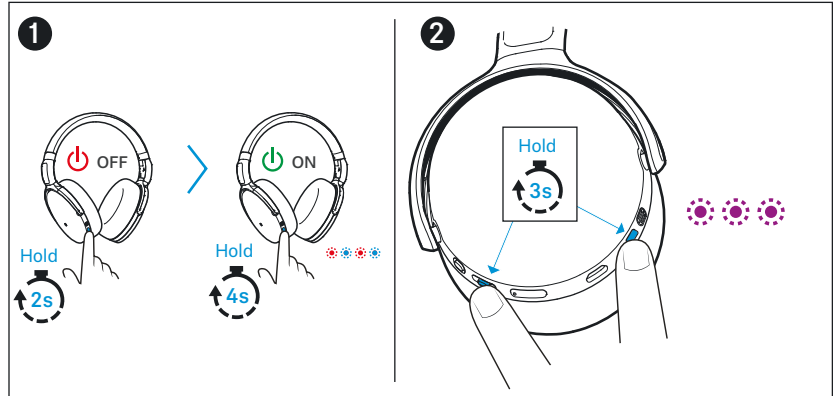

Specifications

Model: SEBT3

Wearing style	Bluetooth® around-ear, closed-back
Ear coupling	circum-aural
Transducer principle	dynamic
Transducer	32 mm
Frequency response	18 Hz to 22,000 Hz (-10 dB)
Sound pressure level (SPL)	108 dB (1 kHz/0 dBFS)
THD (1 kHz, 100 dB SPL)	< 0.3 % (1 kHz, 100 dB SPL)
Microphone principle	MEMS
Microphone frequency response	80 Hz to 6,000 Hz (-3 dB)
Microphone pick-up pattern (speech audio)	dual omni-directional microphones 2-mic beamforming array
Power supply	built-in rechargeable lithium-polymer battery: 3.7 V \approx , 300 mAh USB charging: 5 V \approx , 320 mA max.
Charging time of rechargeable battery	up to 2 hrs
Operating time	30 hrs (music playback via Bluetooth)
Temperature range	<i>operation</i> : 0 °C to +40 °C <i>charging</i> : +10 °C to +40 °C <i>storage</i> : -20 °C to +60 °C
Relative humidity	<i>operation</i> : 10 to 80 %, non condensing <i>storage</i> : 10 to 90 %
Weight (headphones)	approx. 238 g
Magnetic field strength	1.9 mT

Bluetooth

Version	Bluetooth 5.0 compatible, class 1, BLE
Transmission frequency	2,402 MHz to 2,480 MHz
Modulation	GFSK, $\pi/4$ DQPSK, 8DPSK
Output power	12.6 mW (max)
Profiles	HSP, HFP, AVRCP, A2DP
Codec	aptX, aptX LL, AAC, SBC
Device name	HD 350BT LE-HD 350BT (Bluetooth Low Energy only)
Number of active connections	2

Manufacturer Declarations

Warranty

Sennheiser electronic GmbH & Co. KG gives a warranty of 24 months on this product.

For the current warranty conditions, please visit our website at www.sennheiser.com or contact your Sennheiser partner.

In compliance with the following requirements

- General Product Safety Directive (2001/95/EC)
- Compliant to **Sound Pressure Limits** according to country specific requirements

EU declaration of conformity



- RoHS Directive (2011/65/EU)

Hereby, Sennheiser electronic GmbH & Co. KG declares that the radio equipment type SEBT3 is in compliance with the Radio Equipment Directive (2014/53/EU).

The full text of the EU declaration of conformity is available at the following Internet address: www.sennheiser.com/download.

Notes on disposal



- WEEE Directive (2012/19/EU)
- Battery Directive (2006/66/EC & 2013/56/EU)

The symbol of the crossed-out wheeled bin on the product, the battery/rechargeable battery (if applicable) and/or the packaging indicates that these products must not be disposed of with normal household waste, but must be disposed of separately at the end of their operational lifetime. For packaging disposal, please observe the legal regulations on waste segregation applicable in your country.

Further information on the recycling of these products can be obtained from your municipal administration, from the municipal collection points, or from your Sennheiser partner.

The separate collection of waste electrical and electronic equipment, batteries/rechargeable batteries (if applicable) and packaging is used to promote the reuse and recycling and to prevent negative effects caused by e.g. potentially hazardous substances contained in these products. Herewith you make an important contribution to the protection of the environment and public health.

Trademarks

Sennheiser is a trademark of Sennheiser electronic GmbH & Co. KG, registered in the U.S. and other countries.

Apple, the Apple logo and Siri are trademarks of Apple Inc., registered in the U.S. and other countries. App Store is a service mark of Apple Inc. Android and Google play are registered trademarks of Google Inc. The Bluetooth® word mark and logos are registered trademarks owned by Bluetooth SIG, Inc. and any use of such marks by Sennheiser electronic GmbH & Co. KG is under license.

Qualcomm aptX is a product of Qualcomm Technologies International, Ltd. Qualcomm is a trademark of Qualcomm Incorporated, registered in the United States and other countries, used with permission.

Manufacturer Declarations

aptX is a trademark of Qualcomm Technologies International, Ltd., registered in the United States and other countries, used with permission.

Other product and company names mentioned in the user documentation may be the trademarks or registered trademarks of their respective holders.