

XP-5200 Start Here

IMPORTANT: Before using this product, make sure you read these instructions and the safety instructions in the online *User's Guide*.

Note: This printer is designed for use with Epson® cartridges only, not third-party cartridges or ink. For important ink information, visit <http://epson.com/epsonink> (U.S.) or <http://epson.ca/epsonink> (Canada) or see your printer box.

1 Unpack

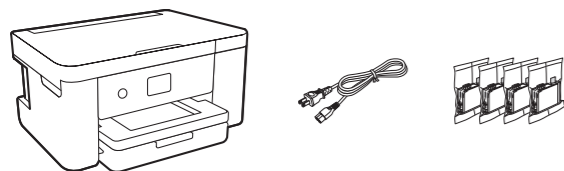

Note: Do not open ink cartridge packages until you are ready to install the ink. Cartridges are vacuum packed to maintain reliability.

- 1 Remove all protective materials from the product and lift up the scanner unit until it locks into place.

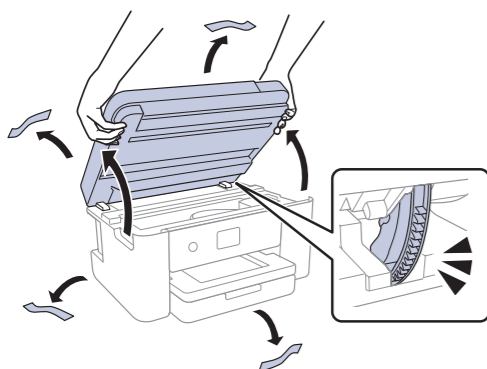

- 2 Remove all protective materials from inside the product.

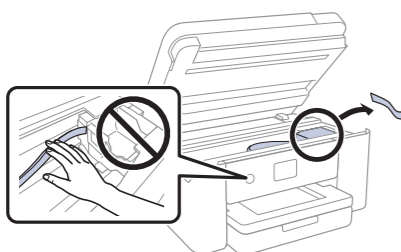

Caution: Do not touch the flat white cable.

- 3 Lower the scanner unit.

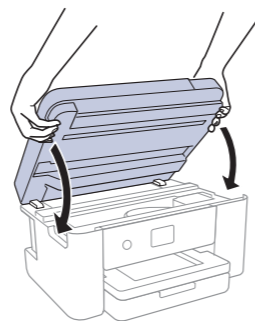

Note: Continue to lower the scanner unit even if you feel some resistance.

- 4 Connect the power cord to the back of the product and to an electrical outlet.

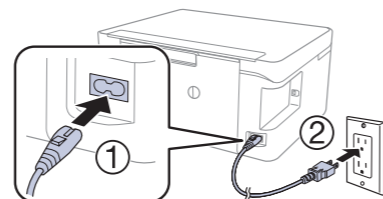

Caution: Do not connect to your computer yet.

2 Choose a setup method

The Epson Smart Panel® app can help you set up your printer through an interactive, step-by-step process using your smartphone or tablet.



OR



To use your mobile device for setup, continue to step 1.

If you do not want to use a mobile device for setup, skip to the "Turn on and configure" section.

- 1 Download the Epson Smart Panel app from your device's app store. Do not launch the app yet.



- 2 Hold the power button until it lights up to turn on the product.

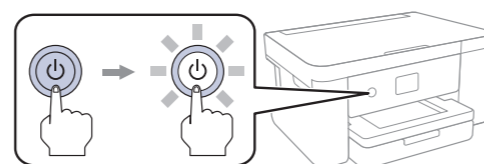

Note: Do not connect your product to your computer yet.

- 3 Launch the app and follow its instructions to set up your product. If necessary, tap the + icon on the top right corner of the app's home screen, tap **Start setting up**, and follow the instructions to set up your product.

For information on connecting your product to a computer, using voice-activated printing, or solving problems, or for details on reaching Epson support, see the sections on the back of this sheet.

3 Turn on and configure

- 1 Raise up the control panel, turn on the product and wait for the power light to turn on.

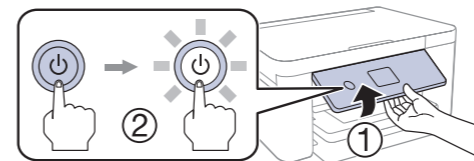

Note: If an error code appears, turn off the product and check that no protective material has been left inside the product.

- 2 Press ▲ or ▼ to select your language, then press OK.

Note: You can change the language later using the product's control panel. For more information, see the online *User's Guide*.

- 3 When you see the Epson Smart Panel setup screen, select **Continue setup without the app** and press OK.

4 Install ink cartridges

Caution: Keep ink cartridges out of the reach of children and do not drink the ink.

Note: The included initial cartridges are designed for reliable printer setup and cannot be used as replacement cartridges or resold. After setup, the remaining ink is available for printing.

- 1 Lift up the scanner unit until it locks into place.

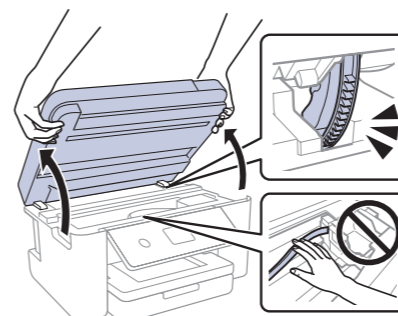

- 2 Gently shake the black ink cartridge.

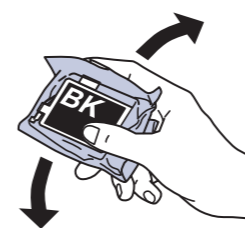

Caution: Do not shake the other ink cartridges.

- 3 Unpack the ink cartridges.

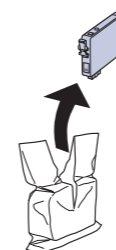

- 4 Remove only the yellow tape from each ink cartridge.

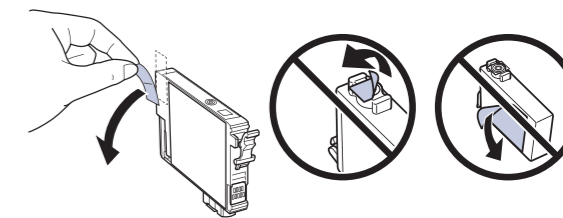

Caution: Do not remove any other labels or seals, or ink will leak. Do not touch the areas shown here.

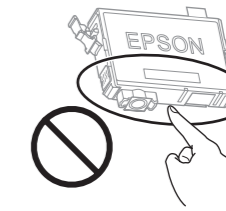

- 5 Insert the cartridge in the holder for each color. Press each cartridge down until it clicks. Make sure all cartridges are pushed down into place.

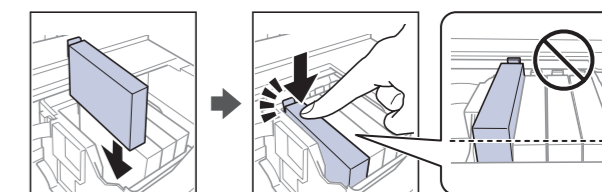

- 6 Lower the scanner unit.

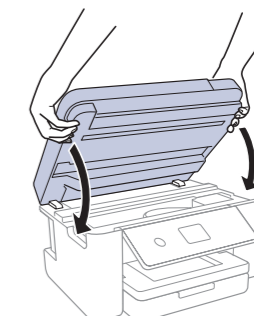

Note: Continue to lower the scanner unit even if you feel some resistance.

- 7 Press OK. The printer starts charging the ink. Ink charging takes approximately 5 minutes. When you see a completion message on the printer's LCD screen, charging is complete.

Caution: Don't turn off the printer or raise the scanner unit while it is charging or you'll waste ink.

Note: As part of setup, your product's serial number will be sent to a secure Epson server so that you can be eligible to participate in programs we may offer from time to time, including the Epson ink replenishment program. You will have a separate opportunity to consent to participating in such programs.

- 8 Follow the on-screen instructions to adjust the print quality of your product.

Note:

- You need to load 4 sheets of letter-size paper before you can adjust the print quality. See "Load paper" on this sheet for details.
- Select **Adjust Later** if you want to adjust the print quality later. For more information, see the online *User's Guide*.



414248800

EPSON
EXCEED YOUR VISION

5 Load paper

See the online *User's Guide* for information about loading capacity, available paper types and sizes, and loading envelopes.

- 1 Make sure the product is done charging the ink, then pull out the paper cassette.

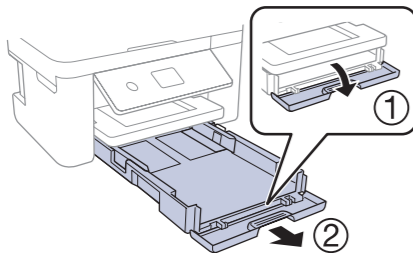

- 2 Squeeze the tab on the right edge guide and slide the side edge guides all the way out.

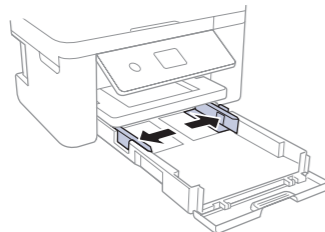

- 3 Insert paper with the glossy or printable side down.

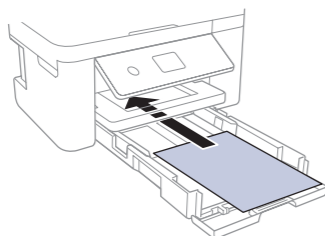

- 4 Slide the edge guides against the paper, but not too tightly.

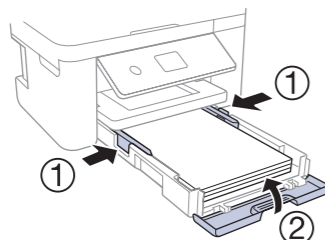

- 5 Keep the cassette flat as you insert it all the way.

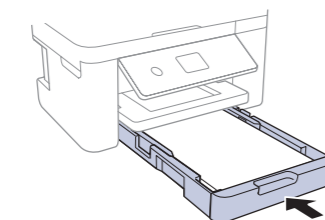

- 6 Pull out the output tray.

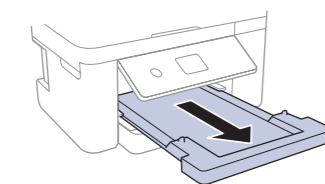

- 7 Follow the instructions on the LCD screen to select your paper settings and adjust the print quality of your product, if necessary.

6 Install software

Note:

- An Internet connection is required to obtain the product software.
- To print from a Chromebook™, go to <http://epson.com/support/chromebookprint> (U.S.) or <http://epson.ca/support/chromebookprint> (Canada) for instructions.

Firmware Update Notice: The printer is designed to work only with genuine Epson-branded cartridges. Other brands of ink cartridges and ink supplies are not compatible and, even if described as compatible, may not function properly or at all. Epson periodically provides firmware updates to address issues of security, performance, minor bug fixes and ensure the printer functions as designed. These updates may affect the functionality of third-party ink. Non-Epson branded or altered Epson cartridges that functioned prior to a firmware update may not continue to function.

- 1 Make sure the product is **NOT CONNECTED** to your computer.

Windows*: If you see a Found New Hardware screen, click **Cancel** and disconnect the USB cable.

- 2 Download and run your product's software package:

<http://epson.com/support/xp5200> (U.S.)
<http://epson.ca/support/xp5200> (Canada)

- 3 Follow the instructions on the computer screen to run the setup program.

- 4 When you see the Select Your Connection screen, select one of the following and follow the on-screen instructions:

• Wireless connection

In most cases, the software installer automatically attempts to set up your wireless connection. If setup is unsuccessful, you may need to enter your network name (SSID) and password.

• Direct USB connection

Make sure you have a USB cable (not included).

Mobile and voice-activated printing

- Print directly from your Android™ (v4.4 or later) device*. Simply connect your printer and device to the same network and tap the menu icon to select the print option.
- Turn your mobile device into an intuitive, easy-to-use printing and scanning control center with Epson Smart Panel. Download the app from your mobile device's app store.
- Print remotely with Epson Connect™. See your online *User's Guide* for instructions or learn more at <http://epson.com/connect> (U.S.) or <http://epson.ca/connect> (Canada).
- Use voice-activated assistants to print a variety of creative and everyday items from your Epson product. Simply add your product to an Epson Connect account, then link the account to a voice-activated assistant. See <http://epson.com/voice> (U.S.) or <http://epson.ca/voice> (Canada) for more information.

* May require the Epson Print Enabler or Mopria Print Service app from Google Play™.

Any problems?

Network setup was unsuccessful.

- Print a network connection report to identify network problems and solutions. See your online *User's Guide* for instructions.
- Make sure you select the right network name (SSID).
- Restart your router (turn it off and then on), then try to connect to it again.
- The printer can only connect to a network that supports 2.4 GHz connections. If your router offers both 2.4 GHz and 5 GHz connections, make sure the 2.4 GHz connection is enabled.
- If you see a firewall alert message, click **Unblock** or **Allow** to let setup continue.
- If your network has security enabled, make sure you enter your network password (WEP key or WPA passphrase) correctly. Be sure to enter your password in the correct case.

There are lines or incorrect colors in my printouts.

Run a nozzle check to see if there are any gaps in the printout. Then clean the print head, if necessary. See the online *User's Guide* for more information.

The product's screen is dark.

Make sure your product is turned on, and press any button to wake it from sleep mode.

Setup is unable to find my printer after connecting it with a USB cable.

Make sure the printer is turned on and the USB cable is securely connected.

Any questions?

User's Guide

Windows: Click the icon on your desktop or Apps screen to access the online *User's Guide*.

Mac: Click the icon in Applications/Epson Software/Guide to access the online *User's Guide*.

If you don't have a User's Guide icon, go to the Epson website, as described below.

Videos

Visit <http://epson.com/support/xp5200videos> (U.S.) or <http://epson.ca/support/xp5200videos> (Canada) to view support videos (videos available only in English).

Technical support

Visit <http://epson.com/support/xp5200> (U.S.) or <http://epson.ca/support/xp5200> (Canada) to download drivers, view manuals, get FAQs, or contact Epson.

Call (562) 276-4382 (U.S.) or (905) 709-3839 (Canada), 7 AM to 4 PM, Pacific Time, Monday through Friday. Days and hours of support are subject to change without notice. Toll or long distance charges may apply.

Recycling

Epson offers a recycling program for end-of-life hardware and ink cartridges. Please go to <http://epson.com/recycle> (U.S.) or <http://epson.ca/recycle> (Canada) for information on how to return your products for proper disposal.

Need paper and ink?

Ensure brilliant results with Epson specialty and plain papers, engineered specifically for Epson printers. Find Epson papers and Epson Genuine Ink at <http://epson.com> (U.S. sales) or <http://epson.ca> (Canadian sales) and at Epson authorized resellers. Call 800-GO-EPSON (800-463-7766).



DESIGNED for
EXCELLENCE™
Epson printers, ink and specialty papers.



XP-5200 replacement ink cartridges

Color	Standard-capacity	High-capacity
Black	222120	222XL120
Cyan	222220	—
Magenta	222320	—
Yellow	222420	—



EPSON, Epson Smart Panel, and Claria are registered trademarks, EPSON Exceed Your Vision is a registered logomark, and Epson Connect is a trademark of Seiko Epson Corporation.

Designed for Excellence is a trademark of Epson America, Inc.

Windows is a registered trademark of Microsoft Corporation in the United States and/or other countries.

Mac is a trademark of Apple Inc., registered in the U.S. and other countries.

Android, Chromebook, and Google Play are trademarks of Google LLC.

General Notice: Other product names used herein are for identification purposes only and may be trademarks of their respective owners. Epson disclaims any and all rights in those marks.

This information is subject to change without notice.

© 2022 Epson America, Inc., 1/22

Printed in XXXXX

CPD-61856