

Please read the **Product Safety Guide** first, then read this guide for the correct installation procedure. Save this guide after setup for your reference.

! WARNING	WARNING indicates a potentially hazardous situation which, if not avoided, could result in death or serious injuries.
------------------	--

1 Unpack the scanner and check the components

The components included in the box may differ depending on your country. Remove the protective tape and film covering the scanner.

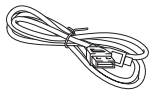
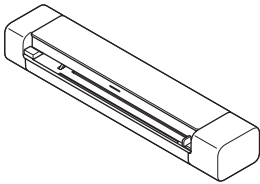

Micro USB 3.0 Cable

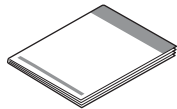

Quick Setup Guide/Product Safety Guide

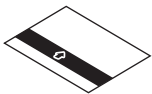

Calibration Sheet

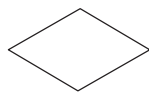

Warranty Card

! WARNING

This product is packaged in a plastic bag. To avoid suffocation, keep plastic bags away from babies and children. The bag is not a toy.

NOTE

- We recommend saving the original packaging in case you must ship your scanner.
- To establish a local connection to a computer, use the supplied micro USB 3.0 cable.

Secure Network Access

Your machine's default password is on the label on the bottom of the scanner (preceded by "Pwd"). We strongly recommend you change it to protect your machine from unauthorised access.

2 Connect your scanner to the computer

DSmobile DS-640/DS-740D

Connect your scanner to the computer using the supplied USB cable.

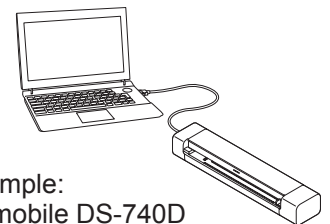

Example:
DSmobile DS-740D

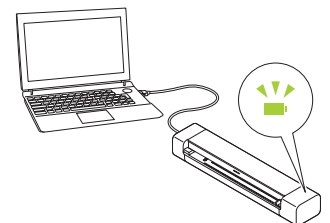

DSmobile DS-940DW

1. Connect your scanner to the computer using the supplied USB cable.
2. Wait until the scanner's built-in battery is fully charged (the Battery LED blinks in green) before you use the scanner.
3. Press to turn the scanner on.

3 Insert the microSD memory card into the scanner (optional) (DSmobile DS-940DW only)

If you plan to save files to a microSD memory card (purchased separately), gently insert the card into your scanner's memory card slot with the printed side facing downwards.

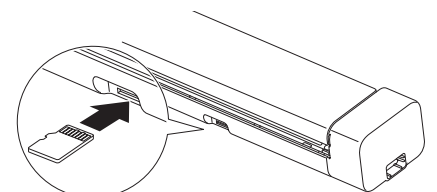

4 Install software

A Using your scanner with your computer

NOTE

Make sure that you are logged on with Administrator rights.

Mac and Windows computers



Download the full driver and software package.

For Windows: support.brother.com/windows

For Mac: support.brother.com/mac

Double-click the downloaded file to begin the installation, and then follow the on-screen instructions.



When finished, restart your computer.

To scan using your computer, install the software supplied with your scanner. For more information, see the *Online User's Guide*.



Finish

B Using your scanner with your mobile device (DSmobile DS-940DW only)



Download and install our free mobile app **Brother iPrint&Scan** from the App Store or Google Play™.



Slide the Mode Select Switch to

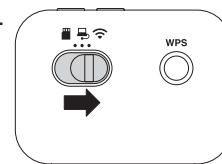

Activate the Wi-Fi function of your mobile device so that it can find your scanner.



On your device, select your scanner's SSID (Network Name): **DIRECT-xxDS-940DW_BRxxxx**.



When prompted, enter the Password (Network Key). (The SSID and Password can be found on the label on the bottom of the scanner (preceded by "PASS")).



Finish

Confirm the scan mode before scanning (DSmobile DS-940DW only)

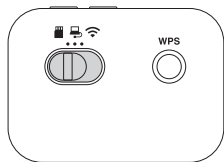

microSD Mode : Sends the scanned data to a microSD memory card
USB Mode : Sends the scanned data to a computer using a USB cable
Wi-Fi Mode : Sends the scanned data to a wireless computer/mobile device

LED Indications

For more information about troubleshooting your scanner, see the *Online User's Guide*.

DSmobile DS-640/DS-740D



- Cover is open
- Paper jam

Blinks in orange

DSmobile DS-940DW

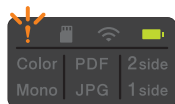

- Cover is open
- Paper jam
- Connection error

Blinks in orange



Memory card not inserted when the scanner is in microSD mode

Blinks in white



Wi-Fi connection error when the scanner is in Wi-Fi mode

Blinks in orange
 Blinks in blue

NOTE

Brother SupportCenter is a mobile app that provides the latest support information for your Brother product. Visit the App Store or Google Play™ to download and install it on your mobile device.

Symbols and conventions used in this guide

The following symbols and conventions are used throughout this guide:

DANGER

DANGER indicates an imminently hazardous situation which, if the product is handled without following the warnings and instructions, will result in death or serious injuries.

WARNING

WARNING indicates a potentially hazardous situation which, if not avoided, could result in death or serious injuries.

CAUTION





CAUTION indicates a potentially hazardous situation which, if not avoided, may result in minor or moderate injuries.

IMPORTANT

IMPORTANT indicates a potentially hazardous situation which, if not avoided, may result in damage to property or loss of product functionality.

NOTE

NOTE tells you how you should respond to a situation that may arise or give tips about other scanning features.

-  Prohibition icons indicate actions that must not be performed.
-  This icon indicates that flammable sprays may not be used.
-  This icon indicates that organic solvents, such as alcohol or other liquids, may not be used.
-  Electrical Hazard icons alert you to possible electrical shocks.
-  Fire Hazard icons alert you to the possibility of fire.

Follow all warnings and instructions marked on the scanner.

Compilation and Publication Notice

This manual has been compiled and published to provide the latest product safety information at the time of publication. The information contained in this manual may be subject to change.

For the latest manual, please visit us at support.brother.com/manuals

Choose a safe location for the scanner

Put the scanner on a flat, stable surface that is free from shocks and vibrations, such as a desk. Choose a dry, well-ventilated location where the temperature remains between 5°C and 35°C and the humidity is between 20% to 80% (without condensation).

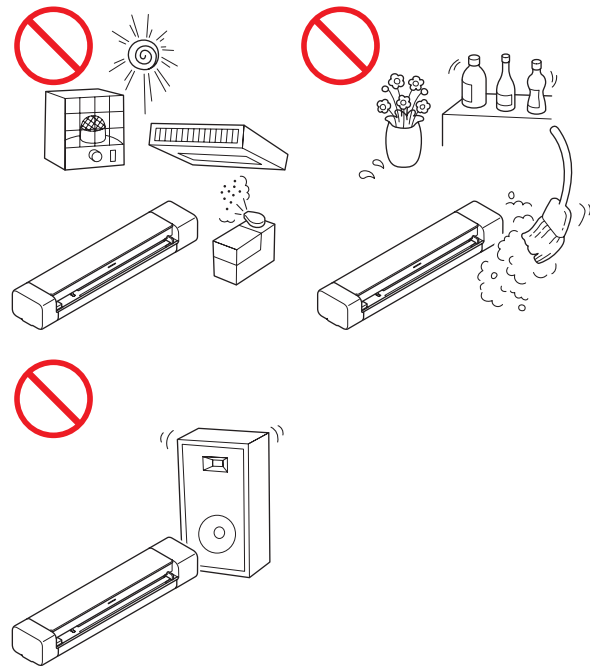

Product Safety Guide

DANGER



(DSmobile DS-940DW only)
Use the rechargeable Li-ion battery only for its intended purpose.



(DSmobile DS-940DW only)
To charge the rechargeable Li-ion battery, connect your scanner with your computer using the supplied Micro USB cable.



(DSmobile DS-940DW only)
DO NOT charge the rechargeable Li-ion battery near a fire or in direct sunlight. This could activate the protection circuitry, which is designed to prevent danger from high heat. Activation of the protection circuitry could cause charging to stop, charging to occur with excessive current or voltage if the protection circuitry fails, or an abnormal chemical reaction within the battery.



(DSmobile DS-940DW only)
DO NOT connect the + and - terminals with metal objects such as wire. Do not carry or store the rechargeable Li-ion battery with metal objects.



(DSmobile DS-940DW only)
Keep the rechargeable Li-ion battery away from heat and fire.



(DSmobile DS-940DW only)
DO NOT use or leave a scanner with the rechargeable Li-ion battery installed near fire, heaters, or other high-temperature (above 60°C) locations.



(DSmobile DS-940DW only)
DO NOT allow the rechargeable Li-ion battery to come into contact with liquids.



DO NOT use in corrosive environments, such as areas where salty air, salt water, acids, alkalis, corrosive gases, chemicals, or any corrosive liquid is present.



(DSmobile DS-940DW only)
DO NOT use the rechargeable Li-ion battery if it is damaged or leaking.



(DSmobile DS-940DW only)
DO NOT solder any connections to the rechargeable Li-ion battery.



(DSmobile DS-940DW only)
DO NOT directly connect the rechargeable Li-ion battery to a household electrical supply.



(DSmobile DS-940DW only)
Liquid (electrolyte) leaking from the scanner or rechargeable Li-ion battery may indicate that the rechargeable Li-ion battery is damaged. If the rechargeable Li-ion battery leaks, immediately discontinue use of the scanner, unplug the cable, and isolate the scanner by putting it in a bag. Do not touch the electrolyte. If liquid from the rechargeable Li-ion battery gets into your eyes, wash them immediately with clean water. Contact emergency services immediately. If left alone, the electrolyte could cause eye damage. If electrolyte contacts your skin or clothing, immediately rinse them with water.



(DSmobile DS-940DW only)
DO NOT put the rechargeable Li-ion battery, or a scanner with the rechargeable Li-ion battery installed, into a microwave oven or a high pressure container.



(DSmobile DS-940DW only)
If the scanner can only be used for a short period of time, even though the rechargeable Li-ion battery is fully charged, the rechargeable Li-ion battery may have reached the end of its service life. When removing the rechargeable Li-ion battery, cover the terminals of the old rechargeable Li-ion battery with tape to avoid creating a short in the battery.



(DSmobile DS-940DW only)
DO NOT disassemble or modify the rechargeable Li-ion battery.

Product Safety Guide



(DSmobile DS-940DW only)
DO NOT intentionally overheat the rechargeable Li-ion battery or dispose of it in fire. Doing so could cause the insulation to melt, gas to be emitted, or the safety mechanism to fail. The electrolyte solution could also catch fire, resulting in overheating, smoke, an explosion, or fire.



(DSmobile DS-940DW only)
DO NOT puncture the rechargeable Li-ion battery with any objects, subject it to severe shocks or throw it. Damage to the rechargeable Li-ion battery's protection circuit could cause the rechargeable Li-ion battery to be recharged at an abnormal current/voltage or cause an abnormal chemical reaction within the rechargeable Li-ion battery.



(DSmobile DS-940DW only)
DO NOT incinerate the rechargeable Li-ion battery or dispose of it with household waste.

WARNING



(DSmobile DS-940DW only)
Keep the rechargeable Li-ion battery away from infants. If ingested, contact emergency services immediately.



Keep the USB cable out of the reach of children to avoid injury.



DO NOT disassemble or modify the scanner, otherwise a fire or electric shock may occur. If the scanner requires repair, contact your Brother dealer or Brother customer service.



(DSmobile DS-940DW only)
Stop using the rechargeable Li-ion battery if there are noticeable abnormalities such as smell, heat, deformities, or discolouration. Turn the power switch off immediately and remove the USB cable from the power source.



Never insert any objects into the slots in the scanner's casing, since they may touch dangerous voltage points or short out parts resulting in the risk of fire or electrical shock. If metal objects, water or other liquids get inside the scanner, immediately unplug the scanner from the power source. Contact your Brother dealer or Brother customer service.



DO NOT place the scanner near radiators, heaters, air conditioners, water, chemicals or devices that contain magnets or generate magnetic fields. Doing so may create the risk of a short circuit or fire should water come into contact with the scanner (including condensation from heating, air conditioning, and/or ventilation equipment that may be sufficient to create a short circuit or fire).



DO NOT place the scanner near chemicals or in a place where chemical spillage could occur. In particular, organic solvents or liquids may cause the casing and/or cables to melt or dissolve, risking a fire or electrical shock. They may also cause the scanner to malfunction or become discoloured.



Plastic bags are used in the packaging of the scanner. To avoid danger of suffocation, keep them away from babies and children. Plastic bags are not toys.



DO NOT expose the scanner to direct sunlight, excessive heat, open flames, corrosive gasses, moisture or dust. DO NOT place the scanner on a carpet or rug, as this will expose it to dust. Doing so may create a risk of an electrical short or fire. It may also damage the scanner and/or render it inoperable.



DO NOT use flammable substances, any type of spray, or an organic solvent/liquid that contains alcohol or ammonia to clean the inside or outside of the scanner. Doing this may cause a fire or electrical shock.

CAUTION



Avoid placing the scanner in a high-traffic area. If you must place it in a high-traffic area, ensure that the scanner is in a safe location where it cannot be accidentally knocked over, which could cause injury to you or others and serious damage to the scanner.



Ensure that cables and cords leading to the scanner are secured so as not to pose a tripping hazard.



Make sure that no part of the scanner protrudes from the desk or stand where the scanner is located. Make sure that the scanner is located on a flat, level, and stable surface free from vibration. Failure to observe these precautions could cause the scanner to fall, causing an injury.



DO NOT place the scanner on an unstable or tilted cart, stand, or table, or on any tilted/slanted surface. The scanner may fall, causing injury to you and serious damage to the scanner. There is an added risk of injury if the scanner glass should break.



Do not place heavy objects on the scanner. It may cause unbalance and the scanner may fall down. This may result in injury.

IMPORTANT

Do not use the scanner in locations where temperature changes are extreme. The resulting condensation may result in scanner failure or malfunction. If condensation forms, wait until it dries completely before using the scanner again.

Servicing the scanner

DO NOT attempt to service the scanner yourself. Opening or removing covers may expose you to dangerous voltages and other risks, and may void your warranty. Contact your Brother dealer or Brother customer service.

WARNING



If the scanner has been dropped or the casing has been damaged, there may be the possibility of an electrical shock or fire. Unplug the scanner from the power source and contact your Brother dealer or Brother customer service.



If the scanner becomes unusually hot, releases smoke, generates any strong smells, or if you accidentally spill any liquid on it, immediately unplug the scanner from the power source. Contact your Brother dealer or Brother customer service.

IMPORTANT

If the scanner does not operate normally when the operating instructions are followed, adjust only those controls that are covered by the operating instructions. Incorrect adjustment of other controls may result in damage, and will often require extensive work by a qualified technician to restore the scanner to normal operation.

Rechargeable Li-ion battery (DSmobile DS-940DW only)

- At the time of purchase, the rechargeable Li-ion battery is slightly charged so that the operation of the scanner can be verified; however, the rechargeable Li-ion battery should be fully charged via the USB port before the scanner is used.
- If the scanner will not be used for a long period of time, store it in a location where it is not exposed to high humidity or high temperatures (temperatures between 15°C and 25°C and the humidity between 40% and 60% are recommended). In order to maintain the efficiency and life of the rechargeable Li-ion battery, charge it at least every three months.
- If you notice anything unusual about the rechargeable Li-ion battery the first time it is used, for example overheating or rust, DO NOT continue to use the battery. Contact your Brother dealer or Brother customer service.

Tips on using the rechargeable Li-ion battery (DSmobile DS-940DW only)

- Charge the rechargeable Li-ion battery before use. Do not use the scanner until the rechargeable Li-ion battery has been fully charged.
- The rechargeable Li-ion battery charging can take place in 5°C - 39°C environments. If the surrounding temperature is out of this range, the rechargeable Li-ion battery will not be charged, and the battery indicator will remain lit.
- If the scanner is used when both the rechargeable Li-ion battery is installed and the scanner is connected to your computer, charging may stop even if the rechargeable Li-ion battery has not been fully charged.

Rechargeable Li-ion battery characteristics (DSmobile DS-940DW only)

Understanding the properties of the rechargeable Li-ion battery will allow you to optimise its usage.

- Using or storing the rechargeable Li-ion battery in a location exposed to high or low temperatures may accelerate its deterioration. In particular, using a rechargeable Li-ion battery with a high charge (90% or more) in a location exposed to high temperatures will considerably accelerate battery deterioration.
- Using the scanner while the rechargeable Li-ion battery is installed and charging may accelerate the battery's deterioration.
- If the rechargeable Li-ion battery will not be used for a long period of time, we recommend charging it every three months.
- While the rechargeable Li-ion battery is charging, the scanner may become warm. This is normal, and the scanner may be used safely. If the scanner becomes extremely hot, stop using it.

Surroundings temperature range

Charge		0°C - 45°C
Standard discharge current 0.24 A		-10°C - 60°C
Maximum discharge current 1.2 A		0°C - 60°C
Battery (Installed)	Less than 1 month	-20°C - 45°C
	Less than 3 months	-20°C - 35°C
	Less than 1 year	-20°C - 25°C

Charging parameters

Maximum charging voltage	4.35 Vdc
Maximum charging current	1200 mA

How to remove the rechargeable Li-ion battery (DSmobile DS-940DW only)

NOTE

We do not recommend removing the rechargeable Li-ion battery unless disposing of the scanner.

Turn the scanner off and remove the USB cable from the scanner before removing the rechargeable Li-ion battery.

1. Place the scanner face down and remove the Side Cover using a flathead screwdriver.
2. Disconnect the rechargeable Li-ion battery connector from the Printed Circuit Board Assembly (PCBA). Do not disconnect the Flexible Flat Cable (FFC).
3. Push the release tab (as illustrated) to remove the rechargeable Li-ion battery from the Side Cover.
4. Cover the rechargeable Li-ion battery terminals with tape and dispose of the battery according to the applicable local regulations.

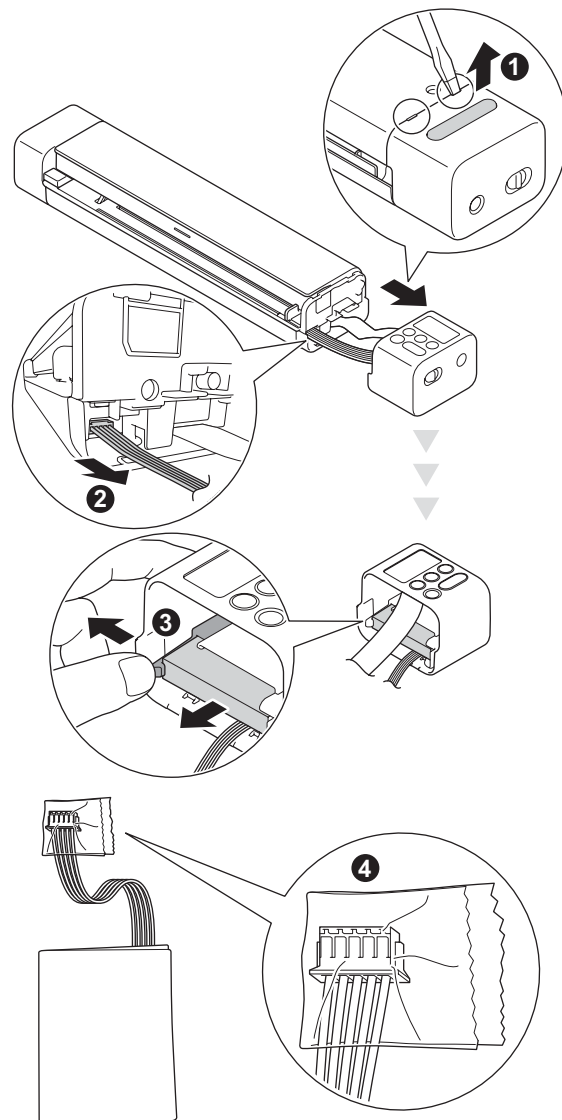

NOTE

For more information about handling the rechargeable Li-ion battery, see the applicable instructions and warnings in this guide.

Product Warranty & Liability

Nothing in this guide shall affect any existing product warranty or be construed as granting any additional product warranty. Failure to follow the safety instructions in this guide may invalidate your product's warranty.

Declaration of Conformity (Europe only)

We, Brother Industries, Ltd.
15-1 Naeshiro-cho, Mizuho-ku, Nagoya 467-8561 Japan declare that these products are in conformity with the relevant EU harmonization legislation (Europe only) and UK legislation (Great Britain only). The Declaration of Conformity (DoC) can be downloaded from our website. Visit support.brother.com/manuals.

UK Declaration of Conformity for Radio Equipment Regulation 2017 (Great Britain only) (DSmobile DS-940DW only)

We, Brother Industries, Ltd.
15-1 Naeshiro-cho, Mizuho-ku, Nagoya 467-8561 Japan declare that these products are in conformity with the provisions of the Radio Equipment Regulation 2017. A copy of the Declaration of Conformity can be downloaded by following the instructions in the Declaration of Conformity (Europe only) section.

EU Declaration of Conformity for RE Directive 2014/53/EU (Europe only) (DSmobile DS-940DW only)

We, Brother Industries, Ltd.
15-1 Naeshiro-cho, Mizuho-ku, Nagoya 467-8561 Japan declare that these products are in conformity with the provisions of the RE Directive 2014/53/EU. A copy of the Declaration of Conformity can be downloaded by following the instructions in the Declaration of Conformity (Europe only) section.



Wireless LAN (DSmobile DS-940DW only)

This scanner supports a wireless interface.

Frequency band(s): 2400 - 2483.5 MHz Maximum radio-frequency power transmitted in the frequency band(s): less than 20 dBm (E.I.R.P)

WLAN Enable/Disable (DSmobile DS-940DW only)

To turn the wireless network connection on, slide the Mode Select Switch to .

To turn the wireless network connection off, slide the Mode Select Switch to  or .

Recycling information in accordance with the WEEE and Battery Directives



Product mark



Battery mark

Europe only

The product/battery is marked with one of the above recycling symbols. It indicates that at the end of the life of the product/battery, you should dispose of it separately at an appropriate collection point and not place it in the normal domestic waste stream. (DSmobile DS-940DW only)

For more information about removing the rechargeable Li-ion battery, see *How to remove the rechargeable Li-ion battery* in this guide.

Chemical Substances (EU REACH)

Information concerning chemical substances within our products required for the REACH Regulation can be found at <https://www.brother.eu/reach>.

Trademarks

BROTHER is either a trademark or a registered trademark of Brother Industries, Ltd.

Android and Google Play are trademarks of Google LLC.

Apple, App Store and Mac are trademarks of Apple Inc., registered in the U.S. and other countries.

Wi-Fi is a registered trademark of Wi-Fi Alliance®.

microSD Logo is a trademark of SD-3C LLC.

Each company whose software title is mentioned in this manual has a Software License Agreement specific to its proprietary programs.

Any trade names and product names of companies appearing on Brother products, related documents and any other materials are all trademarks or registered trademarks of those respective companies.

Compilation and Publication

Under the supervision of Brother Industries, Ltd., this manual has been compiled and published, covering the latest product descriptions and specifications.

The contents of this manual and the specifications of this product are subject to change without notice.

Brother reserves the right to make changes without notice in the specifications and materials contained herein and shall not be responsible for any damages (including consequential) caused by reliance on the materials presented, including but not limited to typographical and other errors relating to the publication.

Copyright and License

© 2019 Brother Industries, Ltd. All rights reserved.

Open Source Licensing Remarks

This product includes open-source software. Please visit support.brother.com to see the open source licensing remarks.

Brother customer service

Customer service

Visit www.brother.com for contact information for your local Brother office.

Service centre locations

For service centres in Europe, contact your local Brother office. Address and telephone contact information for European offices can be found at www.brother.com by selecting your country.

Unlawful use of scanning equipment

It is an offence to make reproductions of certain items or documents with the intent to commit fraud. The following is a non-exhaustive list of documents which it may be unlawful to produce copies of. We suggest you check with your legal adviser and/or the relevant legal authorities if in doubt about a particular item or document:

- Currency
- Bonds or other certificates of debt
- Certificates of deposit
- Armed forces service or draft papers
- Passports
- Postage stamps (cancelled or uncanceled)
- Immigration papers
- Welfare documents
- Cheques or drafts drawn by governmental agencies
- Identifying badges or insignias

Copyrighted works cannot be copied lawfully, subject to the "fair dealing" exception relating to sections of a copyrighted work. Multiple copies would indicate improper use. Works of art should be considered the equivalent of copyrighted works.

brother



www.brotherearth.com