



T1

User manual

EN

Accessories

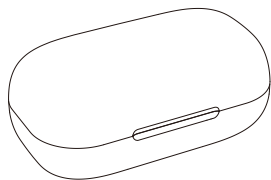

charging case



Eartips



T1 Earbuds

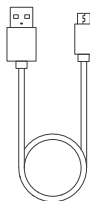

Charging cable



Quick start guide

T1 Overview

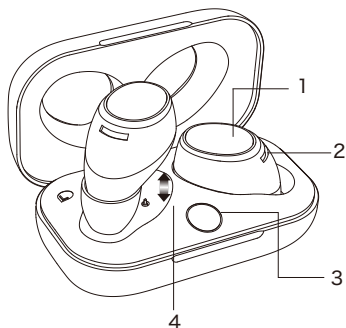

1	Music & Call Button
2	Microphones
3	Light
4	Charging Pocket

Power on/off

Power on when pick out from the charging case. Power off and charge when place back in the case.

Pair with Bluetooth

Earbuds remove from the case, after automatically turn on, the right will automatically connect to the left. After the right connect to the left, Left with "pairing" prompt tone, the LED indicator flashes green and blue;

Note: You have 3 mins to paired with your device, or they out pairing mode. Put them in the case to wake them back up.

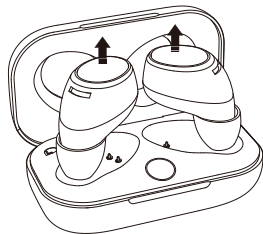

Turn on the Bluetooth on your device, go to Bluetooth menu, select for: T1, pair and connect. You will hear "Connected" when pairing is complete.

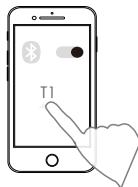

Note:

Left earbud will connect to your device. The right one will connect to the left.

Best fit & best sound

Try all the ear tips to find the best fit and the best sound. The fit is right when you get a complete seal, the ear tips feel comfortable, and you get the best quality and loudest sound.

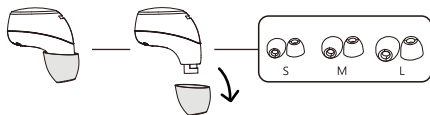

Insert the earbuds with the ear tip directed towards your ear canal. Twist gently until fit comfortably and feel secure in your ear. It will be affect the signal of the earphone and microphone if wrong wearing.

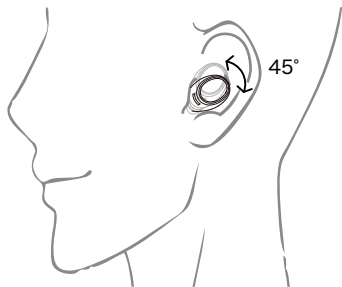

Wrong wearing

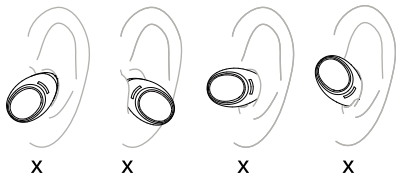

Tip: More than one ear tips size may fit you. Choose the one that completely seals your ear canal for the best sound. You may need different size ear tips for left and right.

Music

Start playing music on your music player and you could control it with both master and partner earbud.



Music Control
Button(Play/
Pause)

- ※ Press once to pause a track. Press again to resume.
- ※ Double-press to go to the next track.
- ※ Triple-press to go back one track

Calls

When making and answering calls, you can press master earbud.



Call Control
Button(Answer/
Rejected)

- ※ Press once to answer an incoming call, or press and hold MFB for 2 seconds to reject it.
- ※ Press once to end a call.
- ※ When you are talking on the phone and receive another incoming call,

1. Press MFB once time, end first call and answer new coming call;
2. Long press MFB 2 seconds, answer new call and first call will be placed on hold;
3. if new coming call answer and first call on hold, long press MFB 2 seconds, switching between two calls.

Note: All calls will be heard in the left earbud only.

Charge the earbuds

Put the earbuds into the case.

The earbud green light turns on when it is charging and light turns off when it is completely charged.

Charge the case

Charging the case by plugging in the charging cable. The case breathing blue light when it is charging

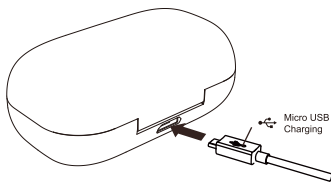

Charge level

Your earbuds let you know when your battery level is low. Every 20 seconds you will hear "Battery low" when there is 5 minutes of battery level.

Earbud status lights

Charging	Steady green light(Case with breathing blue light)
Full charge	Light turn off (Case turn off breathing light)
Pairing	Blinking blue and green

Case status lights

When your case is plugged into a charge cable for charging , you will see charging lights.

Charging	Breathing blue light
Full charge	Steady blue light (Light turn off after pull out charging cable)
Battery low	Blinking blue

Note: Your battery is designed to last life of the product. It should only be removed by a recycling facility. And attempt to remove or replace your battery will damage the product and void your warranty.

Pairing Left & Right earphone Guide:

1. Put both earphone back to the charging case. then Pick out the both earphone from the charging capsule;
2. Make sure both of earphone didn't connected with any devices;
3. Double click the main button of left earphone you'll hear "Pairing" from the left earphone. Then Hold the main button of left earphone for 3 seconds, You'll hear "TWS searching". While the indicator light was flashing blue and green;
4. Double click the MFB button of right earphone, you'll hear " pairing"
5. Wait until you hear "TWS Connected" from right earphone, Pairing done.

Basic Specifications of Earphone

Size: 23.6x16.5x26.7mm
Weight: 4.5g
Earbuds Charging Current:55mA
Earbuds Charging time: 1 hour
Working Voltage: 3.3V~4.2V
Standby time: about 40 hours
Music Time:2~2.5 hours
Talking Time:2 hours
Bluetooth version: Bluetooth 4.2
Support Profile: HSP, HFP, A2DP, AVRCP
RF transmit: Class-2
Transmission Range (Hz): 2.40GHz ~ 2.48GHz
Transmission distance: 10m
Audio sampling accuracy: 16bits
Audio sampling rate: 44.1~48kHz
Audio encoding format: CVSD,MSBC,SBC, AAC
SNR: >95dB
Working temperature: -15°C~+60°C
Working humidity: 10%~85%(in a non-frozen state)

Earbud Speaker Specifications

Speaker specifications / mode: Φ 6mm
Impedance: 16 Ω / TYP.
Frequency(Hz): 20Hz~20KHz
Sensitivity: 93 \pm 3dB
Input Power: 2.0mW (Normal), 5mW (Maximum)

Earbud MIC Specifications

1. MIC type: Silicon MIC
2. MIC sensitivity: -42 \pm 3dB
3. SPL : 130dB

Basic Specifications of Charging Case

Size: 59.5*34.5*27.3mm Weight:27.6g
Charging Port: Micro
Charging base(Full) provide power to earphone: 1.5 times
Charging time : 1-2hrs
Input Voltage :DC5V
Charging current:300mA
Output Voltage:DC5V

Safety instructions for use

To avoid hearing damage, keep the volume at a moderate level. Avoid listening to music at loud volume levels for prolonged periods of time as this may cause permanent hearing damage or hearing loss. Do not use T1 when it is unsafe to do so. For example, while operating a vehicle, cycling, crossing a road, or any activity which requires your attention and ability to hear.

Note: If you are watching video while using your earbuds, your audio may be slightly out of sync with your device.



Safety Warning

Please disconnect the USB cable after charging. Product should not be charging in a long time. Please use the charger or adaptor with output voltage and current(max) 5V/1A or 5V/1.5A and product original charging cable for the product charging. If the output voltage and current of the charger exceeds the requirement, it will cause severe damage to the product, and the product warranty will be invalid.