

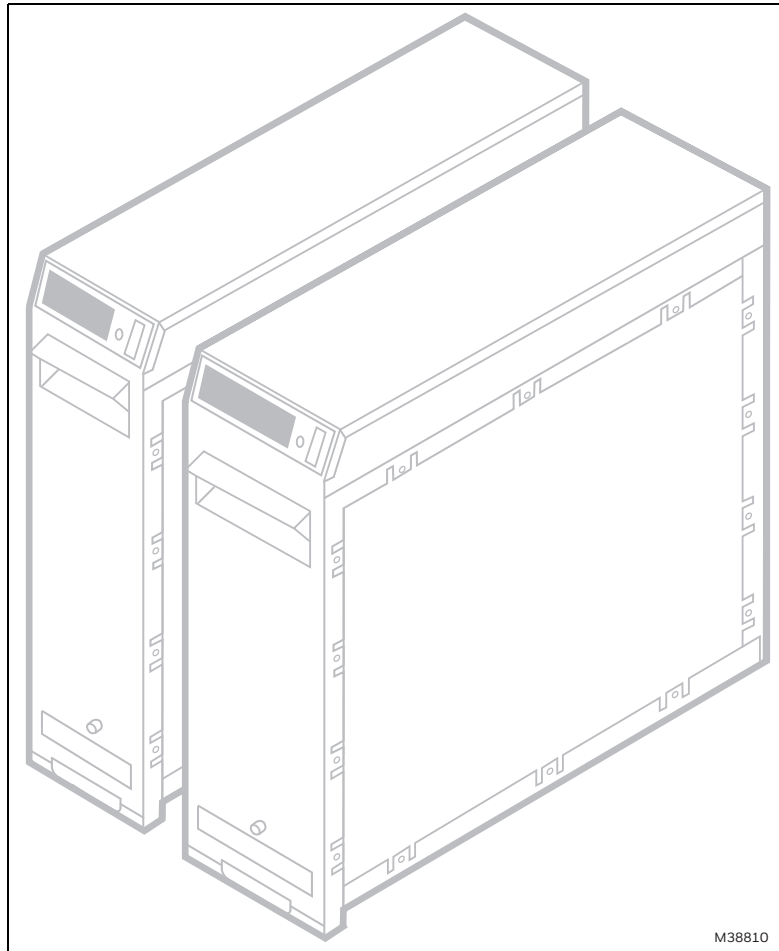

F50F and F300E Electronic Air Cleaners

OWNER'S GUIDE



M38810

CONTENTS

Operating Your Electronic Air Cleaner	2
Getting the Most From Your Electronic Air Cleaner	2
Cleaning Prefilter(s), Cell(s) and Postfilter(s)	3
How Electronic Air Cleaning Works	5
Before You Call for Service	6
Resideo 10 Year Ultraclean Coil Guarantee™	6
Limited Five-year Warranty	7
Product Registration	8



OPERATING YOUR ELECTRONIC AIR CLEANER

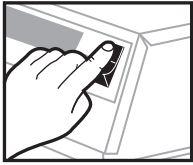

Turn the On-Off switch on the power box to On.

NOTE: Set the switch to 1 for On and set the switch to 0 for Off.

The air cleaner now operates whenever your furnace/air conditioning system fan operates. For maximum air cleaning benefit and cleaner air conditioner coils, leave the air cleaner switch turned on at all times and the thermostat fan switch set to On. Of course, continuous fan operation adds to your electric bill each month. Check your equipment for the amount of electricity needed to run your System fan.

When the fan and air cleaner come on, the neon indicator lights.

You may hear a snapping (electrical arcing) sound occasionally as the air cleaner operates. This is usually caused by a larger dust particle that causes a high voltage discharge. The snapping sound means that your air cleaner is working as it should. To hear the snapping sound, momentarily press the test button near the bottom of the door. Use the test button any time you want to prove air cleaner operation.

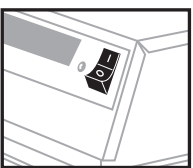

The switch remains in the On position to keep the air cleaner running.

When the fan and air cleaner stops, the neon light goes off. The air cleaner is off until the heating or air conditioning and fan start again.

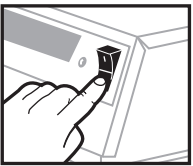

If you do not want the air cleaner to run, set the On-Off switch to Off to turn off the air cleaner. Your furnace and air conditioner continue to operate normally, but without the added benefit of air cleaning. Normally, this switch should be turned to On at all times.

GETTING THE MOST FROM YOUR ELECTRONIC AIR CLEANER

Run the electronic air cleaner as much as possible

For greatest efficiency, the air cleaner should run all the time. To do this, set the Fan switch on your thermostat to On, and make sure the air cleaner is turned on. The fan and air cleaner run even when the furnace or air conditioner is off.

NOTE: A manual fan switch may be built into the furnace or furnace fan controller.

The air cleaner uses less power than a 40 watt light bulb (two-cell model—33 watts; single cell model—22 watts). Many believe that the added cost is more than offset by the added benefits of full-time air cleaning and full-time air circulation. And you may feel that the room temperature stays more even when the fan is always on.

Even if your thermostat does not have a Fan On position, you can obtain maximum available air cleaning benefit by making sure the air cleaner is always turned to On so it operates whenever the furnace or air conditioner is on.

Keep the cell(s) and prefilter(s) clean

Although the air cleaner is designed to be efficient over a wide range of cell dirt loading conditions, regular cleaning is your best assurance of consistent performance. Also, a very dirty prefilter and cell reduces air flow and, in turn, this reduces the efficiency of the furnace or air conditioner.

Replace postfilter regularly

A high-efficiency postfilter is sometimes installed in the air cleaner. This filter increases the efficiency of the air cleaner and should be changed every six months of usage.

If you have a humidifier

All Resideo whole house humidifiers can be used in a system with the Resideo Electronic Air Cleaner without any additional filters or system modification.

If your system includes an atomizing humidifier, you may want to install a standard furnace filter between the humidifier and the air cleaner. This filter would keep the humidifier spray mineral deposits from collecting on the air cleaner. This filter should be checked regularly and changed when it shows signs of mineral or dirt buildup. If you do not install a filter, you will probably need to wash the cell(s) and prefilter(s) more often to remove the mineral buildup.

If an ultrasonic room humidifier is used often, especially if filled with tap (undistilled) water, the cell(s) and prefilter(s) require more frequent washing. A white residue accumulates on the cell(s) from the minerals in the water. This residue may also contribute to "white dust." See About lint or "white dust" section for more information.

CLEANING PREFILTER(S), CELL(S) AND POSTFILTER(S)

CAUTION

**Sharp edges.
Can cause personal injury.**
Carefully handle cell(s) or wear protective gloves to avoid cuts from sharp metal edges.

Setting a regular cleaning schedule

To ensure optimum performance from the air cleaner, the prefilter(s) and cell(s) must be cleaned regularly— twice a year with normal use or more frequently with heavy use. Use the wash reminder schedule below to help establish and maintain a regular cleaning schedule. Mount the wash reminder schedule in a convenient location.

ELECTRONIC AIR CLEANER WASH REMINDER SCHEDULE

INSTALLATION DATE: _____

YEAR	J	F	M	A	M	J	J	A	S	O	N	D

NOTE: You may let the heating or air conditioning system operate normally while the cell(s) are being washed. Simply turn off the air cleaner switch.

Cleaning your Prefilter

1. The quickest and easiest way to clean your prefilter is to use the brush attachment of your vacuum cleaner to vacuum the lint off the dirty side of the prefilter. Greasy dirt may require soaking the prefilter in a tub or rinsing with the garden hose. Do not wash the prefilter in the dishwasher or car wash.
2. The prefilter should be cleaned every 6 months or more frequently with heavy use. This will keep the prefilter clean of air choking lint that can make your system work harder.

Vacuum the prefilter with a brush attachment, rinse it with a hose, or soak it in a tub. Do *not* wash the prefilter(s) in the dishwasher or car wash.

Cleaning your Cells

1. A quick cleaning of the cells can be done by simply wiping down the ionizer wires with a damp cloth. This will help boost the efficiency of the air cleaner between full cleaning cycles. This quick clean can be done every time the prefilters are cleaned.
2. A full cleaning of the cells will return the air cleaner to its peak efficiency. An easy way to wash the cells is in a tub of hot, soapy water. Just soak the cells until the water cools, agitate and rinse. For details on cleaning cells, see below for Washing the cell(s) in a tub or Washing the cell(s) in your automatic dishwasher.
3. Because the efficiency of the air cleaner remains high even as it loads up with dirt, a full cleaning of the cells can be put off for yearly maintenance and a quick cleaning can be done more often. Those wishing to renew to peak efficiency or with heavier use may want to wash more frequently.

Replacing your Postfilter

1. The postfilter is an optional filter that boosts the efficiency of the air cleaner. Do not wash the postfilter because that will neutralize the factory applied charge.
2. The postfilter should be replaced every six months to ensure peak performance.



CAUTION

Burn Hazard.

Can cause personal injury.

Allow cell(s) to cool completely in dishwasher and at end of wash cycle or wear protective gloves.

Washing the cell(s) in your automatic dishwasher

Hot water can accumulate in the tubes supporting the collector plates. Tip the cell(s) so these tubes can drain.

IMPORTANT

- Check your dishwasher Owner's manual. Some manufacturers do not recommend washing electronic cell(s) in their dishwashers.
 - If the dishwasher has upper and lower arms, position the cell(s) carefully to allow good water circulation.
 - Be careful to avoid damaging the cell(s) when placing them in the dishwasher. Broken ionizer wires or bent collector plates are not covered under the Warranty.
 - Very dirty cell(s), especially from tobacco or cooking smoke, can discolor the plastic parts and the lining of some dishwashers. This discoloration is not harmful. To minimize it, wash the cell(s) more frequently or try a different brand of detergent.
 - Do NOT allow the dishwasher to run through the dry cycle. This bakes on any contaminants not removed during the wash cycle and reduces air cleaner efficiency.
1. Put the cell(s) on the lower rack of the dishwasher with the airflow arrow pointing up. It may be necessary to remove the upper rack. Do not block water flow to the upper arm.

HINT: Lay a few large water glasses between the spikes on the lower rack, and rest the cell(s) on them so the spikes do not damage the aluminum collector blades.

2. Using your regular dishwashing detergent, allow the dishwasher to run through the complete wash and rinse cycle. Do not use the dry cycle. To avoid burns, let the cell(s) cool completely before removing, or wear protective gloves when removing the cell(s). Remember that water may be trapped inside the cell(s) plates. Tip the cell(s) so these tubes can drain.
3. Wipe the ionizer wires and contact board on the end of the cell using your thumb and forefinger with a small, damp cloth.
4. Inspect the dishwasher. You may want to rerun the wash and/or rinse cycle with the dishwasher empty if you see dirt or residue from washing the cell(s). If dirt or residue seems excessive, wash the cell(s) more often or try a different detergent.



CAUTION

Hazardous Chemical.

Can cause personal injury.

Do not splash detergent solution in eyes.

Washing the cell(s) in a tub

- Wear rubber gloves to avoid prolonged detergent contact with your skin.
- Keep detergent and solution out of reach of children.

NOTE: Always wash the cell(s) first, then the prefilter(s), to keep heavy prefilter lint from getting caught in the cell(s).

1. Use a large enough container, such as a laundry tub or trash container, to hold one or both cell(s).

NOTE: Sharp corners on the cell(s) can scratch the surface of a bathtub.

2. Dissolve about three-fourth cup of automatic dishwasher detergent per cell in enough hot water to cover the cell(s). If the detergent does not dissolve readily, or forms a scum on the water, try another brand, or use softened water.
3. After the detergent has completely dissolved, place the cell(s) in the container and allow to soak for 15 to 20 minutes or until water cools. Agitate them up and down a few times and remove. Repeat steps 2 and 3, if necessary, for very dirty cells.
4. Next, wash the prefilter(s) the same way. Empty and rinse the wash container.
5. Rinse the cell(s) with a hard spray of very hot water; rinse the tub clean, then fill the tub with clean hot water and soak for 5 to 15 minutes. Rinse until the water draining from the cell(s) and prefilter(s) no longer feels slippery.
6. Soak cell(s) in a final clear water rinse for ten minutes.
7. Wipe the ionizer wires and contact board on the end of the cell using your thumb and forefinger with a small, damp cloth.

Replacing electronic air cleaner components

1. Inspect the cell(s) for broken ionizer wires and bent collector plates. Repair, as necessary, or call your contractor for service.
2. Slide the prefilter(s) into the upstream prefilter guides.
3. Slide the air cleaner cell(s) in so the air flow arrow points downstream and the handle(s) face outward.
4. Firmly close the access door.
5. Turn on the air cleaner. If the cell(s) and prefilter(s) are wet, the neon light may not come on and you may hear arcing. If the arcing is annoying, simply turn the air cleaner off for two to three hours or until the cell(s) are dry.

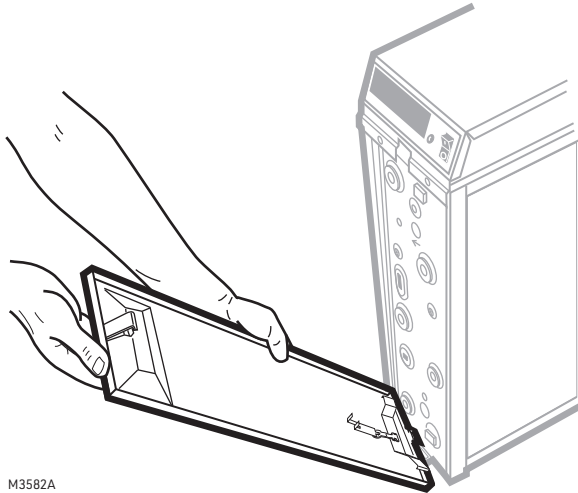

HOW ELECTRONIC AIR CLEANING WORKS

A word about particle size

The particles removed by the electronic air cleaner tend to be very small—less than ten microns. But what is a ten-micron particle? The eye of an average size sewing needle is about 750 microns across, and the dot in the i in the word micron is about 400 microns. Generally, particles smaller than ten microns can be seen only with a microscope, except in very large concentrations, such as a puff of smoke. Your electronic air cleaner can remove even smaller particles that can be seen only with an electron microscope.

Although particles one micron and smaller make up only about 20 percent of the total weight of particles in unfiltered air, they account for over 99 percent of the numbers of particles.

Because they are so tiny, these particles tend to remain suspended in the air unless they collide with a solid surface. Then they attach by molecular adhesion and stick like glue, staining walls and furniture and coating your air conditioning coils. And of course, some of these particles can cause allergic reactions or simply make the environment less pleasant.

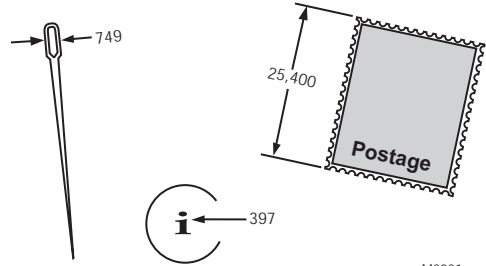

How the electronic air cleaner works

First, large particles (lint, hair) are caught by the prefilter(s). Then, as the dirty air passes through the intense high voltage electric field surrounding the ionizer wires, all particles, even the smallest particles down to 0.3 micron are given an electric charge. The air then passes into the collector where the alternate parallel plates are charged positive and negative, creating a uniform electrostatic field. Since opposites attract, the charged particles stick to the collector plates, having an opposite electric charge. The precharged postfilter continues to remove small particles from the air. The air leaving the air cleaner contains very few particles.

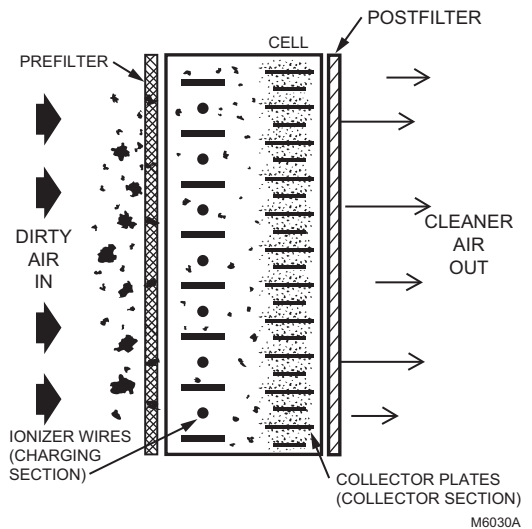

Each time the air circulates through the heating/air conditioning system and air cleaner, more particles are removed. These particles are generated by normal household activities and also enter the house from outside. That is the reason we recommend that you use the air cleaner as much as possible.

Electronic air cleaner vs standard furnace filter

The regular furnace filter collects mainly large, visible particles that reach the filter. Its main purpose is to protect the furnace and air conditioner blower. The electronic air cleaner collects these large particles plus many of the smaller, mostly invisible particles. Its purpose is to reduce indoor air pollution as well as to protect the blower, air conditioning coils and heat exchanger.

Ozone and the electronic air cleaner

Electronic air cleaners generate a very small amount of ozone, about 0.005 to 0.010 parts per million (ppm). The amount is highest when the air cleaner is new.

The average person can detect the odor of ozone in concentrations as low as 0.003 to 0.010 ppm. The U.S. Food and Drug Administration, and Health and Welfare Canada recommend that indoor ozone concentration should not exceed 0.050 ppm. As a comparison, the outdoor ozone level in major cities is sometimes higher than 0.100 ppm.

If desired, the ozone generated by the air cleaner can be reduced by asking your dealer to:

- Install an activated carbon filter downstream of the air cleaner, or
- Adjust the air cleaner power supply to reduce ozone production. This adjustment reduces ozone production about 20–25 percent, but also reduces air cleaning efficiency about seven to ten percent.

About lint or “white dust”

White dust is made up of particles that settle out of the air before they get to the return air duct. You can help prevent this white dust from settling by running your fan constantly and:

- Be sure the return registers are not blocked with furniture.
- Be sure the discharge ducts are clean (best done before installing the air cleaner).
- Be sure your clothes dryer is vented to the outside and is not plugged.
- If you have new rugs or drapes or new woolen blankets, be aware that the lint from these items will reduce with age.
- In new or remodeled homes, plaster dust or paint pigment may contribute to white dust, but will reduce with time.
- Use of a humidifier may contribute to *white dust*, especially if filled with undistilled water.

BEFORE YOU CALL FOR SERVICE

If...

Then...

Electronic air cleaner doesn't seem to be working

1. Make sure the furnace or air conditioner blower is running.
2. Make sure the access door is firmly closed and latched. If door is not closed properly, an interlock keeps the air cleaner off.

Arcing (snapping) seems too frequent

1. If the electronic cell(s) are wet from washing, turn the air cleaner off for two to three hours.
2. Check the cell(s) for broken ionizer wires or bent plates. Repair if necessary.
3. Wash cell(s) and prefilter(s) if dirty.

Neon light on air cleaner does not come on

1. Make sure the furnace or air conditioner fan is running.
2. Make sure the access door is firmly closed.
3. Make sure the On-Off switch is in the On position.
4. On models without the Solid State Performance Indicator, if the electronic cell(s) are wet, check again in two to three hours.

You smell ozone and find it objectionable

Call your heating and air conditioning dealer.

RESIDEO 10 YEAR UltraClean COIL GUARANTEE™

Send to:
Resideo 10 Year
UltraClean Coil Guarantee
Customer Care, MN10-1461
1885 Douglas Drive North
Golden Valley, MN 55422

Guarantee

If you properly maintain your new Resideo Electronic Air Cleaner (EAC), Resideo guarantees that if your indoor coil requires cleaning within the next 10 years, Resideo will pay

to have it professionally cleaned by a qualified contractor:

- 75% of the cost (up to \$150) when installed with a Resideo Coil Irradiation Ultraviolet Air Treatment System or
 - 50% of the cost (up to \$100) if a Resideo EAC is installed without a Resideo Coil Irradiation Ultraviolet Air Treatment System).
- The UltraClean Coil Guarantee™ applies to any Resideo Electronic Air Cleaner properly installed with a heat pump, air conditioner or high efficiency furnace that is: brand new, less than one year old; or more than one year old with the indoor coil professionally cleaned by a qualified contractor prior to installation.
 - Proper maintenance on the EAC means: keep the power switch in the On position, periodically verify power operation, and wash electronic cells periodically as specified in this Owner's Guide.
 - Proper maintenance on the Electronic Air Cleaner means: periodically clean the lamp glass and replace UV lamps as specified in the Owner's Guide.

How to register your guarantee

The UltraClean Coil Guarantee™ begins the day you move into your new home, or the day the Air Cleaner is installed. To register your guarantee, complete the Registration Card in the back of this Owner's Guide and enclose:

- Proof of purchase of a Resideo duct-mounted Electronic Air Cleaner and Coil Irradiation Ultraviolet Air Treatment System.
- Proof of purchase of a new heating/cooling system within the last year, or...
- Proof of professional coil cleaning services on existing equipment.
- If your home is new and invoices are not available, simply complete the form.

LIMITED FIVE-YEAR WARRANTY

Resideo warrants this product, excluding battery, to be free from defects in workmanship or materials, under normal use and service, for a period of five (5) years from the date of first purchase by the original purchaser. If at any time during the warranty period the product is determined to be defective due to workmanship or materials, Resideo shall repair or replace it (at Resideo's option).

If the product is defective,

(i) return it, with a bill of sale or other dated proof of purchase, to the place from which you purchased it; or

(ii) call Resideo Customer Care at 1-800-468-1502. Customer Care will make the determination whether the product should be returned to the following address: Resideo Return Goods, 1985 Douglas Dr. N., Golden Valley, MN 55422, or whether a replacement product can be sent to you.

This warranty does not cover removal or reinstallation costs. This warranty shall not apply if it is shown by Resideo that the defect was caused by damage which occurred while the product was in the possession of a consumer.

Resideo's sole responsibility shall be to repair or replace the product within the terms stated above. RESIDEO SHALL NOT BE LIABLE FOR ANY LOSS OR DAMAGE OF ANY KIND, INCLUDING ANY INCIDENTAL OR CONSEQUENTIAL DAMAGES RESULTING, DIRECTLY OR INDIRECTLY, FROM ANY BREACH OF ANY WARRANTY, EXPRESS OR IMPLIED, OR ANY OTHER FAILURE OF THIS PRODUCT.

Some states do not allow the exclusion or limitation of incidental or consequential damages, so this limitation may not apply to you.

THIS WARRANTY IS THE ONLY EXPRESS WARRANTY RESIDEO MAKES ON THIS PRODUCT. THE DURATION OF ANY IMPLIED WARRANTIES, INCLUDING THE WARRANTIES OF MERCHANTABILITY AND FITNESS FOR A PARTICULAR PURPOSE, IS HEREBY LIMITED TO THE FIVE YEAR DURATION OF THIS WARRANTY. Some states do not allow limitations on how long an implied warranty lasts, so the above limitation may not apply to you.

This warranty gives you specific legal rights, and you may have other rights which vary from state to state. If you have any questions concerning this warranty, please write Resideo Customer Care, 1985 Douglas Dr, Golden Valley, MN 55422 or call 1-800-468-1502.

Warranty Registration

Register your warranty on-line at www.Resideo.com under Product Registration or send the following form to:

Resideo Customer Care
MN10-1461
1885 Douglas Dr N
Golden Valley, MN 55422

Resideo 10 Year UltraClean Coil Guarantee™

Your Name _____
 Street Address _____ City _____
 State _____ Zip Code _____
 Phone: Day _____ Evening _____
 Email _____
 Date you moved in (for new home) _____

Please check UltraClean Coil Guarantee™ or Clean Coil Guarantee™ (see program details for explanation):

- UltraClean Coil Guarantee™.
- Clean Coil Guarantee™.

Your heating/cooling contractor or builder _____
 Street Address: _____
 City _____ State _____ Zip Code _____
 Phone: _____

Attn Mailroom: Please direct to Customer Care, MN10-1461.

Product Registration

(Register online @ www.Resideo.com)

1. Mr___ Mrs___ Ms___ Miss___
First Name:_____ Initial:___ Last Name:_____
Address (Number and Street):_____ Apt:_____
Zip or Postal Code _____
City:_____ State/Province:_____
email Address:_____
2. Phone Number:_____
3. Date of Purchase (month/day/year) ex: January/18/98:
Purchase Price: \$ _____(excluding tax)
4. Where did you purchase this Resideo product:
Heating/cooling contractor_____ Utility company_____
Builder/came with new home_____ Other_____
5. Model Number_____
6. How many other Resideo products do you own:
None___ One___ Two___ Three___ Four or more___
7. Your date of birth (month/day/year) ex. January/18/69:

8. Education: High School___ Some College___
Technical School___ Completed College___
Graduate School___ Other_____
9. For your primary residence, do you:
Own___ Rent___
10. Including yourself, what is the total number of people
living in your household? (Ex. 01, 02, 03 ... xx):_____
11. Your marital status: Married___ Single___
12. Which best describes your family income?
Under \$15,000___ \$15,000 - \$24,999___
\$25,000___ \$35,000___ \$50,000___ \$75,000___
\$100,000 - \$149,999___ Over \$150,000___



Resideo Technologies, Inc.
1985 Douglas Drive North, Golden Valley, MN 55422
1-800-468-1502
69-0756-07 M.S. Rev. 02-22 | Printed in United States