

Instant[™] MILK FROTHER[™]



User Manual

- 01** Get Started
- 02** Make Some Foam
- 03** Warranty and Contact Info



For more information and how-to videos,
visit instantappliances.com/milkfrother

IMPORTANT SAFEGUARDS



(Yes, we have to)

At Instant Brands, your safety always comes first. Enjoy using your Instant™ Milk Frother, knowing it was designed to be quick, easy, and completely safe to use.

As always, be cautious when using electrical appliances and follow basic safety precautions.

READ ALL INSTRUCTIONS, SAFEGUARDS AND WARNINGS BEFORE USE. FAILURE TO FOLLOW THESE SAFEGUARDS AND INSTRUCTIONS MAY RESULT IN INJURY AND/OR PROPERTY DAMAGE.

- 01** For countertop use only. Always operate the appliance on a stable, non-combustible, level surface.
- 02** For household use only. Not for commercial use. **DO NOT** use the appliance for anything other than its intended use.
- 03** Make sure that your outlet voltage corresponds to the voltage stated on the rating label, located on the sticker under the base.
- 04** **DO NOT** operate the appliance while the pitcher is empty.
- 05** Avoid spillage on the connector.
- 06** To protect against fire, electric shock and injury to persons, **DO NOT** immerse the power cord, plug, pitcher or the appliance base in water or other liquid.
- 07** Unplug from outlet when not in use and before cleaning. After using a program that heats, there will be residual heat within the pitcher. Allow the appliance to cool before putting on or taking off parts, and before cleaning.

WARNING

Read this manual carefully and completely and retain for future reference. Failure to adhere to safety instructions may result in serious injury or damage.

IMPORTANT SAFEGUARDS

- 08 Regularly inspect the appliance and power cord. DO NOT operate the appliance if the power cord or plug is damaged, or after the appliance malfunctions or is dropped or damaged in any manner. For assistance, contact Customer Care at support@instantappliances.com, [instantappliances.com/#chat](https://www.instantappliances.com/#chat), or by phone at 1-800-828-7280.
- 09 DO NOT let the power cord hang over the edge of tables or counters, and DO NOT allow it to touch hot surfaces.
- 10 DO NOT place the appliance on or near a hot gas or electric burner, or in a heated oven.
- 11 Fill the pitcher with only milk or non-dairy milk alternatives. Never fill the pitcher with oil or other liquids. DO NOT fill past the appropriate **MAX** fill lines for your desired setting, as hot liquid may be ejected.
- 12 Always operate the appliance with the lid in place. DO NOT remove the lid while frothing to avoid scalding injury.
- 13 Avoid contacting moving parts. Keep hands and utensils out of the pitcher while frothing to reduce the risk of personal injury and/or property damage.
- 14 Some parts of the appliance are hot when the appliance is in operation. Only use the handle to move or carry the pitcher.
- 15 Extreme caution must be used when moving the appliance when it contains hot liquids.

WARNING

Read this manual carefully and completely and retain for future reference. Failure to adhere to safety instructions may result in serious injury or damage.

IMPORTANT SAFEGUARDS

- 16 To disconnect, press the **Start/Cancel** button and ensure the unit is off, then unplug the base from the power source. To unplug safely, grasp the plug and remove from the outlet. Never pull from the power cord.
- 17 DO NOT use the appliance outdoors. Never leave the appliance exposed to sun, wind, rain and/or snow.
- 18 DO NOT leave the appliance unattended when in use.
- 19 This appliance is NOT to be used by children or by persons with reduced physical, sensory or mental capabilities. Close supervision is necessary when any appliance is used near children and these individuals. Children should not play with this appliance.
- 20 The use of accessories not recommended by the manufacturer may result in fire, electric shock or injury to persons.
- 21 The appliance is only to be used with the base provided.
- 22 Extension cords are available and may be used if care is exercised in their use:
 - The marked electrical rating of the extension cord should be at least as great as the electrical rating of the appliance;
 - The longer cord should be arranged so that it will not drape over the counter top or table top where it can be pulled on by children or tripped over.

SAVE THESE INSTRUCTIONS.

WARNING

Read this manual carefully and completely and retain for future reference. Failure to adhere to safety instructions may result in serious injury or damage.

IMPORTANT SAFEGUARDS

⚠ WARNING

To avoid injury, read and understand the instructions in this user manual before attempting to use this appliance.

⚠ WARNING

Electrical shock hazard.

- DO NOT use an adapter.
- DO NOT remove the bottom cover. No user-serviceable parts inside. Repair should be done by authorized service personnel only.

Failure to follow these instructions may result in electric shock and/or death.

⚠ WARNING

THE FAILURE TO FOLLOW ANY OF THE IMPORTANT SAFEGUARDS AND/OR THE INSTRUCTIONS FOR SAFE USE IS A MISUSE OF YOUR APPLIANCE THAT CAN VOID YOUR WARRANTY AND CREATE THE RISK OF SERIOUS INJURY.

Special cord set instructions

As per safety requirement, a short power supply cord (0.6 m to 0.9 m / 24" to 35") is provided to reduce the hazards resulting from grabbing, entanglement and tripping.

This appliance has a polarized plug and one blade is wider than the other. To reduce the risk of electric shock, the plug is intended to fit into a polarized outlet only one way. If the plug does not fit fully into the outlet, reverse the plug. If it still does not fit, contact a qualified electrician.

DO NOT attempt to modify the plug in any way.

⚠ WARNING

Read this manual carefully and completely and retain for future reference. Failure to adhere to safety instructions may result in serious injury or damage.

Table of contents

- Product specifications..... 6**
- Let’s get started!..... 7**
 - So, what’s in the box?..... 7
- Product, parts and accessories 8**
- Initial setup..... 9**
- Initial cleaning..... 9**
- Making drinks 10**
 - Set up the frother for use. 11
 - Settings 12
 - Frothing tips 13
- Care, cleaning and storage 14**
- Troubleshooting 15**
- Warranty 16**
- Contact us..... 18**

Product specifications

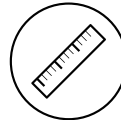
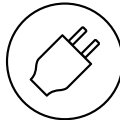

Model: Instant Milk Frother	10 oz. 296 mL	120 V~60 Hz	500 W	lbs: 1.7 kg: 0.77	in: 6.2 L x 4.7 W x 8.8 H cm: 15.8 L x 12 W x 22.3 H
-----------------------------------	------------------	-------------	-------	----------------------	---

Let's get started!

So, what's in the box?

Before using your new milk frother, make sure everything is present and accounted for.

- Instant Milk Frother
- Frothing paddle
- Lid
- Base with cord
- User manual

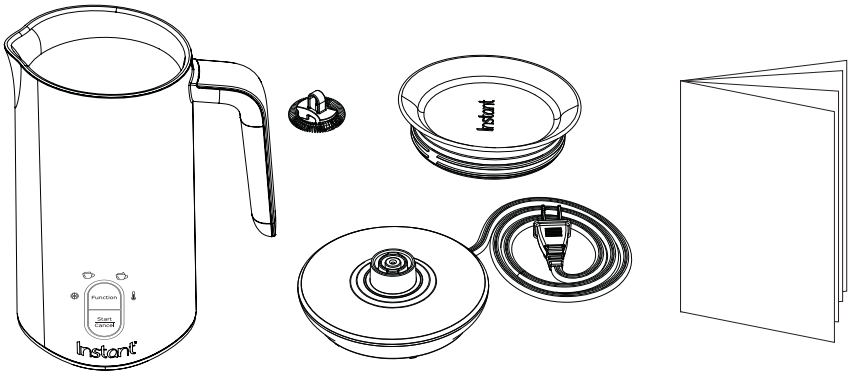

See **Product, parts and accessories** for a full parts breakdown.

For more information and how-to videos, visit instantappliances.com/milkfrother.

Is something missing or damaged?

Contact a Customer Care Advisor by chat at instantappliances.com/#chat, by e-mail at support@instantappliances.com, or by phone at 1-800-828-7280.

Product, parts and accessories

Instant Milk Frother

Make sure everything is installed properly before use.

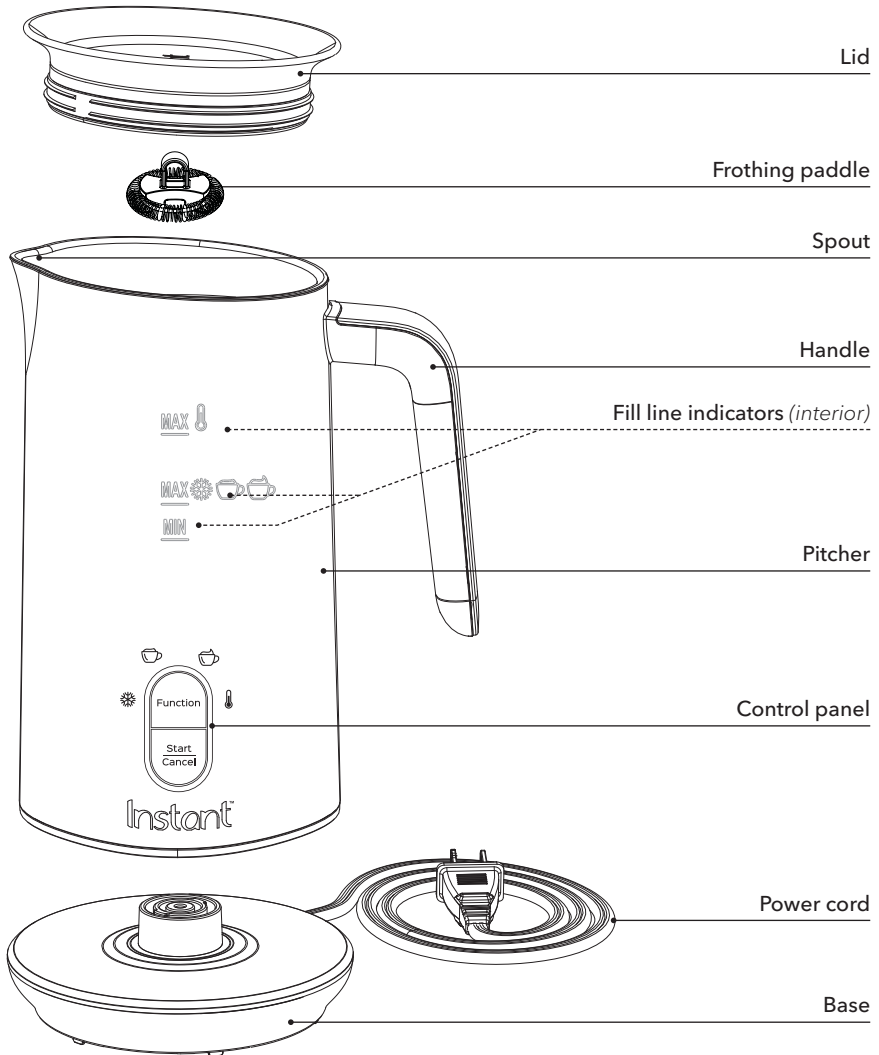

Illustrations in this document are for reference only and may differ from the actual product. Always refer to the actual product.

Initial setup

Is your drink missing a little somethin' somethin'? Get this little guy going and start showing off your foam flair.

- 01** Pull your new milk frother out of the box!
- 02** Remove all the packaging material and accessories from in and around the appliance. Make sure to check inside the pitcher!
- 03** Place the milk frother base on a stable, level surface.
- 04** Follow the instructions in **Initial cleaning** before frothing for the first time.

Initial cleaning

Before using your milk frother, it's important to clean the components.

- 01** Disassemble the milk frother into 3 parts:
 - The lid
 - The frothing paddle (pull up gently to remove)
 - The pitcher
- 02** Hand wash the lid, the frothing paddle, and the inside of the pitcher with hot water and dish soap. Do not immerse the pitcher in water or other liquid.
- 03** Rinse the lid, the frothing paddle, and the inside of the pitcher with clear, warm water, then dry them thoroughly with a soft cloth.

That's it! Start whipping up that fresh, fluffy foam.

WARNING

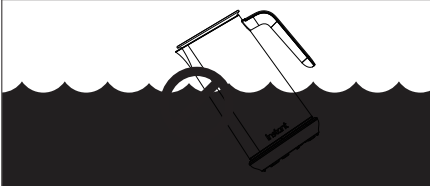

The pitcher and base contain electrical components. To avoid fire, electric shock or personal injury, **DO NOT** machine wash, rinse or immerse the milk frother base, pitcher, power cord or plug in water or other liquids.

Making drinks

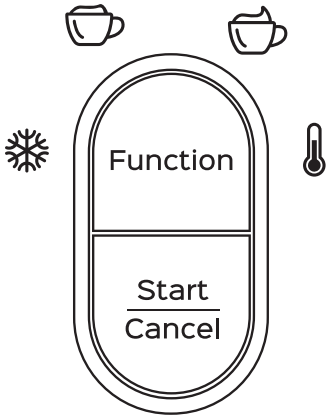

The Instant Milk Frother was designed with 2 easy-to-use button controls.

Function

Toggles through the preset programs to create various types of foam to suit your tastes.

Start/Cancel

Starts and stops the selected program.



The **cold foam** setting creates a luscious, silky microfoam filled with millions of tiny bubbles. Use milk and coconut milk for the perfect cold brew topper.



The Milk Frother does not chill when frothing. Use chilled liquid.



The **warm foam** setting heats and froths, and with a gentle swirl of the pitcher at the end, creates a loose style of warm microfoam – like a cloud floating on your café au lait and lattes.



The **warm, thick foam** setting heats and froths your liquid to create a rich, dense style of warm microfoam. The crowning touch for your cappuccino.



The **warm, no foam** setting heats your drink without generating any foam. This setting automatically slow-stirs your drink to keep it from scorching, for amazing steamed milk, hot chocolate and more!

Making drinks

Set up the Milk Frother for use

- 01** Remove the lid from the pitcher.
- 02** Position the square end of the frothing paddle over the shaft at the bottom of the pitcher.

Rotate the frothing paddle until it aligns with the shaft, then push the frothing paddle down until it is secure.

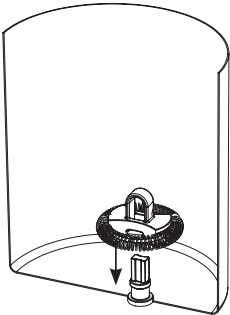

- 03** For cold foam, warm foam, or warm, thick foam, fill the pitcher to between the **MIN** and **MAX** ☀️☕☕ lines.

To warm without creating foam, fill the pitcher to between the **MIN** and **MAX** 🌡️ lines.

 Overfilling may cause the milk frother to overflow when using a foaming setting. Do not overfill the pitcher.

- 04** Place the lid on the pitcher and press down until it is secure.
- 05** Place the pitcher on the base.
- 06** Connect the power cord to a 120 V outlet.

NOTICE

Do not attempt to froth if the liquid level is below the **MIN** fill line as indicated on the inside of the pitcher.

⚠️ WARNING

DO NOT remove the lid while the frothing paddle is in operation to avoid risk of electric shock, personal injury and/or property damage.

Making drinks

Settings

01 Press **Function** to toggle between all settings.

 Cold foam

 Warm foam

 Warm, thick foam

 Warm, no foam

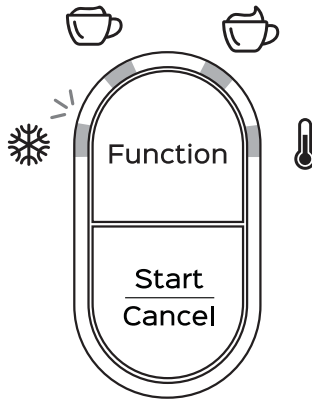

The light that corresponds to the selected program blinks.

02 Press **Start/Cancel**.

The light stays illuminated and the program starts after a few seconds.

03 To stop the program at any time, press **Start/Cancel**.

When the program ends, the milk frother stops.



Programs will only run for a maximum of 3 minutes.

Frothing tips

Follow these tips and tricks to make sure you're treating yourself to the best drink possible.

Tip	How to do it and why
The colder the liquid the better.	<p>Always use the coldest, freshest milk or milk alternative possible before frothing.</p> <p>When frothing, millions of tiny air bubbles are introduced into the liquid. The longer it takes to heat up, the more air can be infused into the liquid. This immediately enhances the quality of your foam, and reduces your chances of scalding. No more bad froth days!</p> <p>Note: Warm milk will not foam up properly.</p>
Not all milk alternatives produce foam.	<p>Oat and soy milk will create foam using either the warm or cold foaming settings.</p> <p>Coconut milk will only froth using the cold foam setting.</p>
Infuse your foam with flavor.	<p>Before frothing, add aromatic spices to the pitcher, like cinnamon, cardamom or nutmeg, or other fragrant items like lavender. The longer you allow your ingredients to steep, the stronger the flavors will be.</p> <p>It's a tasty mix and match! Join the official Instant Pot® Facebook Community to let us know your favorite bevvy's unique flavor profile.</p>
Give your milk frother a break!	<p>When frothing big batches, allow the milk frother to rest for about 3 minutes after every 2 frothing cycles.</p>
Making latte worthy foam.	<p>As soon as the frother finishes whipping up your warm foam, lift the pitcher off the base, put your thumb on the lid and give it a good swirl! This helps give your latte foam the glossiness it deserves.</p>

Care, cleaning and storage

Clean your Instant Milk Frother after every use to ensure the best possible flavor and to prevent milk from baking onto the inside of the pitcher.

Always unplug the milk frother and let it cool to room temperature before cleaning. Never use metal scouring pads, abrasive powders or harsh chemical detergents on any of the milk frother's parts or components.

Let all parts dry thoroughly before use or before storage.

Parts	Cleaning methods and instruction
Lid	Remove from the pitcher before cleaning. Dishwasher safe.
Pitcher	Remove the pitcher from the base before cleaning. With a cloth, hand wash the inside of the pitcher with hot water and dish soap and rinse it with clean, warm water. With a barely-damp cloth, hand wash the outside of the pitcher and wipe dry to prevent streaking. DO NOT rinse the pitcher's exterior. DO NOT store liquid in the pitcher.
Frothing paddle	Remove from the pitcher before cleaning. Dishwasher safe.
Base	With a barely damp cloth, wipe visible particles from the base as needed. Allow to dry thoroughly before placing the pitcher.
Power cord	With a barely damp cloth, wipe visible particles from the power cord as needed. DO NOT fold the power cord when storing.

⚠ WARNING

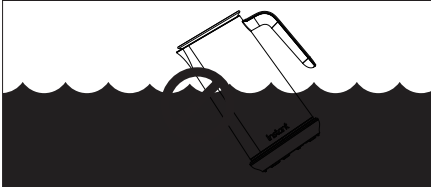

The pitcher and base contain electrical components. To avoid fire, electric shock or personal injury, DO NOT machine wash, rinse or immerse the milk frother base, pitcher, power cord or plug in water or other liquids.

Troubleshooting

Register your Instant Milk Frother today at instantappliances.com/support/register.

Contact a Customer Care Advisor by chat at instantappliances.com/#chat, by e-mail at support@instantappliances.com, or by phone at 1-800-828-7280.

For more troubleshooting tips go to instantappliances.com/milkfrother.

Resolution table

Problem	Possible reason	Try this
Milk is not frothing.	The frothing paddle is not installed correctly.	Remove the liquid from the pitcher. Position the square end of the frother paddle over the shaft at the bottom of the pitcher and push down until it is secure.
	Milk is too hot.	Put your milk in the fridge or freezer to bring the temperature down.
	The inside of the pitcher or the frothing paddle contains milk residue.	Clean the pitcher and frothing paddle according to Care, cleaning and storage instructions.
	Different types and brands of milk and non-dairy milk alternatives may froth differently.	Experiment to find your favorite foam.
The Warm Foam and the Warm Thick Foam lights blink repeatedly.	The milk frother has overheated.	Unplug and wait up to 10 mins for the milk frother to cool before further use.
All four LEDs blink repeatedly.	The unit is defective or damaged.	The unit needs to be serviced by an authorized service representative. Contact Customer Care.

Any other servicing should be performed by an authorized service representative.

Warranty

Limited Warranty

This Limited Warranty is effective for one year from the date of original consumer purchase. Proof of original purchase date and, if requested by an authorized representative of Instant Brands Inc. ("Instant Brands"), return of your appliance, is required to obtain service under this Limited Warranty. Provided that this appliance is operated and maintained in accordance with written instructions attached to or furnished with the appliance, Instant Brands will, in its sole and exclusive discretion, either: (i) repair defects in materials or workmanship; or (ii) replace the appliance. In the event that your appliance is replaced, the Limited Warranty on the replacement appliance will expire 12 months from the date of original consumer purchase.

This Limited Warranty extends only to the original purchaser and use of the appliance in the United States of America and Canada. This warranty does not cover units that are used outside of the United States of America and Canada.

Any modification or attempted modification to your appliance may interfere with the safe operation of the appliance and will void this Limited Warranty. This Limited Warranty does not apply in respect of any appliance or any part thereof that has been altered or modified unless such alterations or modifications were expressly authorized by an Instant Brands representative.

Limitation and Exclusions

The liability of Instant Brands, if any, for any allegedly defective appliance or part shall in no circumstances exceed the purchase price of a comparable replacement appliance.

This Limited Warranty does not cover:

1. Damage resulting from accident, alteration, misuse, abuse, neglect, unreasonable use, use contrary to the operating instructions, normal wear and tear, commercial use, improper assembly, disassembly, failure to provide reasonable and necessary maintenance, fire, flood, acts of God or repair by anyone unless directed by an Instant Brands Representative;
2. Repairs where your appliance is used for other than normal, personal use or when it is used in a manner that is contrary to published user or operator instructions; or
3. Use of unauthorized parts and accessories, or repairs to parts and systems resulting from unauthorized repairs or modifications made to this appliance.

The cost of repair or replacement under these excluded circumstances shall be paid by you.

Warranty

Disclaimer of Implied Warranties

EXCEPT AS EXPRESSLY PROVIDED HEREIN AND TO THE EXTENT PERMITTED BY LAW, INSTANT BRANDS MAKES NO WARRANTIES, CONDITIONS OR REPRESENTATIONS, EXPRESS OR IMPLIED, BY STATUTE, USAGE, CUSTOM OF TRADE OR OTHERWISE WITH RESPECT TO THE APPLIANCES OR PARTS COVERED BY THIS WARRANTY, INCLUDING BUT NOT LIMITED TO, WARRANTIES, CONDITIONS, OR REPRESENTATIONS OF WORKMANSHIP, MERCHANTABILITY, MERCHANTABLE QUALITY, FITNESS FOR A PARTICULAR PURPOSE OR DURABILITY.

Some states or provinces do not allow for the exclusion of implied warranties of merchantability or fitness, so this limitation may not apply to you. In these states and provinces, you have only the implied warranties that are expressly required to be provided in accordance with applicable law.

Limitation of Remedies; Exclusion of Incidental and Consequential Damage

YOUR SOLE AND EXCLUSIVE REMEDY UNDER THIS LIMITED WARRANTY SHALL BE APPLIANCE REPAIR OR REPLACEMENT AS PROVIDED HEREIN. INSTANT BRANDS SHALL NOT BE LIABLE FOR INDIRECT, INCIDENTAL OR CONSEQUENTIAL DAMAGES ARISING OUT OF OR IN CONNECTION WITH THE USE OR PERFORMANCE OF THE APPLIANCE OR DAMAGES WITH RESPECT TO ANY ECONOMIC LOSS, PERSONAL INJURY, LOSS OF PROPERTY, LOSS OF REVENUES OR PROFITS, LOSS OF ENJOYMENT OR USE, COSTS OF REMOVAL, INSTALLATION OR OTHER INDIRECT, INCIDENTAL OR CONSEQUENTIAL DAMAGES OF ANY NATURE OR KIND.

Warranty Registration

Please visit www.instantappliances.com/support/register to register your new Instant Brands™ appliance and validate your warranty within thirty (30) days of purchase. You will be asked to provide the store name, date of purchase, model number (found on the back of your appliance) and serial number (found on the bottom of your appliance) along with your name and email address. The registration will enable us to keep you up to date with product developments, recipes and contact you in the unlikely event of a product safety notification. By registering, you acknowledge that you have read and understand the instructions for use, and warnings set forth in the accompanying instructions.

Warranty Service

To obtain service under this warranty, please contact our Customer Service Department by phone at 1-800-828-7280 or by email to support@instantappliances.com. You can also create a support ticket online at www.instantappliances.com/support. If we are unable to resolve the problem, you may be asked to send your appliance to the Service Department for quality inspection. Instant Brands is not responsible for shipping costs related to warranty service, save and except for shipping costs associated with the return of your appliance from Canada or within the 48 contiguous states and the District of Columbia of the United States of America, as provided herein. When returning your appliance, please include your name, mailing address, email address, phone number, and proof of the original purchase date as well as a description of the problem you are encountering with the appliance.

Instant™

Instant Brands Inc.

11–300 Earl Grey Dr., Suite 383
Ottawa, Ontario
K2T 1C1
Canada

Register your product today

instantappliances.com/support/register

Contact us

1-800-828-7280
support@instantappliances.com
instantappliances.com/#Chat



instantappliances.com
store.instantpot.com

