

# Instant Pot®

## PRO™ PLUS

MULTI-USE PRESSURE COOKER - 6 QUART



### User manual

Important safeguards

Products, parts and accessories

Get started

Pressure cooking 101

Releasing pressure

Control panel

Pressure control features

Canning 101

Cooking

Care, cleaning and storage

Troubleshooting

Warranty

Contact

Register your product today at [instantpot.com/support/register](https://instantpot.com/support/register).  
Download the Instant Pot App for 1000+ recipes at [instantpot.com/app](https://instantpot.com/app).



# IMPORTANT SAFEGUARDS



(Yes, we have to)

At Instant Brands™ your safety always comes first. The Instant Pot® Pro Plus was designed with your safety in mind, and we mean business. Check out this Instant Pot's long list of safety mechanisms on [instantpot.com](https://instantpot.com) to see what we mean.

As always, be cautious when using electrical appliances and follow basic safety precautions.

- 01** READ ALL INSTRUCTIONS, SAFEGUARDS AND WARNINGS BEFORE USE. FAILURE TO FOLLOW THESE SAFEGUARDS AND INSTRUCTIONS MAY RESULT IN INJURY AND/OR PROPERTY DAMAGE.
- 02** Use only the Instant Pot Pro Plus lid with the Instant Pot Pro Plus multicooker base. Using any other pressure cooker lids may cause injury and/or damage.
- 03** For household use only. Not for commercial use. Do not use the appliance for anything other than its intended use.
- 04** For countertop use only. Always operate the appliance on a stable, non-combustible, level surface.
  - Do not place on anything that may block the vents on the bottom of the appliance.
  - Do not place on a hot stove.
- 05** Heat from an external source will damage the appliance.
  - DO NOT place the appliance on or close to a hot gas or electric burner, or a heated oven.
  - DO NOT use the appliance near water or flame.
  - DO NOT use outdoors. Keep out of direct sunlight.
- 06** DO NOT touch the appliance's hot surfaces. Only use the side handles for carrying or moving.
  - DO NOT move the appliance when it is under pressure.
  - DO NOT touch accessories during or immediately after cooking.

## WARNING

Read this manual carefully and completely and retain for future reference. Failure to adhere to safety instructions may result in serious injury or damage.

# IMPORTANT SAFEGUARDS



- DO NOT touch the metal portion of the lid when the appliance is in operation; this could result in injury.
  - Always use proper hand protection when removing hot accessories, and to handle the hot inner pot.
  - Always place hot accessories on a heat-resistant surface or cooking plate.
- 07** The removable inner pot can be extremely heavy when full of ingredients. Care should be taken when lifting the inner pot from the multicooker base to avoid burn injury.
- Extreme caution must be used when the inner pot contains hot food, hot oil or other hot liquids.
  - Do not move the appliance while it is in use and use extreme caution when disposing of hot grease.
- 08** **⚠ CAUTION** Overfilling may cause a risk of clogging the steam release pipe and developing excess pressure.
- DO NOT fill over the **Max PC Fill** line as indicated on the inner pot.
  - DO NOT fill the inner pot over the **Half Fill** line (as indicated on the inner pot) when cooking foods that expand during cooking such as rice or dried vegetables.
- 09** **⚠ WARNING** This appliance cooks under pressure. Any pressure in the appliance can be hazardous. Allow the appliance to depressurize naturally or release all excess pressure before opening. Inappropriate use may result in burns, injury and/or property damage.
- Make sure the appliance is properly closed before operating. Refer to **Pressure control features: pressure cooking lid**.
  - DO NOT cover or obstruct the steam release valve and/or float valve with cloth or other objects.
  - DO NOT attempt to open the appliance until it has depressurized, and all internal pressure has been released. Attempting to open the appliance while it is still pressurized may lead to sudden release of hot contents and may cause burns or other injuries.

## **⚠ WARNING**

Read this manual carefully and completely and retain for future reference. Failure to adhere to safety instructions may result in serious injury or damage.

# IMPORTANT SAFEGUARDS



- DO NOT place your face, hands or exposed skin over the steam release valve or float valve when the appliance is in operation or has residual pressure.
  - DO NOT lean over the appliance when removing the lid, as heat and steam escape when the lid is removed.
  - Turn the appliance off if steam escapes from the steam release valve and/or float valve in a steady stream during Pre-heating or Cooking, for longer than 3 minutes.
  - If steam escapes from the sides of the lid, turn the appliance off and make sure the sealing ring is properly installed. Refer to Pressure control features: sealing ring.
  - DO NOT attempt to force the lid off the Instant Pot multicooker base. Refer to **Releasing pressure**.
- 10 When cooking meat with skin (e.g. sausage with casing), the skin can swell when heated. Do not pierce the skin while it is swollen; this could result in scalding injury.
- 11 When pressure cooking food with a doughy or thick texture, or a high fat/oil content, contents may splatter when opening the lid. Follow recipe instructions for pressure release method. Refer to **Releasing pressure**.
- 12 Oversized foods and/or metal utensils must not be inserted into the inner pot as they may cause risk of fire and/or personal injury.
- 13 Proper maintenance is recommended before and after each use:
- Check the steam release valve, steam release pipe, anti-block shield and float valve for clogging;
  - Before inserting the inner pot into the multicooker base, make sure both parts are dry and free of food debris;
  - Let the appliance cool to room temperature before cleaning or storage.
- 14 Do not use this appliance for deep frying or pressure frying with oil.
- 15 To disconnect, select **Cancel**, then remove plug from power source. Always unplug when not in use, as well as before adding or removing parts or accessories, and before cleaning. To unplug, grasp the plug and pull from the outlet. Never pull from the power cord.

## WARNING

Read this manual carefully and completely and retain for future reference. Failure to adhere to safety instructions may result in serious injury or damage.

# IMPORTANT SAFEGUARDS



- 16 Regularly inspect the appliance and power cord. Do not operate the appliance if the power cord or plug is damaged, or after the appliance malfunctions or is dropped or damaged in any manner. For assistance, contact Customer Care by **email**, **chat**, or by phone at **1-800-828-7280**.
- 17 Spilled food can cause serious burns. A short power-supply cord is provided to reduce the hazards resulting from grabbing, entanglement and tripping.
  - DO NOT let the power cord hang over edges of tables or counters, or touch hot surfaces or open flame, including the stovetop.
  - DO NOT use below-counter power outlets, and never use with an extension cord.
  - Keep the appliance and cord away from children.
- 18 Do not use any accessories or attachments not authorized by Instant Brands Inc. The use of parts, accessories or attachments not recommended by the manufacturer may cause a risk of injury, fire or electric shock.
  - To reduce the risk of pressure leakage, cook only in an authorized stainless-steel Instant Pot inner pot made for this model.
  - DO NOT use the appliance without the removable inner pot installed.
  - To prevent personal injury and damage to the appliance, only replace the sealing ring with an authorized Instant Pot sealing ring.
- 19 DO NOT attempt to repair, replace or modify components of the appliance, as this may cause electric shock, fire or injury, and will void the warranty.
- 20 Do not tamper with any of the safety mechanisms, as this may result in injury or property damage.
- 21 The multicooker base contains electrical components. To avoid electrical shock:
  - DO NOT put liquid of any kind into multicooker base;
  - DO NOT immerse power cord, plug or the appliance in water or other liquid;
  - DO NOT rinse the appliance under tap.

## WARNING

Read this manual carefully and completely and retain for future reference. Failure to adhere to safety instructions may result in serious injury or damage.

# IMPORTANT SAFEGUARDS



- 22 Do not use the appliance in electrical systems other than 120 V ~ 60 Hz for North America. Do not use with power converters or adapters.
- 23 This appliance is NOT to be used by children or by persons with reduced physical, sensory or mental capabilities. Close supervision is necessary when any appliance is used near children and these individuals. Children should not play with this appliance.
- 24 Do not leave the appliance unattended while in use. **Never connect this appliance to an external timer switch or separate remote-control system.**
- 25 Do not store any materials in the multicooker base or inner pot when not in use.
- 26 Do not place any combustible materials in the multicooker base or inner pot, such as paper, cardboard, plastic, Styrofoam or wood.
- 27 Do not use the included accessories in a microwave, toaster oven, **convection or conventional oven, or on a ceramic cooktop, electric coil, gas range or outdoor grill.**

## SAVE THESE INSTRUCTIONS.

### WARNING

To avoid injury, read and understand the instructions in this user manual before attempting to use this appliance.

### WARNING

Electrical shock hazard. Use grounded outlet only.

- DO NOT remove ground.
- DO NOT use an adapter.
- DO NOT use an extension cord.

Failure to follow these instructions may result in electric shock and/or serious injury.

### WARNING

THE FAILURE TO FOLLOW ANY OF THE IMPORTANT SAFEGUARDS AND/OR THE INSTRUCTIONS FOR SAFE USE IS A MISUSE OF YOUR APPLIANCE THAT CAN VOID YOUR WARRANTY AND CREATE THE RISK OF SERIOUS INJURY.

### WARNING

Read this manual carefully and completely and retain for future reference. Failure to adhere to safety instructions may result in serious injury or damage.

# IMPORTANT SAFEGUARDS



## Special cord set instructions

Per safety requirement, a short power supply cord is provided to reduce the hazards resulting from entanglement and tripping.

This appliance has a 3-prong grounding plug. To reduce the risk of electric shock, plug the power cord into a grounded electrical outlet that is easily accessible.

## Product specifications

Model: Pro Plus 60	1200 W	120 V ~ 60 Hz	6 Quarts / 5.7 Litres	15 lb / 6.8 kg

	Pro Plus 60
	in: 15.04L x 15.04W x 15.28H cm: 38.2L x 38.2W x 38.8H

## Find your model name and serial number

Find the **model name** on the silver rating label on the back of the multicooker base, near the power cord. The **serial number** is located on a white sticker beside the rating label.

### WARNING

Read this manual carefully and completely and retain for future reference. Failure to adhere to safety instructions may result in serious injury or damage.

# Table of contents

<b>IMPORTANT SAFEGUARDS</b> .....	<b>2</b>
Special cord set instructions.....	7
Product specifications .....	7
Find your model name and serial number .....	7
<b>Product, parts and accessories</b> .....	<b>10</b>
<b>Get started</b> .....	<b>12</b>
Initial set up.....	12
Initial test run (water test).....	13
<b>Pressure cooking 101</b> .....	<b>15</b>
<b>Releasing pressure</b> .....	<b>16</b>
Venting methods.....	16
<b>Releasing pressure</b> .....	<b>17</b>
<b>Control panel</b> .....	<b>18</b>
Cooking progress bar .....	20
Status messages.....	21
Settings.....	22
<b>Wifi pairing</b> .....	<b>23</b>
<b>Pressure control features</b> .....	<b>24</b>
Pressure cooking lid .....	24
QuickCool™ .....	25
Steam release assembly.....	26
Anti-block shield .....	27
Sealing ring.....	27
Float valve .....	28
<b>Canning 101</b> .....	<b>29</b>
Sterilizing jars for canning .....	29
Filling jars for canning .....	30



# Table of contents

<b>Cooking</b> .....	<b>31</b>
Steam .....	35
Sauté .....	37
Deglazing .....	38
Yogurt .....	38
Using yogurt cups.....	40
Sous Vide .....	41
Reverse Searing.....	42
Ingredients and Seasonings.....	42
Keep Warm .....	43
<b>Care, cleaning and storage</b> .....	<b>44</b>
Removing and installing parts.....	46
<b>Troubleshooting</b> .....	<b>49</b>
<b>Warranty</b> .....	<b>52</b>

# Product, parts and accessories

Before using your new Instant Pot Pro Plus, make sure everything is accounted for, then see **Care, cleaning and storage: Removing and installing parts** to find out how everything fits together.

## Top of lid

### Steam release assembly

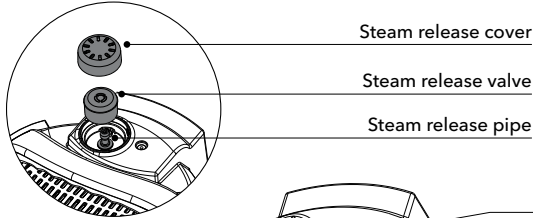

Lid fin  
Lid handle

QuickCool™ protective cover

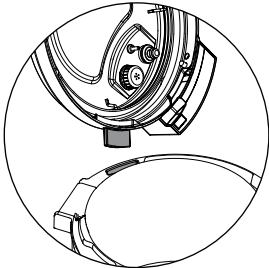
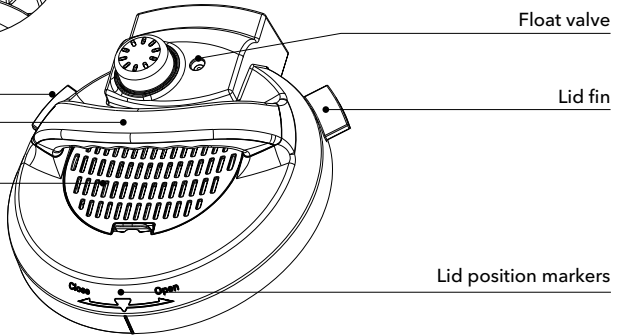

💡 Instant Tip: Stand the pressure cooking lid up to keep it off your countertop. Insert the left or right lid fin into corresponding lid holders on the base to stand it up and save some space!

## Bottom of lid

Sealing ring

Sealing ring rack

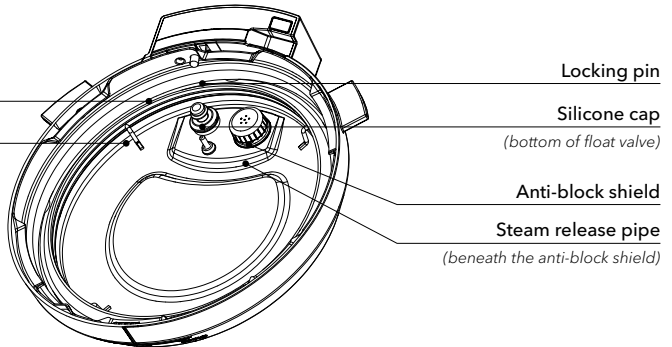

*Illustrations in this document are for reference only and may differ from the actual product. Always refer to the actual product.*

# Product, parts and accessories

## Inner pot

Easy-grip silicone handles

Fill line indicators

Flat bottom

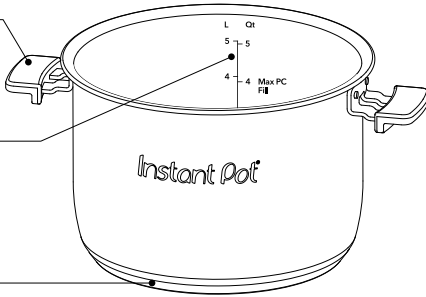

Instant Tip: Stove top and oven-friendly up to 400°F! The inner pot features a cookware-grade impact bonded tri-ply bottom, which sounds complicated, but really just means you can use it just about anywhere – from the multicooker base to any electric, ceramic, gas or induction cooktop.

## Multicooker base

Outer pot

Condensation rim

Control panel

Stainless-steel exterior

Lid holder

Condensation collector (rear)

Multicooker handle

Heating element (interior)

Cord holder (rear)

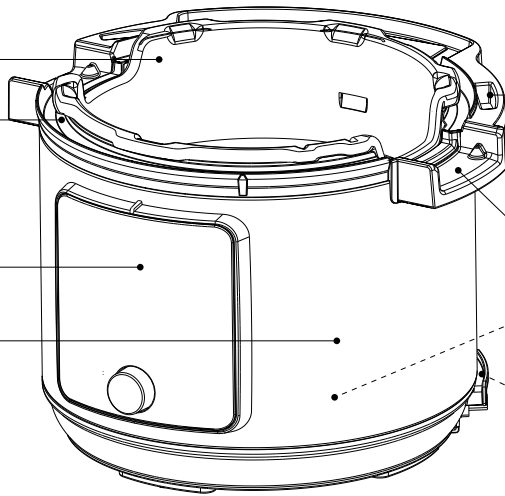

## Accessories

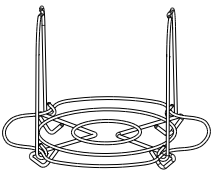

Steam rack

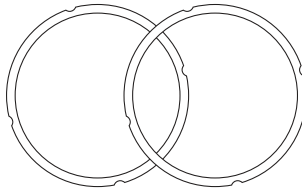

Extra sealing ring

*Illustrations in this document are for reference only and may differ from the actual product. Always refer to the actual product.*



# Get started

## Initial set up

(It won't bite!)

You – yes, you – can do this!

 ***“The only real stumbling block is fear of failure. In cooking you’ve got to have a what-the-hell attitude.” – Julia Child***

- 01** Pull that Instant Pot Pro Plus out of the box!
- 02** Remove the packaging material and accessories from in and around the multicooker and make sure all the parts are accounted for. See **Product, parts and accessories** for a full parts breakdown.
-  Make sure to check under the inner pot!
- 03** Wash the inner pot in a dishwasher or with hot water and dish soap. Rinse it well with warm, clear water and use a soft cloth to thoroughly dry the outside of the inner pot.
- 04** Wipe the heating element with a soft, dry cloth to make sure there are no stray packaging particles left in the multicooker base.
-  Don't remove the safety warning stickers from the lid (unless specified on the sticker!) or the labels from the back of the multicooker base.
- 05** You may be tempted to put the Pro Plus on your stovetop – *but don't do it!* Place the multicooker base on a stable, level surface, away from combustible material and external heat sources.

## Is something missing or damaged?

Get in touch with a Customer Care Advisor through our chat widget at [instantpot.com/#chat](https://instantpot.com/#chat), by email at [support@instantpot.com](mailto:support@instantpot.com) or by phone at **1-800-828-7280** and we'll happily make some magic happen for you!

Feeling keen?

- While you're doing the **Initial test run (water test)**, read over **Pressure cooking 101** to find out how the magic happens, and read through **Pressure control features** for an in-depth look.

### CAUTION

Read the <b>Important safeguards</b> before using the appliance. Failure to read and follow those instructions for safe use may result in damage to the appliance, property damage or personal injury.	Do not place the appliance on a stovetop or upon another appliance. Heat from an external source will damage the appliance.	To avoid risk of property damage and/or personal injury, do not place anything on top of the appliance, and do not cover or block the steam release assembly or anti-block shield, located on the appliance lid.
--	---	--

# Get started

## Initial test run (water test)

Do you *have* to do the water test? No – but getting to know the ins and outs of your new Pro Plus prepares you for success in the kitchen! Take a few minutes to get to know how this tireless kitchen hero works.

### Stage 1: Setting up the Pro Plus for pressure cooking

**01** Remove the inner pot from the multicooker base and fill it to the first line (**1**) with water.

**02** Insert the inner pot into the multicooker base.

**03** Connect the power cord to a 120 V power source.

The display shows **OFF**.

**04** Place and close the lid as described in **Pressure control features: pressure cooking lid**.

 The lid automatically seals for pressure cooking.

**Stage 2: “Cooking” (...but not really, this is just a test!)**

**05** Touch **Pressure Cook**.

**06** When the **minutes field** flashes, turn the dial to adjust the cook time to 5 minutes (**00:05**).

 Customizations are saved to the Smart Program when cooking begins.

**07** Touch the **Venting field** to toggle between **Natural**, **Pulse** and **Quick release** options.

Select **Quick** for a quick pressure release after the test finishes.

See **Releasing pressure** for more information.

**08** Touch **Keep Warm** to turn automatic warming off after the test finishes.

**09** Touch **Start** to begin.

The display shows **On** and the cooking progress bar shows **Pre-heating**.

 While the multicooker does its thing, read **Pressure cooking 101** to find out how the magic happens.

### Stage 3: Releasing pressure

**10** When the Smart Program finishes, the display shows **End**.

The Pro Plus releases a short warning burst of steam from the steam release valve, followed by a continuous stream of steam.

**11** Once the float valve drops, check the **pressure indicator** on the control panel to make sure the lid is safe to open, then carefully open and remove the lid as described in **Pressure control features: Pressure cooking lid**.



**12** Using proper hand protection, remove the inner pot from the multicooker base, discard the water and thoroughly dry the inner pot.

**That's it! You're good to go :)**

# Get started

## CAUTION

Pressurized steam releases through the top of the steam release valve. Keep exposed skin away from the steam release valve to avoid burn injury.

## DANGER

**DO NOT attempt to remove the lid while the float valve is up and NEVER attempt to force the lid open.** Contents are under extreme pressure. Float valve must be down before attempting to remove the lid. Failure to follow these instructions may result in serious personal injury and/or property damage

## CAUTION

The inner pot will be hot after cooking. Always use appropriate heat protection when handling a hot inner pot to avoid burn injury.

# Pressure cooking 101

## (Behind the magic curtain)

Pressure cooking uses steam to raise the boiling point of water above 100°C / 212°F. These high temperatures allow you to cook food way faster than normal.

When pressure cooking, the Instant Pot Pro Plus goes through 3 stages.

### Pre-heating

What you see	What you don't see	Tips
The cooking progress bar shows <b>Pre-heating</b> .  The display shows <b>On</b> .	While the multicooker pre-heats, it vaporizes liquid to create steam.  Once enough steam has built up, the float valve pops up and locks the lid in place.	The time it takes the multicooker to pressurize depends on things like food and liquid temperature and volume.  Frozen foods have the longest pre-heating time. For the fastest results, thaw your food before cooking it.  No need to hang around during this stage – trust that IP magic!

### Cooking

What you see	What you don't see	Tips
The cooking progress bar moves over to <b>Cooking</b> .  The display switches to the cooking countdown timer.	When the Instant Pot reaches the required pressure level, cooking begins. The Instant Pot Pro Plus automatically maintains at <b>Low</b> , <b>High</b> , or <b>Max</b> pressure throughout cooking.	A higher pressure means a higher temperature.  Smart Program settings (e.g., cooking time, pressure level, etc.) can be adjusted at any time during cooking.

### Depressurization

What you see	What you don't see	Tips
If Keep Warm is on after cooking, the cooking progress bar moves over to <b>Keep Warm</b> , and the timer counts up from <b>00:00</b> .  If not, the multicooker returns to standby and displays <b>End</b> .	Although food has finished cooking, the multicooker is still pressurized and hot.	Follow your recipe instructions when choosing a venting method.  Venting lowers the temperature and allows you to safely remove the lid.  See <b>Releasing pressure: Venting methods</b> on the next page for information on safe venting techniques.

# Releasing pressure

You **must** release pressure after pressure cooking before attempting to open the lid. Follow your recipe's instructions to choose a venting method.

## ⚠ WARNING

Steam ejected from the steam release valve is hot. **DO NOT** place hands, face, or any exposed skin over the steam release assembly when releasing pressure to avoid injury.

Do not cover or obstruct the steam release valve or cover to avoid injury and/or property damage.

## ⚠ DANGER

**DO NOT attempt to remove the lid while the float valve is up and NEVER attempt to force the lid open.** Contents are under extreme pressure. Float valve must be down before attempting to remove the lid. Failure to follow these instructions may result in serious personal injury and/or property damage.

## Venting methods

### Natural release (NR or NPR)

After the cooking finishes, the temperature within the multicooker drops gradually and the multicooker depressurizes naturally over time.

#### What to do

Touch the **Venting field** on the control panel to toggle to **Natural**.

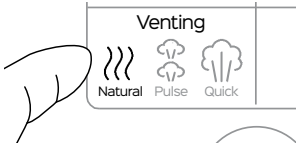

#### What to expect

When cooking finishes, the multicooker does not vent, so your meal continues to cook even after the Smart Program ends.



Instant Tip: This is called "carryover cooking" or "resting", and it's great for large cuts of meat.

The depressurization time may vary based upon the volume, type and temperature of food and liquid. It can take up to 40 minutes with some dishes, so plan ahead – it's well worth the wait!

When pressure has been fully released, the float valve drops into the lid and the pressure indicator light dims.

## NOTICE

Use NR to depressurize the multicooker after cooking high-starch foods (e.g., soups, stews, chilis, pasta, oatmeal and congee) or after cooking foods that expand when cooked (e.g., beans and grains).



# Releasing pressure

## Quick Release (QR or QPR)

When cooking finishes, a quick release drops the pressure and temperature quickly to prevent overcooking. Perfect for quick-cooking vegetables and delicate seafood!

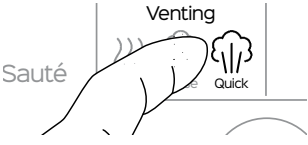
What to do	What to expect
<p>Touch the <b>Venting field</b> on the control panel to toggle to <b>Quick</b>.</p>  <p>The diagram shows a hand touching the 'Venting' field on the control panel. The panel has three fields: 'Sauté', 'Venting', and 'Quick'. The 'Venting' field is currently selected, indicated by a cloud icon. The 'Quick' field is also visible with a cloud icon.</p>	<p>When cooking finishes, the Pro Plus releases a warning puff, followed by a steady stream of steam from the top of the steam release valve.</p> <p><b>This is normal!</b></p> <p>When pressure has been fully released, the float valve drops into the lid and the pressure indicator light dims.</p>

## NOTICE

Do not use QR when cooking fatty, oily, thick or high-starch foods (e.g., stews, chilis, pasta and congee) or when cooking foods that expand when cooked (e.g., beans and grains).

If you see a lot of spatter while releasing pressure, touch the **Venting field** to return to **Natural**, then touch **Start**. Wait a few minutes before trying to release pressure again. If spatter continues, use NR to safely release the remaining pressure. Quick Release (QR or QPR)

## Pulse release

When cooking completes, the Pro Plus releases timed bursts of steam to release pressure – perfect for rice, grains, and much more.

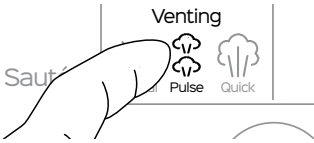
What to do	What to expect
<p>Touch the <b>Venting field</b> on the control panel to toggle to <b>Pulse</b>.</p>  <p>The diagram shows a hand touching the 'Venting' field on the control panel. The panel has three fields: 'Sauté', 'Venting', and 'Quick'. The 'Venting' field is currently selected, indicated by a cloud icon. The 'Pulse' field is also visible with a cloud icon.</p>	<p>When cooking finishes, the multicooker releases a short burst of steam every 15 seconds.</p> <p>When pressure has been fully released, the float valve drops into the lid and the pressure indicator light dims.</p>

# Control panel



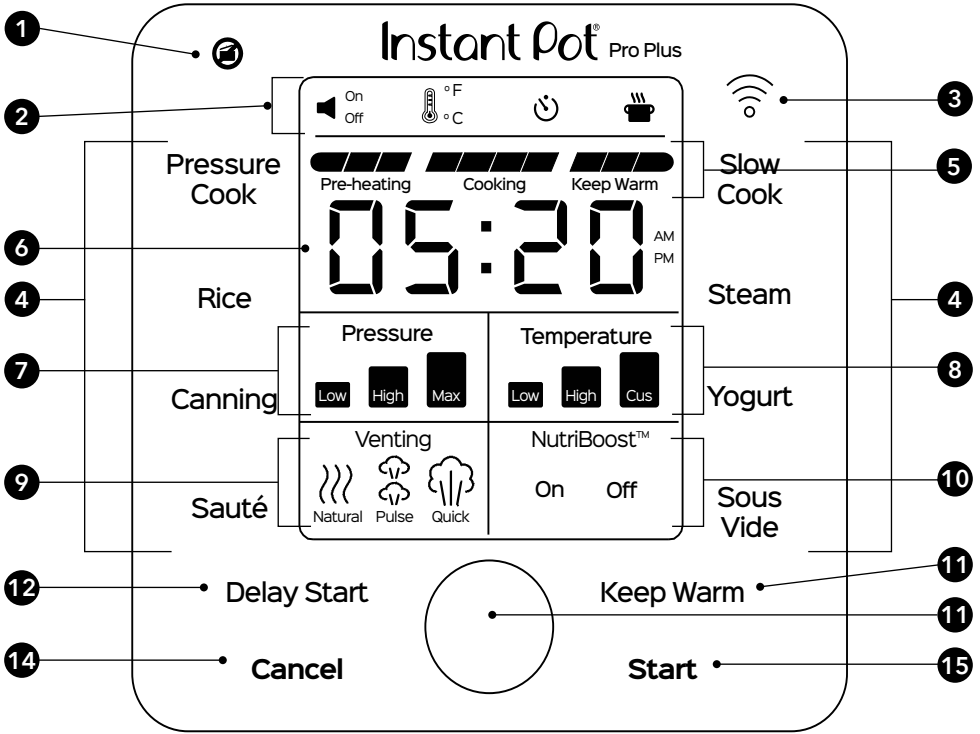

The Pro Plus has a touch screen control panel that's easy to use and understand.



1	<b>Pressure indicator</b>	Lights up when there is pressure in the multicooker to show that the lid is locked and cannot be removed.	
2	<b>Status icons</b>		Shows if sounds are <b>On</b> or <b>Off</b> , as indicated.
			Delay Start is running.
			Appears when Keep Warm is running, or is set to turn on after cooking finishes.
			Indicates if the temperature scale is showing in Fahrenheit (°F) or Celsius (°C). See <b>Control panel: Settings</b> for details.
3	<b>WiFi indicator</b>	Lights up when pairing with the Instant Pot App and connected to a device. See <b>WiFi</b> for more information.	

*Illustrations in this document are for reference only and may differ from the actual product. Always refer to the actual product.*

# Control panel

4	Smart Programs	<ul style="list-style-type: none"> <li>• Pressure Cook</li> <li>• Rice</li> <li>• Canning</li> <li>• Sauté</li> </ul>	<ul style="list-style-type: none"> <li>• Slow Cook</li> <li>• Steam</li> <li>• Yogurt</li> <li>• Sous Vide</li> </ul>
		See <b>Cooking</b> for details.	
5	Cooking progress bar	Shows when the multicooker is in <b>Pre-heating</b> , <b>Cooking</b> and <b>Keep Warm</b> modes. See <b>Control panel: Cooking progress bar</b> for more information.	
6	Time display	In standby, shows <b>OFF</b> . When connected to the WiFi, it shows a 12-hour <b>AM/PM clock</b> that can be set to local time. In a Smart Program, counts up or down, depending on the program.	
		 Some Smart Programs display the temperature in <b>°C</b> (Celsius) or <b>°F</b> (Fahrenheit).	
7	Pressure	Choose between <b>Low</b> , <b>High</b> , and <b>Max</b> .	
8	Temperature	Choose between <b>Low</b> , <b>High</b> , and <b>Custom</b> .	
9	Venting	Choose between 3 venting methods:	
			<b>Natural</b> release
			<b>Pulse</b> release
			<b>Quick</b> release
10	NutriBoost	Toggles the NutriBoost setting <b>On</b> and <b>Off</b> . See <b>Cooking: NutriBoost</b> for more information.	
11	Control dial	Turn the dial to adjust the time and temperature.	
12	Delay Start	Delay the start of cooking. Doubles as a kitchen timer!	
13	Keep Warm	Turns <b>Keep Warm</b> on or off.	
		 Can only be used with Pressure Cook, Rice, Canning and Slow Cook, or as a standalone program when in standby.	
14	Cancel	Stops a Smart Program at any time and returns the multicooker to standby.	
15	Start	Begins the selected Smart Program.	

# Control panel

## Cooking progress bar

**Pre-heating** is in progress. The display shows **On** during the pre-heating stage to let you know that it's working on getting up to temperature.



**Cooking** is shown after the Pro Plus reaches the target pressure or temperature required by the Smart Program.



**Keep Warm** comes on automatically after cooking finishes to keep your meal at serving temperatures .

Only applies to Pressure Cook, Rice and Slow Cook.



# Control panel

## Status messages

OFF	The Pro Plus is in standby mode, ready whenever you are.
On	The multicooker is <b>Pre-heating</b> .
Hot	The inner pot has reached the perfect cooking temperature and food can be added.  Only applies to Sauté and Sous Vide.
05:20	Display shows one of the following: <ul style="list-style-type: none"><li>• The remaining <b>Cooking</b> time when a Smart Program is running,</li><li>• The <b>Delay Start</b> countdown,</li><li>• How long food has been in <b>Keep Warm</b>,</li><li>• When connected to WiFi, the <b>local 12-hour time</b> (set by you) appears when the multicooker is in standby.</li></ul>
End	When cooking finishes, the display shows <b>End</b> until you remove the lid or touch <b>Cancel</b> .

Do you see something else? See **Troubleshooting** for more information.

# Control panel

## Settings

Setting	Description				
Turn sound on or off.	When in standby, touch and hold the sound icon for 2 seconds to toggle sounds on and off.  Audible safety and error message alerts cannot be turned off.				
Change displayed temperature (°C and °F).	When in standby, touch and hold the <b>thermometer icon</b> for 2 seconds to toggle between displaying °C and °F.				
Adjust and save custom cooking times and temperatures.	Once a Smart Program is selected, changes to the cooking time, temperature and pressure level are saved once the Smart Program begins.				
Delay the start of cooking.	<table border="1"> <thead> <tr> <th>Default time</th> <th>Time range</th> </tr> </thead> <tbody> <tr> <td>6 hours (06:00)</td> <td>10 minutes to 24 hours (00:10 to 24:00)</td> </tr> </tbody> </table>	Default time	Time range	6 hours (06:00)	10 minutes to 24 hours (00:10 to 24:00)
	Default time	Time range			
6 hours (06:00)	10 minutes to 24 hours (00:10 to 24:00)				
<ol style="list-style-type: none"> <li>Select and set up an applicable Smart Program.</li> <li>When you're ready, touch <b>Delay Start</b>. The <b>hours field</b> flashes.</li> <li>Turn the dial to adjust the <b>hours field</b> as needed.</li> <li>Touch the <b>minutes field</b> to toggle to it. Turn the dial to adjust the <b>minutes field</b> as needed.</li> <li>Press <b>Start</b> to begin the delay countdown.</li> </ol> <p>Delay Start cannot be used with Sauté, Yogurt or Sous Vide.</p>					
Reset an individual Smart Program.	When in standby, touch and hold the Smart Program button you want to reset for 3 seconds . The Smart Program's cooking time, pressure level and/or temperature are restored to the factory default setting.				
Reset all Smart Programs.	When in standby, touch and hold <b>Cancel</b> until the multicooker beeps. All Smart Program cooking times, pressure levels and/or temperatures are restored to factory default settings.				

# Wifi pairing

Use your Pro Plus through your mobile device with the Instant Pot app. To download the app:

- Scan the QR code at the bottom of this page, or;
- Visit [www.instantpot.com/app](http://www.instantpot.com/app), or;
- Search "Instant Pot" in the Apple Store or the Google Play Store.

 **New users are required to create an account.**

## Requirements for WiFi pairing

### Compatible mobile devices:

- Android version **5.0** or later
- iOS version **9.0** or later

The Instant Pot app needs to connect to the Pro Plus multicooker through a 2.4GHz frequency band.

## Follow the steps below to start the pairing process.

 You must be signed into the app to continue the pairing process.

**01** Open the Instant Pot App **and sign into your user account.**

**02** More steps.

**03** More steps.

# Pressure control features (Your little bag of tricks!)

See **Care, cleaning and storage** for installation and removal of parts.

## Pressure cooking lid

When it's plugged in, the Pro Plus plays a little jingle when you open and close the lid.

What we love about it	What you should know about it
<p>When you close the lid, it automatically gets ready to seal for <i>seriously easy</i> pressure cooking.</p> <p>It closes over the handles on the new inner pot.</p> <p>The lid handle is comfortable to use whether you're left or right-handed, and, stands up in the multicooker base!</p>	<p>The lid is removable during non-pressure cooking so you can taste-test as you go.</p> <p>When pressure cooking, the lid only locks into place once the multicooker has pressurized.</p> <p>Try not to remove the lid unnecessarily.</p>

### Removing the lid

- 01** Grip the handle and turn it counter-clockwise to align the ▼ on the lid with the I on the rim of the multicooker base.

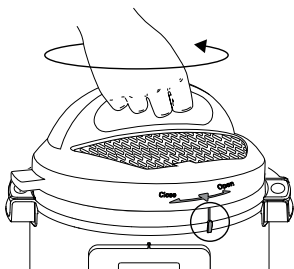

- 02** Lift the lid up and off the multicooker base towards your body.

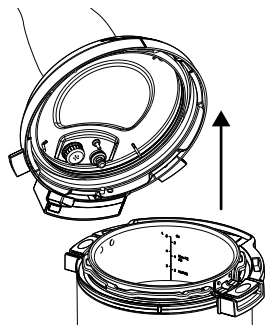

See **Releasing pressure** for safe depressurization techniques.

### Closing the lid

- 01** Align the ▼ on the lid with the I on the multicooker base, then lower the lid onto the track.

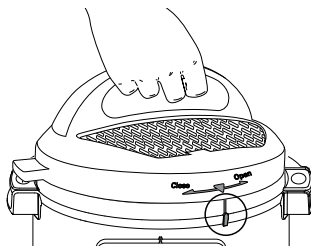

- 02** Turn the lid clockwise until the ▼ on the lid aligns with the middle of the control panel.

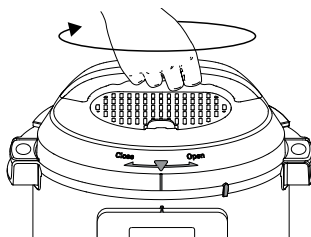



# Pressure control features

## QuickCool™

For the fastest Natural release after pressure cooking, use the QuickCool tray\*.

What we love about it	What you should know about it
It's a huge timer saver – you can release pressure naturally up to 50% faster!	The metal portion of the lid gets <b>extremely hot</b> , so don't remove the protective cover unless you're using QuickCool.

To use the QuickCool tray, fill it with ice or water and freeze it. Once frozen, position the QuickCool tray on the exposed metal of the lid.

When the float valve drops into the lid, remove the QuickCool tray, discard the water, and open the lid.

\*QuickCool tray sold separately at [store.instantpot.com](https://store.instantpot.com).

### CAUTION

The lid will be hot during and after cooking. Do not touch the exposed metal with bare skin to avoid injury.

### CAUTION

The QuickCool tray is not intended to serve food or liquid. To avoid risk of personal injury, do not consume food or liquid from the QuickCool tray.

# Pressure control features

## Steam release assembly

The steam release assembly must be fully installed before use.

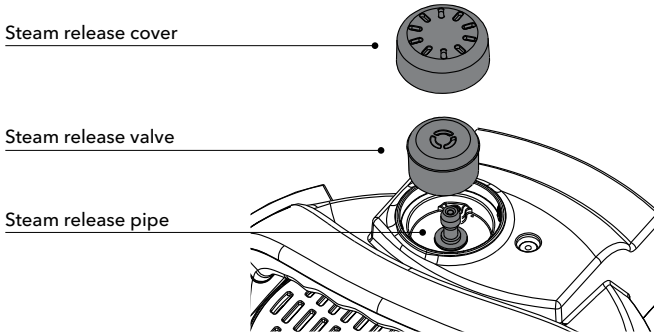

What we love about it	What you should know about it
<p>When the valve's a-venting, the steam release cover disperses the steam, so the quick release of pressure is soft and gentle.</p>	<p>The steam release valve sits loosely on the steam release pipe.</p> <p>When releasing pressure, steam travels up from the inner pot, through the steam release pipe and out from the top of the steam release valve – so it's important to keep the area clean and clear.</p>

### **⚠ WARNING**

Do not cover or block the steam release assembly in any way to avoid injury and/or property damage.

# Pressure control features

## Anti-block shield

The anti-block shield prevents food particles from coming up through the steam release pipe, which assists with pressure regulation.

The anti-block shield is integral to product safety and necessary for pressure cooking, so it must be installed before use.

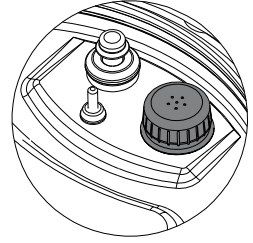



## Sealing ring

When the pressure cooking lid is closed, the sealing ring creates an air-tight seal between the lid and the inner pot.

The sealing ring must be installed before use.

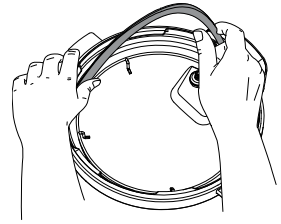
 Only one sealing ring should be installed in the lid at a time.



 **Instant Tip:** Silicone is porous, so it absorbs strong aromas and certain flavors. Keep extra sealing rings on hand to limit the transfer of those aromas and flavors between dishes. Visit our store to start color coding your cooking!

## CAUTION

Always check for cuts, deformation and correct installation before cooking, as sealing rings stretch over time with normal use. If you notice stretching, deformation, or damage to your sealing ring, **DO NOT** use it.

Replace the sealing ring every 12 to 18 months or sooner, and only use authorized Instant Pot sealing rings.

Failure to follow these instructions may cause food to discharge, which may lead to personal injury or property damage.

# Pressure control features

## Float valve

The float valve lets you know when there is pressure in the multicooker (pressurized) or not (depressurized). It appears in 2 positions:

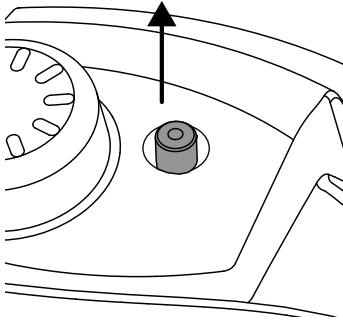

**Pressurized**

The float valve has visibly popped up above the surface of the lid.

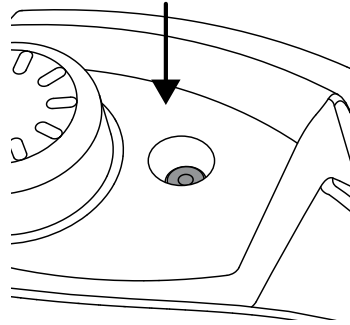

**Depressurized**

The float valve has descended, and the top is flush with the lid.

The float valve and silicone cap work together to seal in pressurized steam. These parts must be installed before use. Do not attempt to operate the Instant Pot without the float valve properly installed. **Do not touch the float valve during use.**

## **⚠ DANGER**

**DO NOT attempt to remove the lid while the float valve is up and NEVER attempt to force the lid open.** Contents are under extreme pressure. Float valve must be down before attempting to remove the lid. Failure to follow these instructions may result in serious personal injury and/or property damage.

# Canning 101

The Canning Smart Program is a pressure cooking function based on traditional canning principles. Following proper canning processes, canning can be an easy, economical way to preserve quality food at home.

The Pro Plus uses 2 pressure canning settings:

<b>Low</b>	Perfect for canning high-acid fruit, including sauces, jams and chutneys.
<b>Max</b>	Store your amazing vegetarian sauces and high-acid vegetables, as well as low-acid foods such as sauces and soups containing meat.

## ⚠ CAUTION

Recipes must be closely followed when canning. Modifying cooking times, ingredients or temperatures can be dangerous. Use the exact time, temperature/pressure and method specified in the recipe to protect the food from harmful bacteria, molds, and enzymes.

Improper canning may cause preserves to spoil, which may result in illness. Do not pressure can at altitudes above 2000m (6600ft).

Read and carefully follow the instructions provided in the USDA's Complete Guide to Home Canning.

## Sterilizing jars for canning

Your preserves must be placed into sterile, empty jars.

## NOTICE

Always check your jars, lids, and seals for chips and other imperfections. Sterilization of jars should occur just before filling. Excess contact with the air should be avoided for safe canning.

- 01** Wash the jars with hot water and dish soap, then rinse them thoroughly.
- 02** Place the inner pot into the cooker base, then lay the steam rack on the bottom of the inner pot.
- 03** Place the jars on the steam rack. The pressure cooker will hold up to 4 x 16 oz. (500 mL) jars.
- 04** Fill the inner pot to the first line (1) with water.
- 05** Follow steps **03** to **07** in **Pressure Cook, Rice** and **Canning** to program the following:
  - a. Pressure level: **Low**
  - b. Time: 10 minutes (**00:10**)
  - c. Venting method: **Quick**
- 06** Touch **Start** to begin sterilization.

# Canning 101

## Filling jars for canning

Choose a recipe that has been pre-tested and approved for pressure canning. Though ingredients may vary, the process will be the same!

Refer to the **USDA's Complete Guide to Home Canning** for tested recipes.

- 01** Fill warm, sterilized canning jars with food and liquid.

Follow your recipe to allow for the required headspace.

- 02** Use a sterilized, flexible, nonporous spatula, to remove trapped air bubbles.

- 03** Place a sterilized lid on top of the jar, then add a screw band. Hand-tighten the band. **Do not over-tighten.**

Place the filled and sealed jars on the steam rack in the inner pot.



Instant Tip: The multicooker will hold up to 4 x 16 oz. jars.

- 04** Pour hot water into the inner pot until the jars are  $\frac{1}{4}$  of the way immersed (approximately 6 cups [1½ L / 48 oz]).

- 05** Follow the steps in **Cooking: Pressure Cook, Rice and Canning** (starting at step 02) to set the appropriate canning time and pressure levels for your recipe.

# Cooking

The Instant Pot Pro Plus is amazingly versatile in the kitchen. No matter what kind of cooking you want to do, the Pro Plus has your back.

If you need to make changes to the cooking time, pressure level or temperature after a program has started, just touch the related field, customize the Smart Program as you like, then touch **Start!**

## CAUTION

Always inspect the lid and inner pot carefully to make sure they are clean and in good working condition before use.

- To avoid personal injury or damage to the appliance, replace the inner pot if it is dented, deformed, or damaged.
- Use only authorized Instant Pot inner pots made for this model when cooking.

Always make sure the heating element is clean and dry before inserting the inner pot into the multicooker base.

Failure to follow these instructions may damage the multicooker. Replace damaged parts to make sure safe function.

## WARNING

DO NOT fill inner pot higher than the **Max PC Fill** line as indicated on the inner pot.

When cooking foods that expand (e.g., rice, beans, pasta) do not fill the inner pot higher than the **Half Fill** line as indicated on the inner pot.

Always cook with the inner pot in place. DO NOT pour food or liquid into the multicooker base.

To avoid risk of personal injury and/or property damage, place food and liquid ingredients in the inner pot, then insert the inner pot into the multicooker base.

## CAUTION

When cooking meat, always use a meat thermometer to ensure the internal temperature reaches a safe minimum temperature. Refer to the **USDA's Safe Minimum Internal Temperature Chart** or Health Canada's **Cooking Temperatures Chart** for more information.

# Cooking

## Pressure Cook, Rice and Canning

Jump start magic! These programs use pressurized steam to cook food quickly, evenly, and deeply, for delicious results every time!

For the best pressure cooking results, always follow an authorized Instant Pot recipe or our tried, tested and true pressure cooking timetables which feature grain-to-water ratios for making a variety of rice and grains.

Choose from 3 pressure levels, depending on the Smart Program.

Pressure level	Suggested use	Notes
<b>Low</b> 5.8 - 7.2 psi (30 - 50 kPa)	Fish and seafood, soft vegetables and rice. Also for canning of high-acid foods.	When pressure cooking, the pressure level controls the cooking temperature, so a higher pressure results in a higher cooking temperature.
<b>High</b> 10.2 - 11.6 psi (70 - 90 kPa)	Eggs, meat, poultry, root vegetables, oats, beans, grains, bone broth, stew, chili.	
<b>Max</b> (15 psi) (105 kPa)	Canning of low-acid foods, tough cuts of meat and for flavorful broths.	

Pressure cooking liquids should be water-based, such as broth, stock, soup or juice. If using canned, condensed or cream-based soup, add liquid as directed below.

Instant Pot size	Minimum liquid for pressure cooking*
<b>6 Quarts / 5.7 Litres</b>	1 ½ cups (~12 oz / 375 mL)

\*Unless otherwise specified in recipe.

 Instant Tip: Use the multi-functional rack to heat food evenly, prevent nutrients from leeching into the cooking liquid, allow oil and grease to drip off the food, and, prevent food from scorching the bottom of the inner pot.

### CAUTION



To avoid scorching or scalding injury, be cautious when pressure cooking with more than 1/4 cup (~2 oz / 60 mL) oil, oil-based sauces, condensed cream-based soups, and thick sauces. Add suitable liquid to thin sauces. Avoid recipes that call for more than 1/4 cup (~2 oz / 60 mL) of oil or fat content.



# Cooking

## Pressure Cook, Rice and Canning

Smart program	Default cooking time	Default time range	Default pressure	Pressure levels available
Pressure Cook	10 minutes (00:10)	1 minute to 4 hours (00:01 to 04:00)	High	Low High Max
Rice	12 minutes (00:12)	1 minute to 1 hour (00:01 to 01:00)	Low	Low High
Canning	30 minutes (00:30)	1 minute to 4 hours (00:01 to 04:00)	Max	Low Max

- 01 Add food and liquid to the inner pot as indicated in your recipe.
- 02 Insert the inner pot into the multicooker base.
- 03 Place and close the pressure cooking lid as described in **Pressure control features: Pressure cooking lid**.
- 04 Touch the Smart Program you want to use: **Pressure Cook**, **Rice** or **Canning**.
- 05 Touch the **hours field** or the **minutes field**, then turn the dial to adjust the cooking time in hours and/or minutes.  
 The hours field is disabled in Rice.
- 06 Touch the **Pressure field** to toggle between available **Low**, **High**, and **Max** pressure levels.
- 07 Touch the **Venting field** to toggle between **Natural**, **Pulse** and **Quick** release options.
- 08 Touch **Start** to begin.  
The display shows **On** and the cooking progress bar shows Pre-heating.  
 Read **Pressure Cooking 101** to get a glimpse behind the curtain and find out what's going on in that big ol' magic pot.
- 09 When the Smart Program finishes the display shows **End** if Keep Warm is turned off. If not, the timer begins counting from **00:00** up to 10 hours (**10:00**).

Keep Warm comes on automatically. If you don't want the Pro Plus to Keep Warm after cooking, press **Keep Warm** to turn it off any time.

A delay start timer can be set to automatically start pressure cooking while you're in bed, working, running errands or busy with other dishes. To set a delay start timer, see **Control panel: Settings**.

# Cooking

## NutriBoost™

NutriBoost is a mid-cooking Pulse release setting that can be activated during the Pressure Cook and Rice Smart Programs. The boiling motion effect helps to break down food, which adds nutrients, enhances flavors, and improves textures. Amazing for rich bone broth and creamy risotto!

NutriBoost is super easy to use – just touch the **NutriBoost field** to turn it **On** and **Off**, as you like.

Smart Program	What you should know about it
Pressure Cook	The multicooker will release puffs of steam during the first 3 minutes of the <b>Cooking</b> stage.
Rice	The multicooker will release puffs of steam during the last 15 minutes of the <b>Cooking</b> stage.

### CAUTION

To avoid spatter and food ejection, do not use NutriBoost when cooking starchy or foamy food like porridge, oatmeal, or pasta. The multicooker should be closely monitored when using NutriBoost.

# Cooking

## Steam

The Steam program works like a regular stovetop steamer, boiling liquid in the inner pot to cook food with hot steam. When steaming, use the multi-functional rack to keep food out of the boiling liquid.

Smart Program	Default time	Time range	Default temperature
Steam	10 minutes (00:10)	1 minute to 1 hour (00:01 to 01:00)	100°C / 212°F Not adjustable.

### **⚠ CAUTION**

The inner pot and accessories will be hot during and after cooking. Always use appropriate hand protection when adding to or removing food from a hot inner pot to avoid injury and/or property damage.

### **NOTICE**

The float valve should not rise during Steam. The lid is removable throughout the cooking process for easy access. If the float valve rises, touch the **Venting field**, then toggle to **Quick** and touch **Start**.

### **NOTICE**

If there is steam in the inner pot, you may notice some resistance when re-placing the lid. Allow the lid to settle into the track completely before closing it.

- 01** Add water to the inner pot.
- 02** Insert the inner pot into the multicooker base.
- 03** Place and close the pressure cooking lid as described in **Pressure control features: Pressure cooking lid**.
- 04** Touch **Steam**.
- 05** Turn the dial to adjust the cooking time.
- 06** Press **Start** to begin.  
The display shows **On** and the cooking progress bar shows **Pre-heating**.
- 07** When the Pro Plus reaches the target temperature, the progress bar moves over to **Cooking** and the timer counts down.
- 08** When the Smart Program finishes the display shows **End**.

Automatic Keep Warm cannot be used with Steam.

A delay start timer can be set to automatically start steaming while you're in bed, working, running errands or busy with other dishes. To set a delay start timer, see

**Control panel: Settings.**

# Cooking

## Slow Cook

The Slow Cook program is comparable to a traditional slow cooker, so you can keep using all your old family favorites!

Cooking time range	Temperature level	Suggested use	Notes
30 minutes to 24 hours (00:30 to 24:00)	Low	For that low and slow, all-day kind of cooking.	You can use the pressure cooking lid, or, if you want to watch your food while it cooks, any glass lid with a venting hole will do.
	High	Slow cooking, but a little bit faster.	Dishes should cook for at least 3 hours (03:00) unless otherwise stated in your recipe.

The float valve should not rise during Slow Cook. The lid is removable throughout the cooking process for easy access. If the float valve rises, touch the **Venting field** to toggle to **Quick**. See **Releasing pressure** for safe venting techniques.

- 01 Add food and liquid ingredients to the inner pot according to your recipe.
- 02 Insert the inner pot into the multicooker base.
- 03 Place and close the pressure cooking lid as described in **Pressure control features: Pressure cooking lid**.
- 04 Touch **Slow Cook**.
- 05 Touch the **hours field** or the **minutes field**, then turn the dial to adjust the cooking time in hours and/or minutes.
- 06 Touch the **Temperature field** to toggle between **High** and **Low** temperatures.
- 07 Press **Start** to begin.  
The progress bar shows **Pre-heating** and the timer starts counting down immediately.
- 08 When the Pro Plus reaches the target temperature the progress bar moves over to **Cooking**.
- 09 When the Smart Program finishes the display shows **End** if Keep Warm is turned off. If not, the timer begins counting from **00:00** up to 10 hours (**10:00**).

Keep Warm feature comes on automatically after Slow Cook finishes. If you don't want the Pro Plus to Keep Warm automatically, press **Keep Warm** to turn it off any time.

A delay start timer can be set to automatically start slow cooking while you're in bed, working, running errands or busy with other dishes. To set a delay start timer, see **Control panel: Settings**.

# Cooking

## Sauté

Like using a frying pan, griddle or flat-top grill, use Sauté to simmer, reduce and thicken liquids, stir-fry meals, and to caramelize vegetables and sear meat before or after using other cooking methods.

 Instant Tip: If you prefer, you can use the inner pot on any electric, ceramic, gas and induction cooktop. The silicone-grip handles make it easy to hold on to and stir without slipping!

Default time	Time range	Default temperature	Temperature range
30 minutes (00:30)	1 minute to 1 hour (00:01 to 01:00)	High	High Low Custom: Levels 1 to 6

- 01 Insert the inner pot into the multicooker base. **Do not use a lid.**
- 02 Touch **Sauté**.
- 03 Turn the dial to adjust the cooking time.
- 04 Touch the **Temperature field** to toggle between **Low**, **High** and **Custom** temperatures. To set a custom temperature, turn the dial to select your preferred temperature level. There are 6 levels of custom temperatures to choose from, shown as **LE 1** (the lowest temperature) through **LE 6** (the highest temperature). These levels are similar to the temperature levels on your stovetop.
- 05 Touch **Start** to begin.  
The display shows **On** and the cooking progress bar shows **Pre-heating**.
- 06 When the Pro Plus reaches the target temperature the progress bar moves over to **Cooking** and the display shows **Hot** for a few moments before switching over to the countdown timer.
- 07 Add ingredients to the inner pot.  
 If your food ingredients are added before the inner pot has reached the target temperature, the Hot message may not appear. This is normal.
- 08 If the ingredients are finished cooking before the time runs out, touch **Cancel** to end the Smart Program, otherwise, when the Smart Program finishes the display shows **End**.

Delay Start and automatic Keep Warm cannot be used with Sauté.

# Cooking

## Deglazing

Sautéing meat and vegetables before pressure cooking is the perfect way to boost flavors, as sugars caramelize from the high heat of the Sauté Smart Program. Deglazing the inner pot lets you unlock those flavors in amazing sauces, gravies and more.

To deglaze, remove food items from the inner pot and add a thin liquid, like water, broth or wine to the hot surface. Use a wooden or silicone scraper to lift up any food stuck to the bottom of the inner pot and stir it into the liquid.

### CAUTION

The Sauté Smart Program reaches high temperatures. If left unmonitored, food may burn on this setting. **DO NOT** use a lid and **DO NOT** leave the multicooker unattended while using Sauté.

## Yogurt

Made for easy fermented dairy and non-dairy yogurt recipes that you can make again and again.

Instant Pot size	Minimum milk volume	Maximum milk volume
6 Quarts / 5.7 Litres	4 cups (32 oz / 1000 mL)	~4 quarts (128 oz / 3.8 L)

Temperature level	Temperature range	Default time	Time range	Suggested use
Low	Not adjustable	8 hours (08:00)	30 minutes to 99 hours and 30 minutes (00:30 to 99:30)	Fermentation
High	Not adjustable	<b>boil</b>	Not adjustable	Pasteurization
Custom Default: 56°C / 133°F	25 to 85°C 77 to 185°F	8 hours (08:00)	30 minutes to 99 hours and 30 minutes (00:30 to 99:30)	Non-dairy fermentation

# Cooking

Starting with...	Do this!
Pasteurized or unpasteurized milk	Follow all the steps below
Ultra-pasteurized milk	Skip to <b>Step 2: Add starter culture</b> . This is the “cold start” method of yogurt making.

What You'll Need:

- Food Thermometer
- Milk or a non-dairy alternative
- Active yogurt culture

## Step 1: Pasteurize milk

**01** Add milk or milk alternative to the inner pot, and any other ingredients that your recipe calls for.

**02** Place and close the pressure cooking lid as described in **Pressure control features: Pressure cooking lid**.

**03** Touch **Yogurt**.

**04** Touch the **Temperature field** to toggle to **High**.

 The pasteurization time and temperature are preset and cannot be adjusted.

**05** Press **Start** to begin.

The display shows **boil** and the progress bar shows **Pre-heating**.

**06** The display shows **End** when pasteurization is complete.

 Milk must reach a minimum of 72°C / 161°F to pasteurize properly. Use a thermometer to check the temperature.

## Step 2: Add starter culture

**01** Using a thermometer, allow the milk to cool to just below 43°C / 110°F.

**02** Add your starter culture to the milk according to the instructions included with the starter culture product.

 Plain yogurt with active cultures can be used as a starter. Follow a trusted Instant Pot yogurt recipe when using yogurt as a starter culture.

**03** Place and close the pressure cooking lid as described in **Pressure control features: Pressure cooking lid**.

## Step 3: Ferment milk

**01** Touch **Yogurt**.

**02** Touch the **Temperature field** to toggle to **Low**.

To set a custom temperature, touch the **Temperature field** to toggle to **Cus**, then turn the dial to select a temperature.

**03** Touch the **hours field** or the **minutes field**, then turn the dial to adjust the fermentation time in hours and/or minutes.

**04** Touch **Start** to begin. The display shows **On** and the progress bar shows **Pre-heating**.

**05** The display shows **End** when fermentation is complete.

# Cooking

## Tips for yogurt making

- The thicker the milk, the thicker the yogurt!
- For even thicker yogurt, pasteurize your milk twice before fermenting.
- The longer you ferment your milk, the tangier the yogurt will be.
- Use a cheesecloth to strain out liquid whey to get rich Greek-style yogurt.
- Cool your fresh yogurt, then put it in the fridge (covered) for 12 to 24 hours to allow the flavors to develop.
- Honey, nuts, seeds, and fresh fruit are perfect toppers for your homemade yogurt!

## Using yogurt cups

Yogurt cups are a convenient way to portion out yogurt servings.

- 01** After **Step 2: Add started culture**, carefully pour the milk into your yogurt cups and seal them tightly.
- 02** Place the steam rack on the bottom of the inner pot.
- 03** Position the yogurt cups on the rack and add water to the inner pot until the cups are immersed halfway.
- 04** Follow the steps in **Step 3: Ferment yogurt** normally.



# Cooking

## Sous Vide

Sous Vide cooking involves cooking food underwater, in an air-tight, food-safe bag, for a long period of time. Food cooks in its own juices and comes out delicious and unbelievably tender.

### CAUTION

Do not overfill the inner pot to avoid damage to the multicooker. Total contents (water and food pouches) should leave at least 2" (5 cm) of headspace between the water line and the brim of the inner pot.

Default cooking time	Time range	Default temperature	Temperature range
3 hours (03:00)	30 minutes to 99 hours and 30 minutes (00:30 to 99:30)	56°C 133°F	25 to 90°C 77 to 194°F

You'll need:

- Tongs
- Thermometer
- Food safe, airtight, re-sealable food pouches, or,
- Vacuum sealer and food-safe vacuum bags

### Step 1: Set up the sous vide water bath

- 01** Fill the inner pot to the **Half Fill** mark as indicated on your inner pot, then insert it into the multicooker base.
- 02** Place and close the pressure cooking lid as described in **Pressure control features: Pressure cooking lid**.

### Step 2: Setting up the Pro Plus for sous vide cooking

- 03** Touch **Sous Vide**.
- 04** Touch the **hours field** or the **minutes field**, then turn the dial to adjust the cooking time in hours and/or minutes.
- 05** To set a custom temperature, touch the **Temperature field** then turn the dial to adjust the water bath temperature.

- 06** Press **Start** to begin heating the water in the inner pot.

The display shows **On** and the progress bar shows Pre-heating.

### Step 3: Get food ready

- 01** While the water heats, start by seasoning your food as desired. See **Ingredients and seasonings** below for tips!
- 02** When you're ready, separate each serving of food into individual pouches.
- 03** Remove all air from the pouches and seal them tightly.

# Cooking

## Step 4: Cook 'em up!

**01** Once the water bath is ready, the display shows **Hot** for a few moments before switching over to the countdown timer.

**02** Remove the lid and carefully immerse the sealed pouches.

 The food in the pouches should be immersed, so add heated water to the inner pot any time it's needed, but, if you're using a re-sealable bag, make sure the seal stays above the water.

**03** Place and close the pressure cooking lid as described in **Pressure control features: Pressure cooking lid**.

**04** When the Smart Program finishes the display shows **End**. Open the multicooker and use your tongs to carefully remove the pouches from the hot water.

**05** Open the pouches and use a thermometer to check for doneness.

## Reverse Searing

Searing your meat after low and slow cooking is the easiest way to boost those already-delicious flavors through the roof without overcooking. Try reverse searing for tender, juicy meat with a beautiful burnished crust.

**01** After Sous Vide cooking, remove the meat from the cooking pouch and gently pat it dry to remove as much moisture from the exterior of the meat.

 It may seem counterintuitive, but don't skip this step – you'll end up with more flavor and a great-looking finish!

**02** Use the Sauté program to give it a good sear, or use a cast iron pan, browning torch, or a grill – anything hot to lock in that moisture!

**03** Cover your meat with foil and let it rest for 5-20 minutes, depending on the size of the cut.

## Ingredients and Seasonings

- Salt goes a long way when it has nowhere to go, so it's better to use a little less than you normally would, especially with meats, poultry, and fish. If you find it needs more after cooking, it's easy to salt to taste.
- Use high quality, fresh ingredients when cooking sous vide to ensure the best possible flavor, except...
- Use garlic powder rather than raw garlic. Raw garlic can become bitter and overpowering when cooked sous vide. Pure, high-quality garlic powder will give you the best results.

---

 Instant Tip: Don't use garlic salt in place of garlic powder!

# Cooking

## Keep Warm

Perfect to reheat meals or warm food for long periods of time.

Default time	Time range	Default temperature	Temperature range
10 hours (10:00)	10 minutes to 10 hours (00:10 to 10:00)	High	High Low Custom: 25 to 90°C 77 to 194°F

- 01** Touch **Keep Warm**.
- 02** Touch the **hours field** or the **minutes field**, then turn the dial to adjust the warming time in hours and/or minutes.
- 03** Touch the **Temperature field** to toggle between **Low**, **High** and **Custom** temperature levels.  
  
To set a custom temperature, touch the **Temperature field** to toggle to **Cus**, then turn the dial to choose a temperature.
- 04** Touch **Start** to begin. The display shows **On** and the progress bar shows **Pre-heating**.
- 05** When Keep Warm completes, the display shows **End**.

### CAUTION

Thicker foods may prevent even heating, which can lead to spoiled food if left unattended. When cooking thick foods like stew and chili, stir the contents of the inner pot every 40 to 60 minutes to make sure that heat is evenly distributed.

# Care, cleaning and storage

Clean your Instant Pot Pro Plus and its parts after each use. Failure to follow these cleaning instructions may result in catastrophic failure, which may lead to property damage, severe personal injury.

Always unplug your multicooker and let it cool to room temperature before cleaning. Never use metal scouring pads, abrasive powders or harsh chemical detergents on any of the Instant Pot's parts or accessories.

Let all surfaces dry thoroughly before use, and before storage.

Parts	Cleaning methods and instruction
<b>Accessories</b> <ul style="list-style-type: none"><li>• Steam rack</li></ul>	Dishwasher safe if placed on the top rack.
<b>Lid and parts</b> <ul style="list-style-type: none"><li>• Steam release valve</li><li>• Steam release cover</li><li>• Anti-block shield</li><li>• Sealing ring</li><li>• Float valve</li><li>• Silicone cap</li><li>• QuickCool cover</li><li>• Condensation collector</li></ul>	Dishwasher safe if placed on the top rack. Remove all the parts from the lid before cleaning. See <b>Care, cleaning and storage: Removing and installing parts</b> . <ul style="list-style-type: none"><li>• With the steam release valve and anti-block shield removed, clean the interior of the steam release pipe with a pipe cleaner to prevent clogging.</li><li>• To drain water from the lid after dishwashing, grasp the lid handle and hold the lid vertically over a sink, then turn it 360°— like turning a steering wheel.</li><li>• After cleaning and draining, store the lid upside down on the multicooker base to allow it to air dry completely.</li><li>• Store sealing rings in a well-ventilated area to decrease residual odor of flavorful meals. To eliminate odors, add 1 cup (250 mL / ~8 oz) water and 1 cup (250 mL / ~8 oz) white vinegar to the inner pot, then run Pressure Cook for 5 to 10 minutes and QR pressure.</li><li>• Check the condensation collector after each use and empty and clean it as needed. Do not allow food or moisture to sit in the condensation collector, as harmful bacteria may result.</li></ul>
<b>Inner pot</b>	Dishwasher safe. <ul style="list-style-type: none"><li>• Acute hard water staining (rainbow, bluish or white discoloration) may require scrubbing with a sponge dampened with vinegar or a nonabrasive cleanser like Bar Keeper's Friend.</li><li>• For tough or burned food residue, add boiling water and dish soap to the inner pot and let it sit for a few hours for easy cleaning.</li><li>• Make sure all exterior surfaces are dry before placing the inner pot in the multicooker base.</li></ul>
<b>Power cord</b>	Wipe only. <ul style="list-style-type: none"><li>• Use a barely damp cloth to remove particles from the cord.</li><li>• Wrap it around the multicooker base and tuck the end into the cord holder.</li></ul>
<b>Multicooker base</b>	Hand wash only. <ul style="list-style-type: none"><li>• Wipe the inside of the outer pot as well as the condensation rim with a barely damp cloth. Allow them to dry completely before inserting the inner pot.</li><li>• Clean the multicooker base and control panel with a soft, barely damp cloth or sponge.</li></ul>

Some discoloration may occur after machine washing, but this will not affect the multicooker's safety or performance.

## Care, cleaning and storage

### **WARNING**

The multicooker base contains electrical components. To avoid fire, electric leakage and/or personal injury, make sure the multicooker base always stays dry.

- DO NOT immerse the multicooker base in water or other liquid or attempt to cycle it through the dishwasher.
- DO NOT rinse the heating element.
- DO NOT submerge or rinse the power cord or the plug.

# Care, cleaning and storage

## Removing and installing parts

### Silicone sealing ring

#### Remove the sealing ring

Grip the edge of the silicone and pull the sealing ring out from behind the circular stainless-steel sealing ring rack.

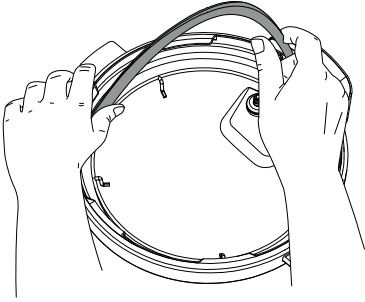

With the sealing ring removed, check the ring rack to make sure it is secured, centered, and an even height all the way around the lid. Do not attempt to repair a deformed ring rack.

 **Instant Tip:** The sealing ring is easiest to remove and install when it is wet and soapy.

#### Install the sealing ring

Place the sealing ring over the sealing ring rack and firmly press it into place. Make sure there's no puckering.

 It should be snug behind sealing ring rack. It can wiggle a bit but shouldn't fall out when you turn over the lid.

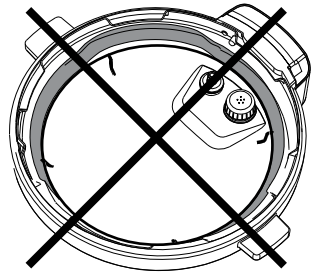
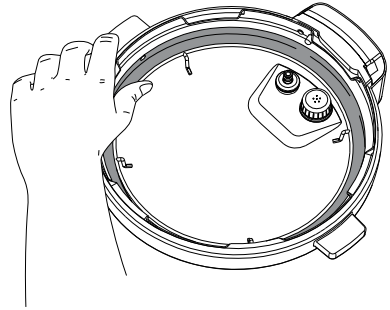

# Care, cleaning and storage

## Steam release assembly

### **Remove the steam release assembly**

Remove the steam release cover, then pull the steam release valve up and off the steam release pipe.

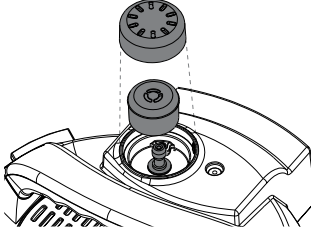

### **Install the steam release assembly**

Place the steam release valve on the steam release pipe and press down firmly.

 The steam release valve sits loosely on the steam release pipe but should remain in place when the lid is turned over.

Place the steam release cover over the steam release valve and press down. The cover is pressure-fit in place.

## Anti-block shield

### **Remove the anti-block shield**

Grip the lid like a steering wheel and use your thumbs to press firmly against the side of the anti-block shield (pressing towards the side of the lid and up) until it pops off the prongs underneath.

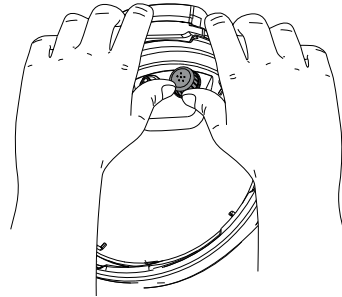

### **Install the anti-block shield**

Place anti-block shield over prongs and press down until it snaps into position.

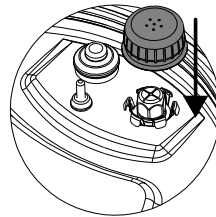

# Care, cleaning and storage

## Float valve and silicone cap

### **Remove the float valve from the lid**

Place one finger on the flat top of float valve, then turn the lid over. Detach the silicone cap from the bottom side of the float valve, and remove the float valve from the top of the lid.

 Do not discard the float valve or silicone cap.

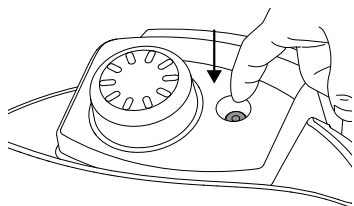

Top

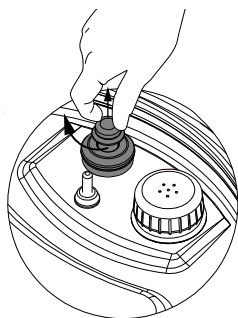

Bottom

### **Install the float valve**

Drop the narrow end of the float valve into the float valve hole on the top of the lid. Place one finger on the flat top of the float valve, then turn the lid over. Firmly attach the silicone cap to the bottom of the float valve.

## Condensation collector

The condensation collector sits at the back of the multicooker base and catches any overflow from the condensation rim.

### **Remove the condensation collector**

Pull the condensation collector away from the multicooker base; **do not pull down**.

 The tabs on the multicooker base and the grooves on the condensation collector.

### **Install the condensation collector**

Align the grooves on the condensation collector over the tabs on the back of the multicooker base and slide the condensation collector into place like closing a drawer.

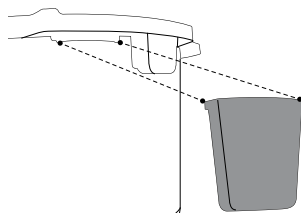

## QuickCool protective cover

### **Remove the protective cover**

Grip the tab and push it towards the lid handle, then pull it up, towards you, and off.

### **Install the protective cover**

Grip the tab and slide the cover towards the back of the metal portion of the lid, then press down until it clicks.

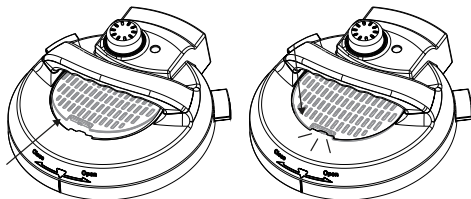



# Troubleshooting

**Register** your Instant Pot Pro Plus today!

If your issue persists or you have any additional questions, get in touch with a Customer Care Advisor through our chat widget at [instantpot.com/#chat](https://instantpot.com/#chat), by email at [support@instantpot.com](mailto:support@instantpot.com) or by phone at **1-800-828-7280**.

Problem	Possible reason	Try this
<b>Occasional clicking or light cracking sound.</b>	The sound of power switching, or the pressure board may be expanding due to changing temperatures.	This is normal; no action needed.
	Bottom of the inner pot is wet.	Wipe exterior surfaces of the inner pot. Make sure the heating element is dry before inserting the inner pot into the multicooker base.
<b>Difficulty closing the lid.</b>	Sealing ring is not properly installed.	Reposition the sealing ring. Make sure it is snug behind the sealing ring rack.
	Float valve is in the popped-up position.	Gently press the float valve downward with a long utensil.
	Contents in multicooker are still hot.	Lower the lid onto the multicooker base slowly, allowing heat to dissipate.
<b>Difficulty opening the lid.</b>	<b>⚠ DANGER</b> Contents may be under pressure. To avoid scalding injury, DO NOT attempt to force the lid open.	
	Pressure inside the multicooker.	Release pressure according to recipe. Only open the lid after the float valve has dropped down.
	Float valve stuck in the popped-up position due to food debris or residue.	Make sure steam is completely released by quick releasing pressure, then press the float valve gently with a long utensil. Open the lid cautiously, then thoroughly clean the float valve, surrounding area and lid before next use.
<b>The inner pot is stuck to the lid when the multicooker is opened.</b>	Cooling of the inner pot may create suction, causing the inner pot to adhere to the lid.	To release the vacuum, move the quick release switch into the <b>Vent</b> position.

# Troubleshooting

Problem	Possible reason	Try this
<b>Steam leaks from the side of the lid.</b>	No sealing ring in the lid.	Install a sealing ring.
	The sealing ring is damaged or not installed properly.	Replace the sealing ring.
	Food debris on to the sealing ring.	Remove the sealing ring and clean it thoroughly.
	The lid is not closed properly.	Open, then close the lid.
	The sealing ring rack is warped or off-center.	Remove the sealing ring from the lid, then check the sealing ring rack for bends or warps. Contact <b>Customer Care</b> .
	The inner pot rim may be misshapen.	Check for deformation and contact <b>Customer Care</b> .
<b>The float valve does not rise.</b>	Food debris on the float valve or float valve silicone cap.	Remove the float valve from the lid and clean it thoroughly. Perform the <b>Initial test run</b> to check for function and record your findings. Contact <b>Customer Care</b> .
	Too little liquid in the inner pot.	Check for scorching on the bottom of the inner pot. Add thin, water-based liquid to the inner pot according to its size. 8 Qt: 2 cups (500 mL / ~16 oz)
	Float valve silicone cap damaged or missing.	Install or replace the float valve and/or silicone cap.
	Float valve obstructed by lid-locking mechanism.	Tap the float valve with a long utensil. If the float valve does not drop, turn the multicooker off. Contact <b>Customer Care</b> .
	No heat in the inner pot.	Perform the <b>Initial test run</b> to check for function and record your findings. Contact <b>Customer Care</b> .
	Inner pot base may be damaged.	Perform the <b>Initial test run</b> to check for function and record your findings. Contact <b>Customer Care</b> .
	<b>Minor steam leaking or hissing from the steam release valve during Cooking.</b>	<b>Quick release switch is not in the Seal position.</b>
The multicooker is regulating excess pressure.		This is normal; no action required.
<b>Steam gushes from the steam release valve while the quick release switch is in the Seal position.</b>	Not enough liquid in the inner pot.	Add thin, water-based liquid to the inner pot according to its size. 8 Qt: 2 cups (500 mL / ~16 oz)
	Pressure sensor control failure.	Contact <b>Customer Care</b> .
	Steam release valve is not seated properly.	Release pressure, then make sure the steam release valve is installed properly. See <b>Care, cleaning and storage: Removing and installing parts</b> .

# Troubleshooting

Problem	Possible reason		Try this
The display remains blank after connecting the power cord.	Bad power connection or no power.		Check outlet to make sure it is powered. Inspect power cord for damage. If you notice damage, contact <b>Customer Care</b> .
	The multicooker's electrical fuse has blown.		Contact <b>Customer Care</b> .
Error code appears on the display and the multicooker beeps continuously.	C1 C3 C4 C6	Faulty sensor.	Contact <b>Customer Care</b> .
	C7	Heat element has failed.	Contact <b>Customer Care</b> .
		Not enough liquid.	Add thin, water-based liquid to the inner pot according to its size. 8 Qt: 2 cups (500 mL / (~16 oz))
	C8	Incorrect inner pot is used.	Only use a stainless-steel Pro Series inner pot with easy grip handles with the Pro Plus.
	E20	<b>Lid is missing.</b>	<b>SOMETHING</b>
	Lid	The lid is not in the correct position for the selected program.	Open and close the lid. Do not use a lid when using Sauté.
	Alt	The target temperature for safe canning was not reached.	Touch <b>Cancel</b> . Check that all seals are clean, positioned correctly, and undamaged. Make sure that you have at least 1 cup of water in the inner pot before restarting. Do not pressure can at altitudes above 2000 m (6600 ft). Refer to the <b>USDA's Complete Guide to Home Canning</b> for procedures and limitations.
	Food burn	The inner pot is not in the multicooker base.	Place the stainless-steel inner pot in the multicooker base.
	Food burn	High temperature was detected at the bottom of the inner pot; the multicooker automatically reduces the temperature to avoid overheating.	Starch deposits at the bottom of the inner pot may have blocked heat dissipation. Turn the multicooker off, release pressure and inspect the bottom of the inner pot.
PrSE	Pressure has accumulated during a non-pressure cooking Smart Program.	Touch <b>Cancel</b> and Quick Release pressure.	

Any other servicing must be performed by an authorized representative.

# Warranty

## Disclaimer of Implied Warranties

EXCEPT AS EXPRESSLY PROVIDED HEREIN AND TO THE EXTENT PERMITTED BY LAW, INSTANT BRANDS MAKES NO WARRANTIES, CONDITIONS OR REPRESENTATIONS, EXPRESS OR IMPLIED, BY STATUTE, USAGE, CUSTOM OF TRADE OR OTHERWISE WITH RESPECT TO THE APPLIANCES OR PARTS COVERED BY THIS WARRANTY, INCLUDING BUT NOT LIMITED TO, WARRANTIES, CONDITIONS, OR REPRESENTATIONS OF WORKMANSHIP, MERCHANTABILITY, MERCHANTABILITY, FITNESS FOR A PARTICULAR PURPOSE OR DURABILITY.

Some states or provinces do not allow for the exclusion of implied warranties of merchantability or fitness, so this limitation may not apply to you. In these states and provinces, you have only the implied warranties that are expressly required to be provided in accordance with applicable law.

## Limitation of Remedies; Exclusion of Incidental and Consequential Damage

YOUR SOLE AND EXCLUSIVE REMEDY UNDER THIS LIMITED WARRANTY SHALL BE APPLIANCE REPAIR OR REPLACEMENT AS PROVIDED HEREIN. INSTANT BRANDS SHALL NOT BE LIABLE FOR INDIRECT, INCIDENTAL OR CONSEQUENTIAL DAMAGES ARISING OUT OF OR IN CONNECTION WITH THE USE OR PERFORMANCE OF THE APPLIANCE OR DAMAGES WITH RESPECT TO ANY ECONOMIC LOSS, PERSONAL INJURY, LOSS OF PROPERTY, LOSS OF REVENUES OR PROFITS, LOSS OF ENJOYMENT OR USE, COSTS OF REMOVAL, INSTALLATION OR OTHER INDIRECT, INCIDENTAL OR CONSEQUENTIAL DAMAGES OF ANY NATURE OR KIND.

## Warranty Registration

Please visit [www.instantpot.com/support/register](http://www.instantpot.com/support/register) to register your new Instant Brands™ appliance and validate your warranty within thirty (30) days of purchase. You will be asked to provide the store name, date of purchase, model number (found on the back of your appliance) and serial number (found on the bottom of your appliance) along with your name and email address. The registration will enable us to keep you up to date with product developments, recipes and contact you in the unlikely event of a product safety notification. By registering, you acknowledge that you have read and understand the instructions for use, and warnings set forth in the accompanying instructions.

## Warranty Service

**To obtain service under this warranty, please contact our Customer Service Department by phone at 1-800-828-7280 or by email to [support@instantpot.com](mailto:support@instantpot.com). You can also create a support ticket online at [www.instantpot.com/support](http://www.instantpot.com/support). If we are unable to resolve the problem, you may be asked to send your appliance to the Service Department for quality inspection.** Instant Brands is not responsible for shipping costs related to warranty service, save and except for shipping costs associated with the return of your appliance from Canada or within the 48 contiguous states and the District of Columbia of the United States of America, as provided herein. When returning your appliance, please include your name, mailing address, email address, phone number, and proof of the original purchase date as well as a description of the problem you are encountering with the appliance.

# Warranty

## Limited Warranty

This Limited Warranty is effective for one year from the date of original consumer purchase. Proof of original purchase date and, if requested by an authorized representative of Instant Brands Inc. ("Instant Brands"), return of your appliance, is required to obtain service under this Limited Warranty. Provided that this appliance is operated and maintained in accordance with written instructions attached to or furnished with the appliance, Instant Brands will, in its sole and exclusive discretion, either: (i) repair defects in materials or workmanship; or (ii) replace the appliance. In the event that your appliance is replaced, the Limited Warranty on the replacement appliance will expire 12 months from the date of original consumer purchase.

**This Limited Warranty extends only to the original purchaser and use of the appliance in the United States of America and Canada. This warranty does not cover units that are used outside of the United States of America and Canada.**

Any modification or attempted modification to your appliance may interfere with the safe operation of the appliance and will void this Limited Warranty. This Limited Warranty does not apply in respect of any appliance or any part thereof that has been altered or modified unless such alterations or modifications were expressly authorized by an Instant Brands representative.

## Limitation and Exclusions

The liability of Instant Brands, if any, for any allegedly defective appliance or part shall in no circumstances exceed the purchase price of a comparable replacement appliance.

### **This Limited Warranty does not cover:**

1. Damage resulting from accident, alteration, misuse, abuse, neglect, unreasonable use, use contrary to the operating instructions, normal wear and tear, commercial use, improper assembly, disassembly, failure to provide reasonable and necessary maintenance, fire, flood, acts of God or repair by anyone unless directed by an Instant Brands Representative;
2. Repairs where your appliance is used for other than normal, personal use or when it is used in a manner that is contrary to published user or operator instructions; or
3. Use of unauthorized parts and accessories, or repairs to parts and systems resulting from unauthorized repairs or modifications made to this appliance.

The cost of repair or replacement under these excluded circumstances shall be paid by you.



**Instant Brands Inc.**

11–300 Earl Grey Dr., Suite 383  
Ottawa, Ontario  
K2T 1C1  
Canada

Register your product today  
**[instantpot.com/support/register](https://instantpot.com/support/register)**

**Contact us**

**1-800-828-7280**

[support@instantpot.com](mailto:support@instantpot.com)  
[instantpot.com/#chat](https://instantpot.com/#chat)

[instantpot.com](https://instantpot.com)  
[store.instantpot.com](https://store.instantpot.com)