

# levoit

---

USER MANUAL

## Ultrasonic Cool Mist Humidifier

**Model:** Classic 100

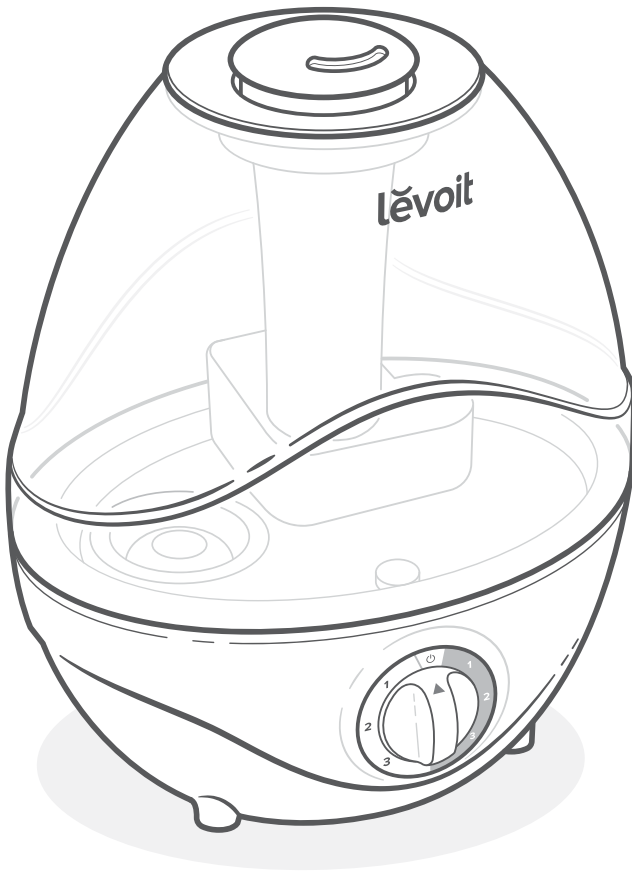

### Questions or Concerns?

Please contact us Mon–Fri, 9:00 am–5:00 pm PST/PDT at [support@levoit.com](mailto:support@levoit.com) or at **(888) 726-8520**.

Thank you for purchasing the  
**ULTRASONIC COOL MIST  
HUMIDIFIER BY LEVOIT.**

If you have any questions or concerns, please reach out to us at [support@levoit.com](mailto:support@levoit.com). We hope you enjoy your new humidifier!

**Find Us Online**

Search for [@LevoitLifestyle](#) • [#LevoitLove](#) • [#LevoitLifestyle](#) on social media for tips, special deals, giveaways, inspiration, and more.

## Table of Contents

Package Contents	3
Specifications	3
Safety Information	5
Getting to Know Your Humidifier	6
Getting Started	7
Using Your Humidifier	9
Important Tips	10
Care & Maintenance	10
Troubleshooting	14
Warranty Information	16
Customer Support	17

## Package Contents

- 1 x Ultrasonic Cool Mist Humidifier
- 1 x Power Adapter
- 1 x Cleaning Brush
- 1 x User Manual
- 1 x Quick Start Guide

## Specifications

<b>Rated Power</b>	DC 24V, 24W
<b>Water Tank Capacity</b>	0.63 gal / 2.4 L
<b>Max Run Time</b>	Up to 24 hours on low mist setting <b>Note:</b> <i>The humidifier may run for a longer or shorter time depending on environmental temperature and humidity.</i>
<b>Noise Level</b>	≤ 30dB
<b>Effective Range</b>	107–290 ft <sup>2</sup> / 10–27 m <sup>2</sup>
<b>Dimensions</b>	8.5 x 6.7 x 10.2 in / 21.7 x 17 x 26 cm
<b>Weight</b>	2.5 lb / 1.1 kg
<b>Adapter Rated Power</b>	<b>Input:</b> AC 100–240V, 50/60Hz <b>Output:</b> DC 24V, 1A

# SAFETY INFORMATION

To reduce the risk of fire, electric shock, or other injury, follow all instructions and safety guidelines.

## General Safety

- **Only** use the humidifier as described in this manual.
- Place the humidifier and power adapter cord so that it will not be knocked over. **Do not** place near large pieces of furniture or in areas with high foot traffic.
- When not in use, turn the humidifier off and disconnect from power by removing the power adapter from the outlet.
- **Do not** use the humidifier in wet environments.
- Keep the humidifier out of reach from children.
- To avoid risk of electric shock, **always** unplug the humidifier from the power outlet before cleaning it or detaching the water tank from the base.
- **Always** make sure the humidifier is placed on a hard, flat, level surface before operation.
- **Do not** place the humidifier near sources of heat, such as stovetops, ovens, or radiators.
- **Do not** place the humidifier directly on floors, carpets, or rugs. **Only** place on water-resistant surfaces.
- **Do not** place foreign objects into the humidifier base or water tank.
- **Do not** use power adapters that are not recommended by Levoit for the humidifier.
- **Do not** cover the nozzle while the humidifier is on. Doing so may damage the humidifier.
- **Do not** allow water or other liquids into the air outlet.
- Remove the water tank from the base before moving the humidifier.
- **Do not** immerse the humidifier base or power adapter in water.
- **Always** allow the humidifier to completely cool before cleaning.
- **Do not** use detergents to clean the humidifier. **Only** use distilled white vinegar.
- If the humidifier is damaged or is not functioning properly, stop using it and contact **Customer Support** immediately (see page 17).
- Not for commercial use. Household use **only**.

## Power Adapter

- **Do not** handle the power adapter with wet hands. Keep the power adapter away from liquids.

### Caution: Risk of Leaks and Electric Shock

**Do not** add essential oils, water treatment liquids, or third-party water filters into the humidifier (including the water tank or base chamber). This will damage the humidifier and cause leaks.

# READ AND SAVE THESE INSTRUCTIONS

# CONSIGNES DE SÉCURITÉ

Pour réduire les risques d'incendie et d'électrocution ou éviter d'autres blessures, suivez toutes les instructions et consignes de sécurité.

## Consignes générales de sécurité

- Utilisez **uniquement** le déshumidificateur comme décrit dans ce manuel.
- Disposez le déshumidificateur et son cordon adaptateur de façon à ce que l'appareil ne se renverse pas. **Ne pas** installer l'appareil près de meubles imposants ou dans des zones très fréquentées.
- Lorsqu'il n'est pas utilisé, éteignez le déshumidificateur et débranchez-le de l'alimentation en retirant l'adaptateur de la prise murale.
- **Ne pas** utiliser l'humidificateur dans des environnements humides.
- Maintenez l'humidificateur hors de portée des enfants.
- Pour éviter les risques de chocs électriques, débranchez **toujours** le déshumidificateur de la prise murale avant de le nettoyer ou de retirer le réservoir d'eau de la base.
- Assurez-vous **toujours** que le déshumidificateur est placé sur une surface rigide, plane et à niveau avant toute utilisation.
- **Ne pas** placer le déshumidificateur près de sources de chaleur, comme les dessus de poêle, les fours ou les radiateurs.
- **Ne pas** placer le déshumidificateur directement sur les planchers, les tapis ou les moquettes. Placez-le **seulement** sur des surfaces résistantes à l'eau.
- **Ne pas** placer d'objets étrangers dans la base de l'humidificateur ou le réservoir d'eau.
- **Ne pas** utiliser d'adaptateurs non recommandés par Levoit pour cet humidificateur.
- **Ne pas** recouvrir la base lorsque l'humidificateur est en marche. Ceci pourrait endommager l'appareil.
- **Ne pas** permettre l'entrée d'eau ou de tout autre liquide dans la prise d'air.
- Enlevez le réservoir d'eau de la base avant de déplacer le déshumidificateur.
- **Ne pas** plonger la base de l'humidificateur ou l'adaptateur dans l'eau.
- **Toujours** laisser l'humidificateur se refroidir complètement avant de le nettoyer.
- **Ne pas** utiliser de détergents pour nettoyer le déshumidificateur. Utilisez **seulement** du vinaigre blanc distillé.
- Si l'humidificateur est endommagé ou ne fonctionne pas correctement, arrêtez de l'utiliser et contactez immédiatement le **Service client** (voir la page 17).
- Non adapté à un usage commercial. Pour un usage domestique **seulement**.

## Adaptateur d'alimentation

- **Ne pas** manipuler l'adaptateur avec les mains mouillées. Tenez l'adaptateur éloigné des liquides.

### Mise en garde : Risque de fuites et de chocs électriques

**Ne pas** ajouter d'huiles essentielles, de liquides de traitement de l'eau ou de filtres à eau tiers dans le déshumidificateur (y compris le réservoir d'eau ou le compartiment de la base). Ceci endommagera le déshumidificateur et provoquera des fuites.

# INSTRUCTIONS À LIRE ET À CONSERVER

# GETTING TO KNOW YOUR HUMIDIFIER

- |                 |                    |                   |                   |
|-----------------|--------------------|-------------------|-------------------|
| A. Nozzle       | F. Air Outlet      | K. Transducer     | P. Power Socket   |
| B. Nozzle Cap   | G. Base            | L. Water Tank Cap | Q. Air Inlet      |
| C. Mist Tube    | H. Night Light     | M. Float Housing  | R. Power Adapter  |
| D. Water Tank   | I. Mist Level Dial | N. Float          | S. Cleaning Brush |
| E. Base Chamber | J. Insulation Ring | O. Noise Silencer |                   |

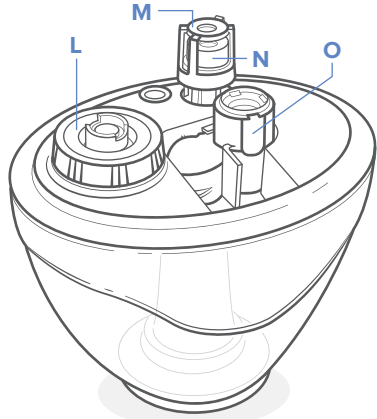
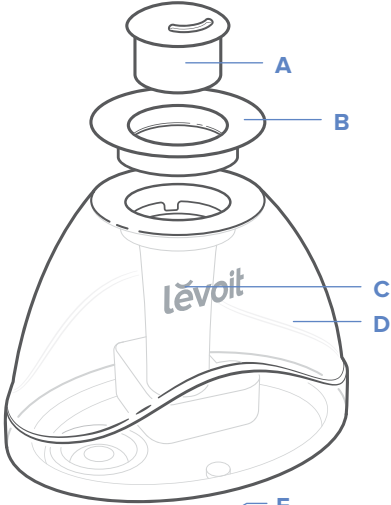

*Underside of Water Tank*

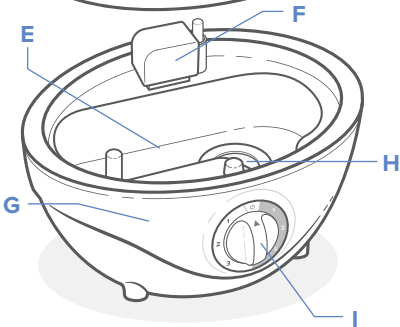

*Front*

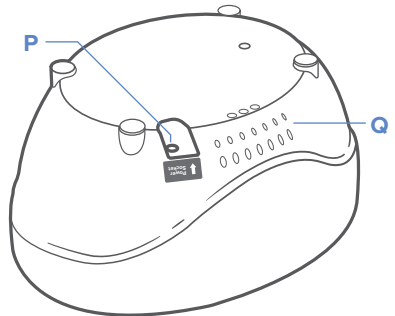

*Underside of Base*

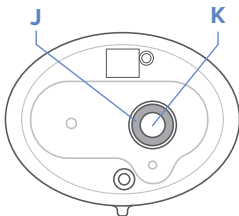

*Top view of Inner Chamber*

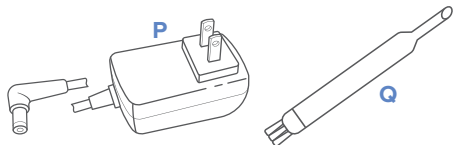

# GETTING STARTED

1. Remove all packaging. Choose a hard, flat location for the humidifier at least 6 in / 15 cm away from any walls. The surface must be water-resistant.
2. Make sure the mist nozzle is directed away from walls, furniture, bedding, and appliances.
3. Connect the power adapter to the base.

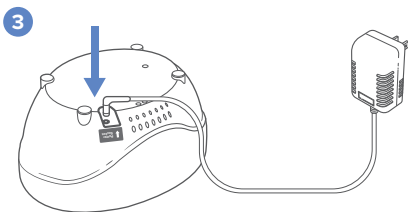
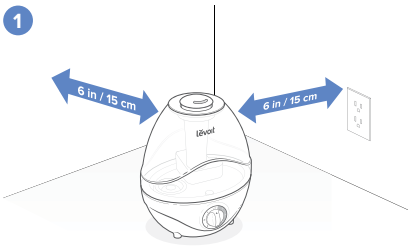

# Filling & Refilling

1. Remove the nozzle and nozzle cap from the water tank.
2. Flip over the water tank and remove the water tank cap by twisting it counterclockwise.
3. Fill the tank with cool water. **Do not** fill with warm or hot water.

**Note:** We recommend using purified or distilled water in the humidifier.

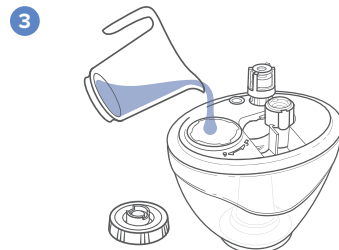
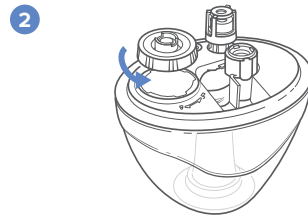

## Filling & Refilling (Cont.)

### CAUTION

- **Do not** add water directly into the base chamber.
- **Do not** add water through the mist tube.
- **Do not** add essential oils into the humidifier.

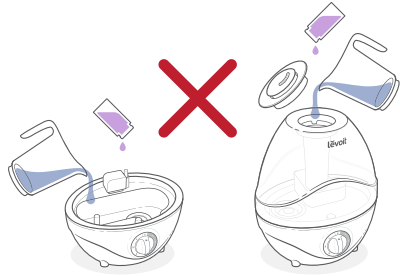

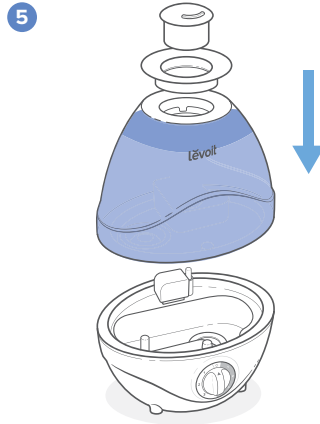
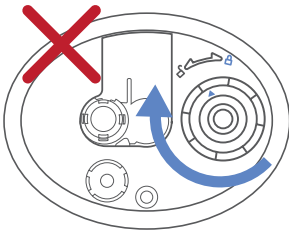
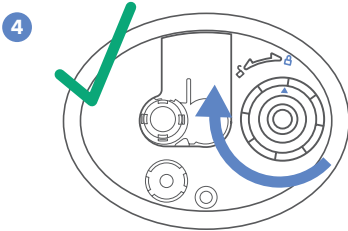

4. Replace the water tank cap by firmly twisting it back in place, aligning the arrow with the lock.
5. Place the tank properly on the base. Replace the nozzle and nozzle cap onto the water tank.





# USING YOUR HUMIDIFIER

**Note:** If there is no water in the tank, the humidifier will not turn on and  will light up red. Fill the water tank (see **Filling & Refilling**, page 7).

1. Plug in the adapter.
2. Turn the dial to the desired setting. *[Figure 1.1]*
3. Rotate the nozzle to adjust the direction of the mist.
4. When your room has reached a comfortable humidity level, turn your humidifier to a lower setting or turn it off. A comfortable humidity level is above 40% and below 60%.
5. Turn the dial to  to turn the humidifier off.

3



4

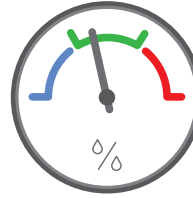

5

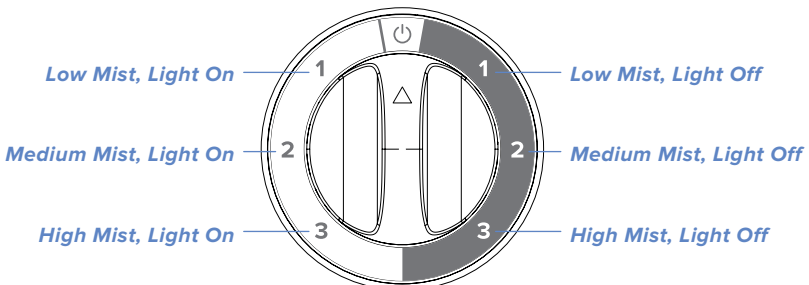
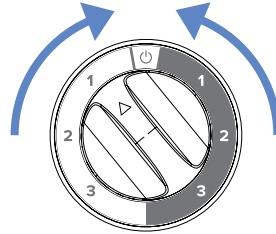

Figure 1.1

## IMPORTANT TIPS

- **Never** pour water directly into the base chamber. [Figure 2.1] **Only** add water to the water tank. The humidifier will automatically release the correct amount of water into the base chamber.
- Avoid moving or shaking the humidifier. [Figure 2.2] This may cause the water tank to release too much water into the base chamber.
- Before moving the humidifier, turn it off, unplug it, and remove the water tank.
- If your humidifier doesn't produce mist correctly, check the max water line [Figure 2.3] to see if there is too much water in the base chamber. Pour out any extra water if water is over the max line.

**Note:** The max water line is **only** for this purpose. **Do not pour water into the base.**



Figure 2.1



Figure 2.2

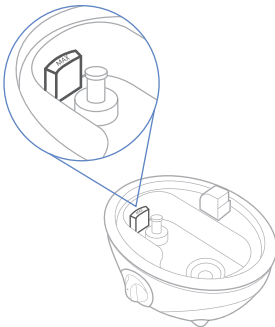

Figure 2.3

## CARE & MAINTENANCE

### Note:

- All maintenance should be done on a water-resistant surface, such as a kitchen counter.
- Change the water daily to avoid bacteria growth.
- Use a tissue or cloth to clean the nozzle regularly.
- If not using the humidifier for 1 week or longer, **do not** leave water inside. Clean and dry the humidifier instead.

### Cleaning

You should clean your humidifier every week, and when you're ready to store it.

### Note:

- **Never** immerse the base in water or liquid. **Do not** place any part of the humidifier in a dishwasher.
  - **Do not** use detergents to clean the humidifier.
1. Unplug the humidifier and remove the power adapter from the base.

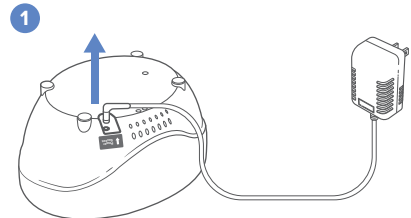

## Cleaning (Cont.)

2. Remove and rinse the nozzle and nozzle cap.
3. Remove the water tank from the base. Pour out all water from the tank and base.
4. Rinse the tank and the base chamber with room temperature water.

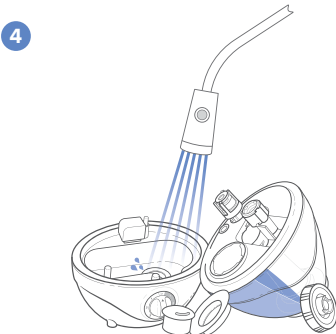
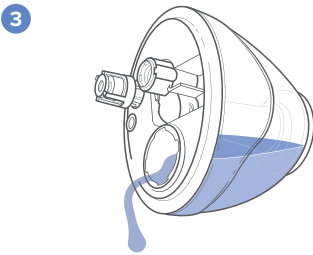
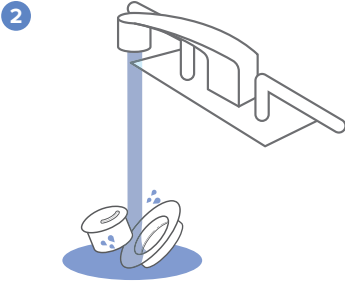

5. To descale the humidifier:
  01. Fill the water tank with 2 US cups / 237 mL of distilled white vinegar.
  02. Replace the tank cap and swish the vinegar around in the tank.
  03. Place the tank properly on the base. Vinegar will drain into the base chamber and loosen scale (mineral buildup) in the tank and in the base (including the transducer and float).

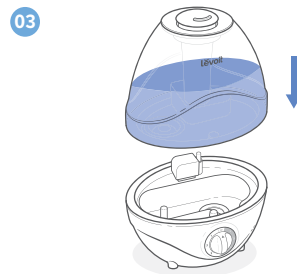
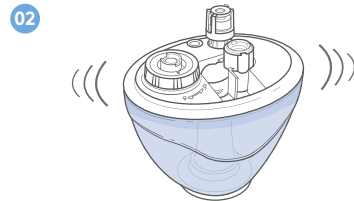
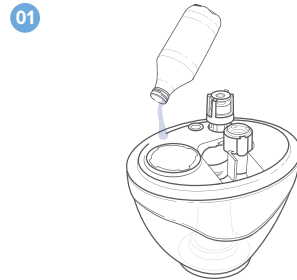

## Cleaning (Cont.)

04. Soak for 15–20 minutes.
05. Remove the tank and pour out any vinegar.
06. Flip the tank over and remove the tank cap and noise silencer.
07. Place the tank cap and noise silencer in a small container (or the base chamber). Fill with enough vinegar to cover them. Soak for 15–20 minutes.

04



05

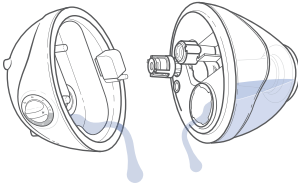

06

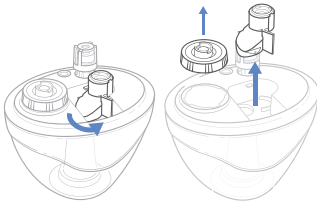

07

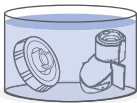

08. Use a soft cloth and the included cleaning brush to remove scale.

09. Rinse all parts until any vinegar smell is completely gone.

6. Dry all parts with a cloth. Make sure all parts are completely dry.

08

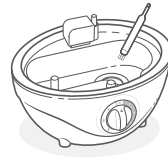

09

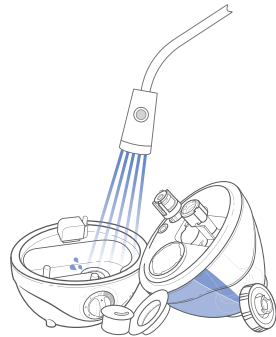

## Reassembling

1. Flip the water tank over and replace the noise silencer on the tank.
2. Refill the tank, if necessary. Replace the water tank cap by firmly twisting it back in place, aligning the arrow with the lock.
3. Place the tank properly on the base. Replace the nozzle and nozzle cap onto the water tank.

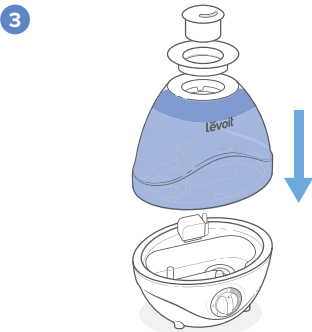
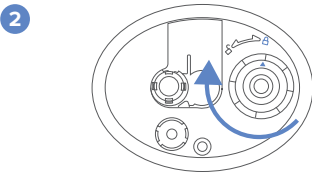
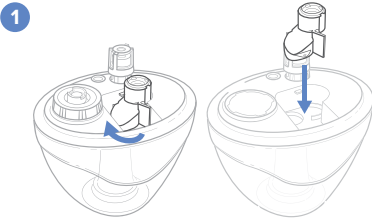

## Storing

Follow the cleaning instructions and allow all parts to dry completely before storing. Store in a cool, dry location.

# TROUBLESHOOTING

Problem	Possible Solution
Humidifier doesn't turn on.	Make sure the power adapter is correctly plugged into a working outlet.
	Make sure the power adapter is correctly plugged into the humidifier base.
Little or no mist comes out.	Turn the mist level dial to a higher setting.
	Fill the water tank.
	There may be too much water in the base chamber. Empty the base chamber. Refill the water tank (not the base chamber) and place the water tank properly onto the base.
	Make sure the air inlet on the bottom of the base is not blocked. The humidifier should not be set on carpet or other surfaces that may block the air inlet.
	Make sure the nozzle is not blocked or clogged.
	Make sure the humidifier is on a level surface.
	The water temperature may be too low. Turn the mist level dial to the highest setting and let the humidifier run for a while, then adjust to the desired setting.
	If the water tank or base was washed with detergent, rinse thoroughly with clean water to remove any detergent.
Humidifier uses water too quickly.	The humidifier uses up water based on the environmental temperature and humidity. If your environment is cold and/or dry, the humidifier will run out of water faster.
Humidifier produces an unusual smell.	Clean the water tank and base chamber (see <b>Care &amp; Maintenance</b> , page 10).
Water leaks from the humidifier.	Tighten the water tank cap.
	Check the water tank for leaks. If there are leaks, contact <b>Customer Support</b> (see page 17).
Condensation forms around humidifier or windows.	Humidity may be too high. Turn down the mist level, turn off the humidifier, or open the door to the room.

## TROUBLESHOOTING (CONT.)

Problem	Possible Solution
Mist is leaking from the base.	Empty the base chamber. Refill the water tank (not the base chamber) and place the water tank properly onto the base.
White dust appears around the humidifier.	Use purified or distilled water to fill the humidifier. Avoid using water with high mineral content.
	Clean the humidifier (see <a href="#">Care &amp; Maintenance</a> , page 10).
 is red.	Fill the water tank.
	Place the water tank properly on the base.

If your problem is not listed, please contact [Customer Support](#) (see page 17).

# WARRANTY INFORMATION

Product	Ultrasonic Cool Mist Humidifier
Model	Classic 100
Default Warranty Period	1 year
<i>For your own reference, we strongly recommend that you record your order ID and date of purchase.</i>	
Date of Purchase	
Order ID	

## Terms & Policy

Arovast Corporation warrants all products to be of the highest quality in material, craftsmanship, and service, effective from the date of purchase to the end of the warranty period.

Arovast Corporation will replace any product found to be defective due to manufacturer flaws based on eligibility. Refunds are available within the first 30 days of purchase. Refunds are only available to the original purchaser of the product. This warranty extends only to personal use and does not extend to any product that has been used for commercial, rental, or any other use for which the product is not intended. There are no warranties other than the warranties expressly set forth with each product.

This warranty is non-transferrable. Arovast Corporation is not responsible in any way for any damages, losses, or inconveniences caused by equipment failure by user negligence, abuse, or use noncompliant with the user manual or any additional safety, use, or warnings included in the product packaging and manual.

### **This warranty does not apply to the following:**

- Damage due to abuse, accident, alteration, misuse, tampering, or vandalism.
- Improper or inadequate maintenance.
- Damage in return transit.
- Unsupervised use by children under 18 years of age.

Arovast Corporation and its subsidiaries assume no liability for damage caused by the use of the product other than for its intended use or as instructed in the user manual. Some states **do not** allow this exclusion or limitation of incidental or consequential losses so the foregoing disclaimer may not apply to you. This warranty gives you specific legal rights and you may also have other rights which may vary from state to state.

**ALL EXPRESSED AND IMPLIED WARRANTIES, INCLUDING THE WARRANTY OF MERCHANTABILITY, ARE LIMITED TO THE PERIOD OF THE LIMITED WARRANTY.**

## Extend Your Warranty by 1 Year

Register your product at [www.levoit.com/warranty](http://www.levoit.com/warranty) to extend your 1-year warranty by an additional year.

Please fill out all required fields and include your order ID, place of purchase, and purchase date, if applicable.

## Defective Products & Returns

If you discover your product is defective within the specified warranty period, please contact Customer Support via [support@levoit.com](mailto:support@levoit.com) with a copy of your invoice and order ID. **DO NOT** dispose of your product before contacting us. Once our Customer Support Team has approved your request, please return the product with a copy of the invoice and order ID.



# CUSTOMER SUPPORT

If you encounter any issues or have any questions regarding your new product, feel free to contact our helpful Customer Support Team.

**Arovast Corporation**

1202 N. Miller St., Suite A  
Anaheim, CA 92806

**Email:** [support@levoit.com](mailto:support@levoit.com)

**Toll-Free:** (888) 726-8520

## Support Hours

Mon–Fri, 9:00 am–5:00 pm PST/PDT

\*Please have your order invoice and order ID ready before contacting Customer Support.



Connect with us @LevoitLifestyle



**lěvoit**

[levoit.com](http://levoit.com)