

USER MANUAL

# VeSync Classic 300S Ultrasonic Smart Humidifier

**Product Series:** Classic 300S

**Models:** Classic 300S, LUH-A601S-WUSB

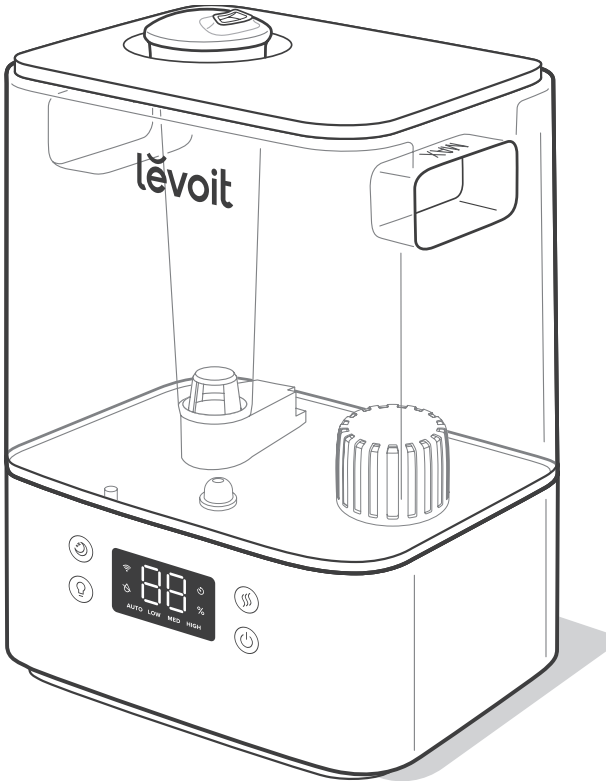

## Questions or Concerns?

Please contact us Mon–Fri, 9:00 am–5:00 pm PST/PDT  
at [support@levoit.com](mailto:support@levoit.com) or at **(888) 726-8520**.

## Table of Contents

Package Contents	2
Specifications	2
Safety Information	3
Getting to Know Your Smart Humidifier	5
Controls	7
Getting Started	8
VeSync App Setup	11
Using Your Smart Humidifier	12
Care & Maintenance	16
Troubleshooting	22
VeSync App Troubleshooting	24
Warranty Information	26
Customer Support	27

## Package Contents

1 × Smart Ultrasonic Humidifier
3 × Aroma Pads (1 Pre-Installed)
1 × Cleaning Brush
1 × User Manual
1 × Quick Start Guide

## Specifications

<b>Power Supply</b>	AC 120V, 60Hz
<b>Rated Power</b>	26W
<b>Water Tank Capacity</b>	1.58 gal / 6 L
<b>Max Run Time</b>	Up to 60 hours on low mist setting <b>Note:</b> <i>The humidifier may run for a longer or shorter time depending on the environmental temperature and humidity.</i>
<b>Noise Level</b>	≤ 30dB
<b>Effective Range</b>	215–505 ft <sup>2</sup> / 20–47 m <sup>2</sup>
<b>Dimensions</b>	9.6 x 7.5 x 13.4 in / 24.5 x 19.2 x 34 cm
<b>Weight</b>	4.3 lb / 2 kg

**Note:** To access additional smart humidifier functions, download the free VeSync app (see page 11).

# READ AND SAVE THESE INSTRUCTIONS

## SAFETY INFORMATION

To reduce the risk of fire, electric shock, or other injury, follow all instructions and safety guidelines.

### General Safety

- **Only** use the humidifier as described in this manual.
- Place the humidifier and cord so that it will not be knocked over. **Do not** place near large pieces of furniture or in high-traffic areas.
- When not in use, turn the humidifier off and disconnect from power by removing the plug from the outlet.
- **Do not** use the humidifier in wet environments.
- Keep the humidifier out of reach from children.
- **Do not** open the base or remove the water level sensor for self-servicing.
- **Always** unplug your humidifier from the power outlet before cleaning your humidifier or detaching the water tank from the humidifier base.
- **Always** make sure to place the humidifier on a flat, level surface before operation.
- **Only** fill the water tank with clean water. **Never** fill the water tank with any other liquids.
- **Do not** place the humidifier near sources of heat, such as stovetops, ovens, or radiators.
- **Do not** place the humidifier directly on floors, carpets, or rugs.
- **Do not** use other items as replacement parts for this product.
- **Do not** cover the nozzle while the humidifier is on. Doing so may damage the humidifier.
- Remove the water tank from the base before moving the humidifier.
- **Do not** immerse the humidifier base, power cord, or plug in water.
- If the humidifier is damaged or is not functioning properly, stop using it and contact **Customer Support** immediately (see page 27).
- Not for commercial use. Household use **only**.

### Caution: Risk of Leaks and Electric Shock

**Do not** add essential oils, supplemental water treatment liquids, or water filters into the water tank or base chamber. This will damage the humidifier and cause leaks. **Only** add essential oils to the aroma pad.

## SAFETY INFORMATION (CONT.)

### Power & Cord

- Ensure that the plug fits properly into a polarized socket.
- **Do not** handle the power cord or plug with wet hands. Keep the plug and power cord away from liquids.
- Your humidifier has a polarized plug (one prong is wider than the other), which fits into a polarized outlet only one way. This is a safety feature to reduce the risk of electric shock. If the plug does not fit, reverse the plug. If it still does not fit, **do not** use the plug in that outlet. **Do not** bypass this safety feature.

# GETTING TO KNOW YOUR SMART HUMIDIFIER

- |                                 |                                 |                                       |
|---------------------------------|---------------------------------|---------------------------------------|
| <b>A.</b> Nozzle                | <b>K.</b> Water Tank Handles    | <b>U.</b> Air Outlet                  |
| <b>B.</b> Water Tank Cover      | <b>L.</b> Water Filter          | <b>V.</b> Air Inlet                   |
| <b>C.</b> Dust Cover            | <b>M.</b> Power Cord            | <b>W.</b> Humidity Sensor             |
| <b>D.</b> Mist Tube             | <b>N.</b> Float                 | <b>X.</b> Feet                        |
| <b>E.</b> Water Tank            | <b>O.</b> Float Brackets        | <b>Y.</b> Water Outlet Valve Assembly |
| <b>F.</b> Night Light           | <b>P.</b> Aroma Box             | <b>Z.</b> Water Outlet Valve          |
| <b>G.</b> Base                  | <b>Q.</b> Aroma Pad             | <b>AA.</b> Night Light Cover          |
| <b>H.</b> Display               | <b>R.</b> Max Water Line (Base) | <b>AB.</b> Noise Silencer             |
| <b>I.</b> Cleaning Brush        | <b>S.</b> Secondary Float       | <b>AC.</b> Tank Placement Sensor      |
| <b>J.</b> Max Water Line (Tank) | <b>T.</b> Transducer            |                                       |

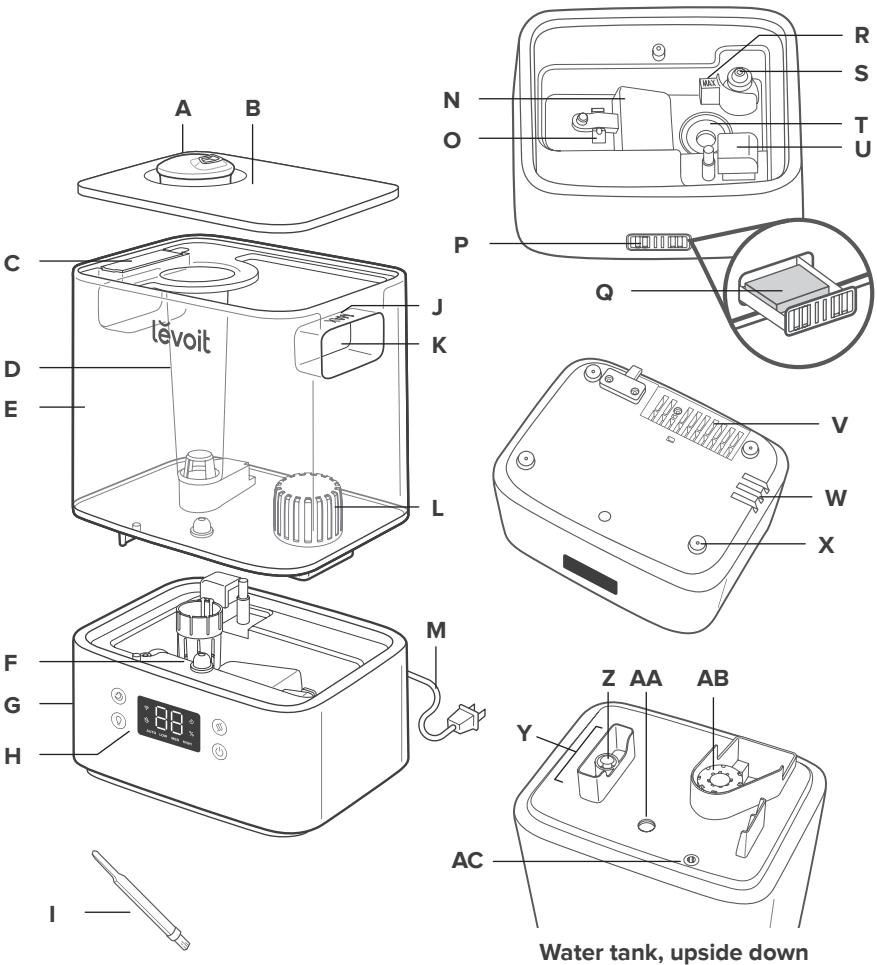

**Water tank, upside down**

## Getting To Know Your Smart Humidifier (cont.)

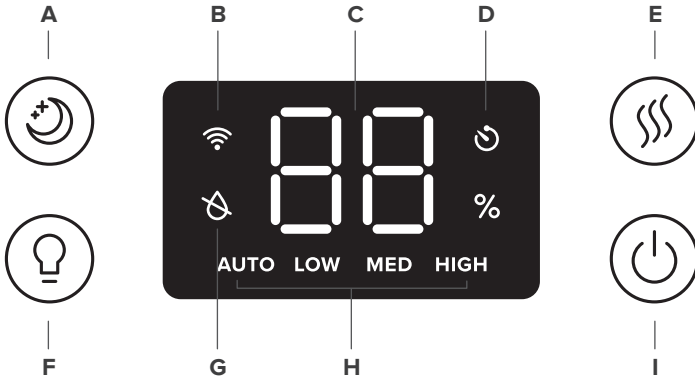

- A.** Sleep Mode Button
- B.** Wi-Fi® Indicator
- C.** Humidity Level
- D.** Timer Indicator
- E.** Mist Level Button
- F.** Night Light Button
- G.** No Water Indicator
- H.** Mist Level Indicator
- I.** Power Button

**Note:** The timer must be set in the VeSync app.

# CONTROLS

**Note:** You can also control these functions using the VeSync app, as well as additional functions (see page 13).



## Power Button

- Press to turn the humidifier on/off.
- Press and hold for 5 seconds to pair with the VeSync app. See the VeSync in-app instructions for more information.
- Press and hold for 15 seconds to reset the humidifier. This will restore the humidifier's default settings and disconnect it from Wi-Fi® and the VeSync app (see page 11).



## Mist Level Button

- Press repeatedly (or press and hold) to cycle through mist level settings: Auto Mode, Low, Medium, and High. (For more details on Auto Mode, see page 13.)
- Press during Sleep Mode to turn Sleep Mode off. The humidifier will keep misting on Auto Mode.



## Sleep Mode Button

- Press to turn Sleep Mode on/off (see page 13).



## Night Light Button

- Press repeatedly to cycle through night light settings: 50%, 100%, and Off.
- Press and hold for 3 seconds to turn the display and the night light off.
- Press and hold for 3 seconds during Sleep Mode to turn Sleep Mode off.

# GETTING STARTED

1. Remove all packaging.
2. Take the water tank off of the base and **remove all tape**, including any tape on the float. [Figure 1.1]

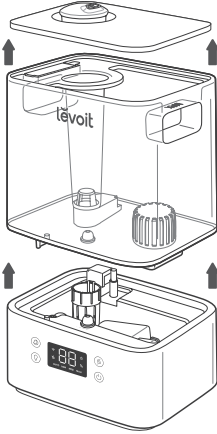

Figure 1.1

3. Clean the water tank and water tank cover before first use.

**Note:** Check to make sure that the water filter is correctly in place. If not, then rotate the filter clockwise to secure it in place. [Figure 1.2]

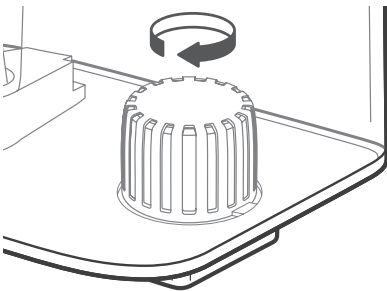

Figure 1.2

4. Choose a hard, flat location for the humidifier at least 12 inches / 30 cm away from any walls. The surface must be water-resistant. [Figure 1.3]

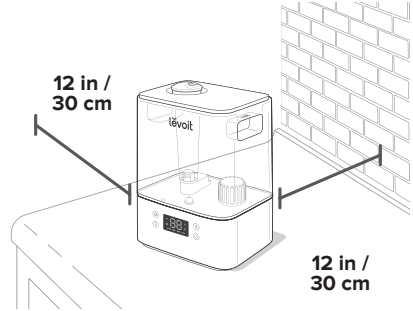

Figure 1.3

5. Mist should be directed away from walls, furniture, bedding, and appliances. [Figure 1.4]

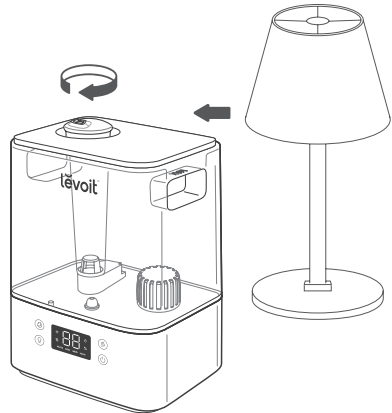

Figure 1.4



## Filling & Refilling

**Note:** Make sure the water tank is clean before filling.

1. Remove the water tank cover by holding the nozzle and pulling upward.  
[Figure 1.5]

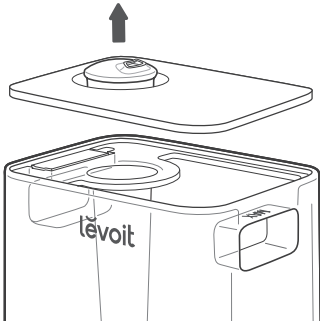

Figure 1.5

2. Use the handles to remove the tank from the base. Fill the tank with room-temperature water. [Figure 1.6]  
**Do not** fill with hot water.

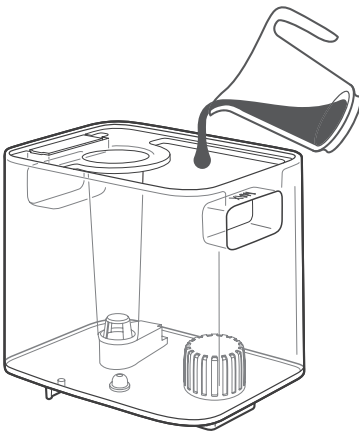

Figure 1.6

**Note:**

- We recommend using purified or distilled water to fill the tank.
- **Do not** fill past the tank's max water line.

### CAUTION

- **Do not** add water directly into the base chamber. [Figure 1.7]

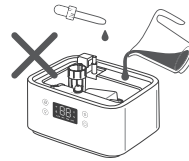

Figure 1.7

- **Do not** add water through the mist tube.
- **Do not** add essential oils into the humidifier. [Figure 1.8] **Only** add essential oils to the aroma pad. [Figure 1.9]

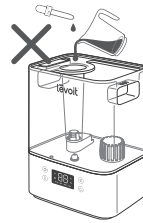

Figure 1.8

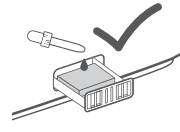

Figure 1.9

- **Do not** use water treatment liquids or third-party water filters in this humidifier.

## Filling & Refilling (cont.)

3. Replace the water tank cover and place the tank back on the base. [Figure 1.10]

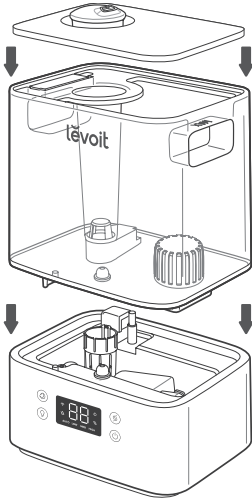

Figure 1.10

**Note:** Make sure the nozzle on the water tank cover is placed over the mist tube, or the humidifier may not work correctly. [Figure 1.11]

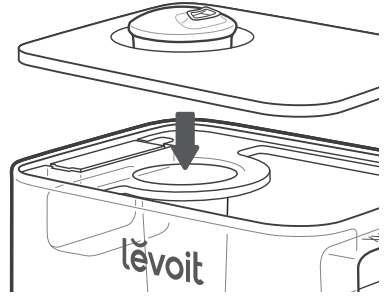

Figure 1.11

# VESYNC APP SETUP

**Note:** Due to ongoing updates and improvements, the VeSync app may be slightly different than shown in the manual. In case of any differences, follow the in-app instructions.

1. To download the VeSync app, scan the QR code or search “VeSync” in the Apple App Store® or Google Play Store. [Figure 2.1]

**Note:** For Android™ users, choose “Allow” to use VeSync.

2. Open the VeSync app. If you already have an account, tap **Log In**. To create a new account, tap **Sign Up**.

**Note:** You must create your own VeSync account to use third-party services and products. These will not work with a guest account. With a VeSync account, you can also allow your family and friends to control your smart humidifier.

3. Follow the in-app instructions to set up your smart humidifier.

**Note:** You can use the VeSync app to connect your smart humidifier to Amazon Alexa or Google Assistant™. Follow the in-app instructions to connect VeSync to your voice assistant.

## Wi-Fi Connection:



- To disconnect Wi-Fi, press and hold  for 15 seconds until the Wi-Fi indicator turns off. This will restore the smart humidifier's default settings and disconnect it from the VeSync app.
- To reconnect, please follow the instructions in the VeSync app for adding a device.





Figure 2.1

# USING YOUR SMART HUMIDIFIER

**Note:** Using the VeSync app allows you to control your smart humidifier remotely and access additional functions and features (see page 13).

1. Plug in the humidifier. Press  to turn your humidifier on.

**Note:** If there is no water in the tank,  will flash 10 times, and the humidifier will turn off. Fill the water tank (see **Getting Started**, page 8).

2. Tap  repeatedly to cycle through mist settings: Auto Mode, Low, Medium, and High. [Figure 3.1]

**Note:**

- The humidifier will not mist in Auto Mode if the humidity level is above 50%. If you want the humidifier to keep misting, change the mist setting, or change the Auto Mode settings in the VeSync app.
  - For more information about Auto Mode, see page 13.
3. Rotate the nozzle to adjust the direction of the mist. [Figure 3.2]
  4. Optionally, use the controls to activate Sleep Mode, turn the night light on/off, and more (see **Controls**, page 7).
  5. When your room has reached your preferred humidity level, turn the humidifier to a lower setting, or turn it off. A healthy humidity level is between 40% and 50%. [Figure 3.3]

**Note:** You can also use Auto Mode to keep the humidity level between 40% and 50%.

6. Press  to turn your humidifier off.

**Note:** If there is no water in the tank or the tank is removed, the humidifier will stop misting,  will flash 10 times, and the humidifier will turn off. Refill the tank and properly place it on the base to use your humidifier.

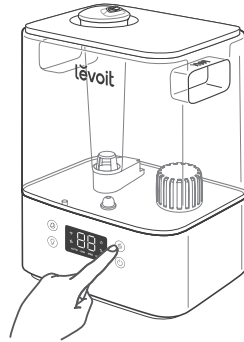

Figure 3.1

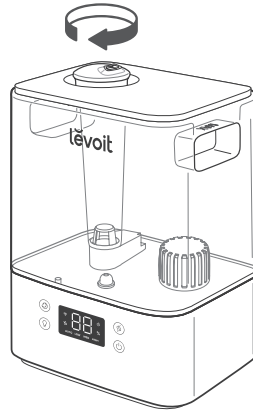



Figure 3.2



Figure 3.3

## Sleep Mode

Sleep Mode changes the humidifier's mist setting to Auto Mode, turns off the display lights, and turns off the night light.

- When Sleep Mode is on, you can press  to turn the night light on/off. The humidifier will stay in Sleep Mode.

## Auto Mode

Auto Mode uses the humidifier's sensor to automatically adjust the mist level (or turn it off) to maintain a comfortable and healthy level of humidity.

- Auto Mode automatically adjusts the mist level to maintain 40–50% relative humidity. You can change the target humidity level in the VeSync app.
- By default, Auto Mode uses Automatic Stop. The humidifier will stop misting when the highest target humidity level is reached. If the humidity drops below the target humidity level, the humidifier will begin misting again.
  - If Auto Mode is selected when the humidity is higher than the target humidity range, the humidifier will not start misting until the humidity lowers.
- In the VeSync app, you can turn Automatic Stop on/off. If Automatic Stop is off, the humidifier will keep running on Low mist level when the highest target humidity level is reached.

## VeSync App Functions

The VeSync app allows you to access additional smart functions, including those listed below.

### Remote Control

- Turn the humidifier on/off from your phone.
- Cycle through mist levels and turn on/off Auto Mode and Sleep Mode from your phone.
- Turn the display lights and night light on/off from your phone.
- Customize Auto Mode settings like target humidity and auto-off.

### Monitor Humidity Levels

- Check current humidity levels in the humidifier's environment.

### Set Timers & Schedules

- Program individual timers or create a schedule for your smart humidifier.

### Third-Party Voice Control

- Compatible with Amazon Alexa and Google Assistant™ for voice commands.

**Note:** *The VeSync app is continually updated and app features will expand.*

## Important Tips

Your humidifier must have the correct level of water in the base chamber to work properly. If there is too much water in the base chamber, the humidifier cannot create mist.

- **Never** pour water directly into the base chamber. [Figure 3.4] **Only** add water to the water tank. The humidifier will automatically release the correct amount of water into the base chamber.
- Avoid moving or shaking the humidifier. [Figure 3.5] This may cause the water tank to release too much water into the base chamber.
- Before moving the humidifier, turn it off, unplug it, and remove the water tank.
- If your humidifier doesn't produce mist correctly, check the max water line to see if there is too much water in the base chamber. Pour out extra water if water is over the max line. [Figure 3.6]

**Note:** The max water line is **only** for this purpose.  
**Do not pour water into the base chamber.**

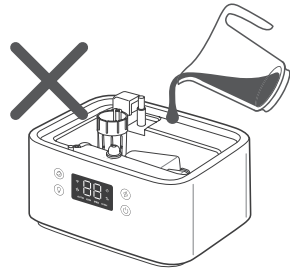

Figure 3.4

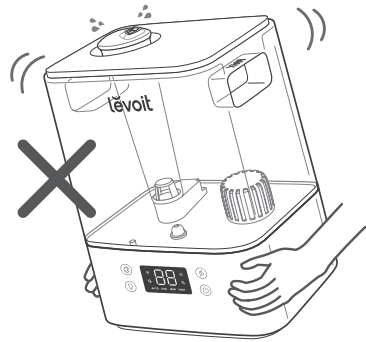

Figure 3.5

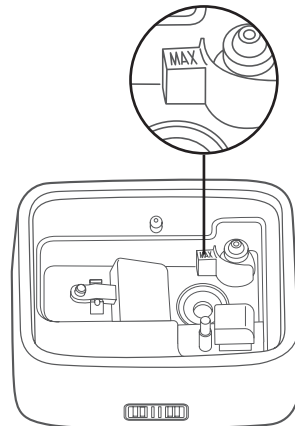

Figure 3.6

## Using the Aroma Box

Your humidifier can be used for aromatherapy.

1. Push the aroma box at the back of the base and pull it out. *[Figure 3.7]*

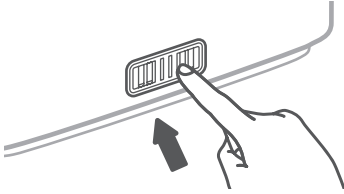

Figure 3.7

2. Put 8–10 drops of essential oil on the aroma pad. *[Figure 3.8]*

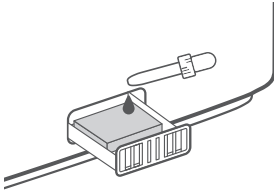

Figure 3.8

3. Place the aroma box into the humidifier.
4. Turn on the humidifier. The humidifier will automatically diffuse aroma when used.

### Note:

- **Do not** add essential oils, water treatment liquids, or third-party water filters into the water tank or base chamber. **Only** add essential oils to the aroma pad.
- The aroma pads can be cleaned and reused after diffusing essential oils (see **Cleaning the Aroma Pad**, page 20).
- The aroma is intended to be light. This humidifier is not an aroma diffuser.

# CARE & MAINTENANCE

## Note:

- All maintenance should be done on a water-resistant surface, such as a kitchen counter.
- Change the water daily to avoid bacteria growth.
- Use a tissue or cloth to clean the nozzle regularly.
- If not using the humidifier for 1 week or longer, **do not** leave water inside. Clean and dry the humidifier instead.

## Cleaning

You should clean your humidifier every week, and when you're ready to store it.

## Note:

- **Never** immerse the base in water or liquid. **Do not** place any part of the humidifier in a dishwasher.
- **Do not** use detergents to clean the humidifier.

1. Unplug the humidifier.
2. Remove and rinse the water tank cover. [Figure 4.1]

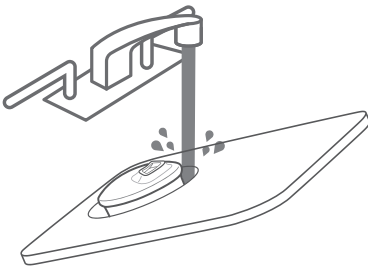

Figure 4.1

3. Remove and rinse the dust cover if necessary. [Figure 4.2]

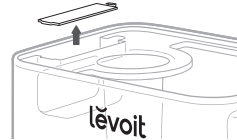

Figure 4.2

4. Remove the water tank from the base and pour out any water from the tank and base chamber. [Figure 4.3]

**Note:** When pouring out water, hold down the float to ensure that it does not fall out of the base chamber.

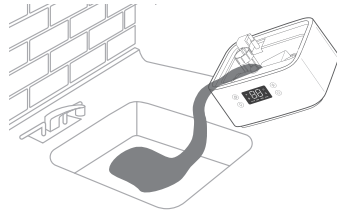

Figure 4.3

5. Remove the water filter from the tank by rotating it counterclockwise and lifting it out. [Figure 4.4]

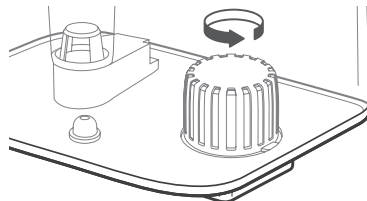

Figure 4.4



## Cleaning (cont.)

6. Rinse the tank, water filter, and base chamber with room temperature water. [Figure 4.5]

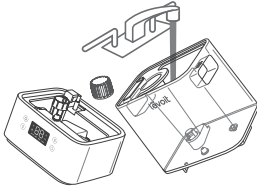

Figure 4.5

7. To descale the humidifier:

- a. Remove the water filter from the tank by rotating it counterclockwise and lifting it out. [Figure 4.6]

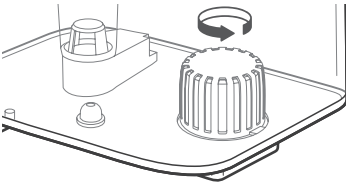

Figure 4.6

- b. Fill the tank with 3 US cups / 710 mL of distilled white vinegar. [Figure 4.7]

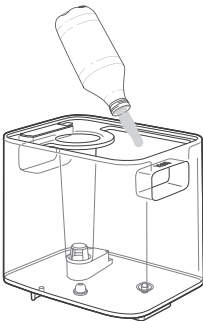

Figure 4.7

- c. Replace the tank cover and swish the vinegar around the tank. [Figure 4.8]

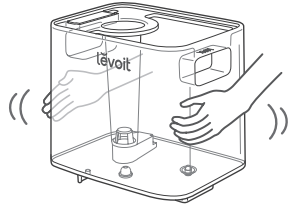

Figure 4.8

- d. Place the tank on the base and soak for 15–20 minutes. Vinegar will drain into the base chamber and loosen scale (mineral buildup) in the tank and in the base chamber (including the transducer and float). [Figure 4.9]

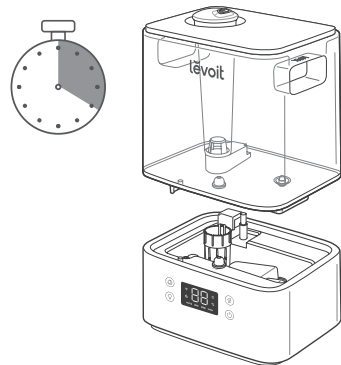

Figure 4.9

## Cleaning (cont.)

- e. Remove the tank, remove the tank cover, and pour out any vinegar. *[Figure 4.10]*

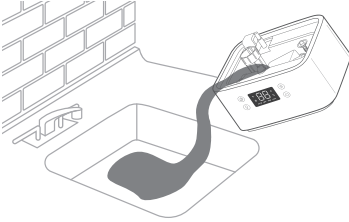

Figure 4.10

- f. Flip the tank over and remove the noise silencer. To remove the noise silencer, press the release tab and gently pull away from the humidifier. *[Figure 4.11]*

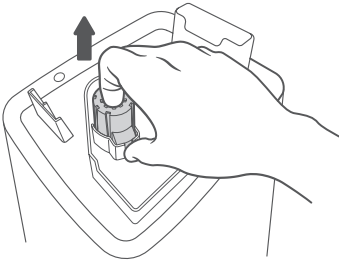

Figure 4.11

- g. Remove the float from the base chamber by pulling up the larger side of the float *[Figure 4.12]* and pulling the shaft out from the float brackets. One side of the float brackets is open (U-shaped) to allow the shaft to be removed. *[Figure 4.13]*

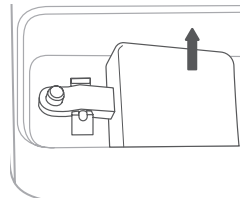

Figure 4.12

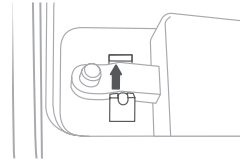

Figure 4.13

- h. Place the float, water filter, and noise silencer in a small container. Fill with enough vinegar to cover them. Soak for 15–20 minutes. *[Figure 4.14]*

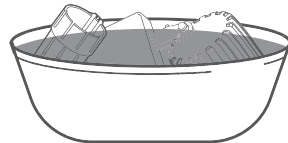

Figure 4.14

## Cleaning (cont.)

- i. Use a soft cloth and the included cleaning brush to remove scale from all parts. [Figure 4.15]

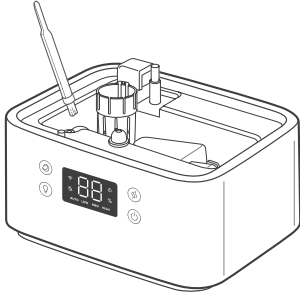

Figure 4.15

- j. Rinse all parts until any vinegar smell is completely gone. [Figure 4.16]

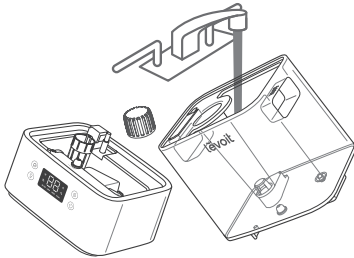

Figure 4.16

8. Dry all parts with a cloth. Make sure all parts are completely dry before reassembling or storing.

## Cleaning the Aroma Pad

1. Press the aroma box to release it from the base, and pull it out. *[Figure 4.17]*

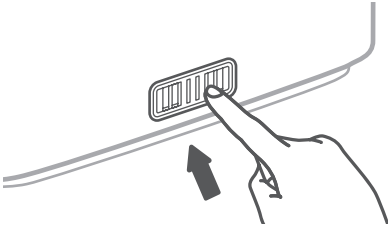

Figure 4.17

3. Dry with a clean cloth and place it back into the aroma box. *[Figure 4.19]*

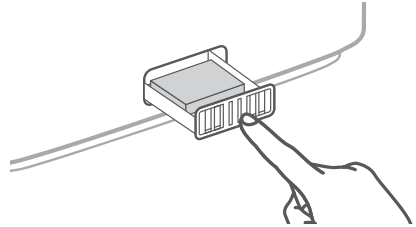

Figure 4.19

2. Remove the aroma pad and rinse under warm, running water. *[Figure 4.18]*

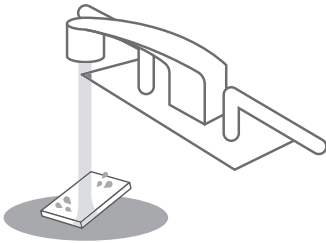

Figure 4.18

**Note:** *Do not* pour liquid cleaners or detergents into the aroma pad or box.

## Reassembling

1. Flip the water tank over and place the noise silencer back into the tank. [Figure 4.20]

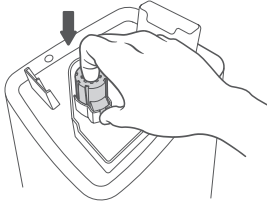

Figure 4.20

2. Place the water filter back into the tank and rotate it clockwise to secure it in place. [Figure 4.21]

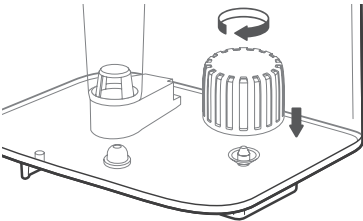

Figure 4.21

3. Place the float back into the base chamber:
  - a. Make sure the correct side of the float is facing up. [Figure 4.22]

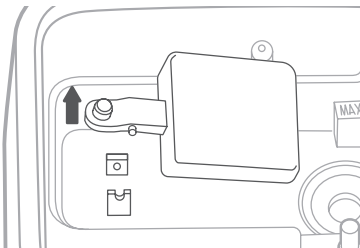

Figure 4.22

- b. Insert the smaller prong into the closed side of the float brackets. [Figure 4.23]

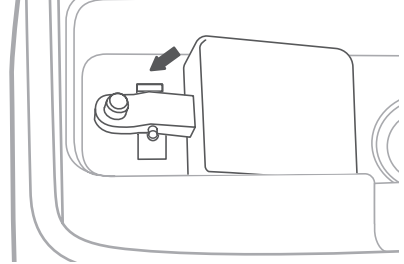

Figure 4.23

- c. Place the larger prong into the open (U-shaped) side of the float brackets.
4. Place the tank back on the base. Refill the tank, if necessary.
  5. Place the tank properly on the base and place the tank cover on the water tank.

## Storing

Follow the cleaning instructions (see page 16) and allow all parts to dry completely before storing. Store in a cool, dry location.

# TROUBLESHOOTING

Problem	Possible Solution
Humidifier doesn't turn on, or turns off unexpectedly.	Plug in the humidifier and turn it on.
	Add purified or distilled water to the water tank.
	Check to see if the humidifier is in Auto Mode. Depending on Auto Mode settings, the humidifier may automatically turn off when the humidity level is above the target level.
Little or no mist comes out.	Turn the mist level to a higher setting.
	Fill the water tank.
	There may be too much water in the base chamber. Empty the base chamber. Refill the water tank (not the base chamber) and place the water tank properly onto the base.
	Make sure the air inlet on the bottom of the base is not blocked. The humidifier should not be set on carpet or other surfaces that may block the air inlet.
	Make sure the nozzle is not blocked or clogged.
	Make sure the humidifier is on a level surface.
	The water temperature may be too low. Turn the mist level to the highest setting and let the humidifier run for a while, then adjust to the desired setting.
	If the water tank or base was washed with detergent, rinse thoroughly with clean water to remove any detergent.
Humidifier uses water too quickly.	The humidifier uses up water based on the environmental temperature and humidity. If your environment is cold and/or dry, the humidifier will run out of water faster.
Humidifier produces an unusual smell.	If the humidifier is new, unplug and rinse all parts, then place in a cool, dry place for 12 hours.
	If essential oils were placed on the aroma pad, rinse the pad under clean water and allow it to dry.
	Clean the water tank and base chamber (see <b>Care &amp; Maintenance</b> , page 16).
White dust appears around the humidifier.	We recommend using purified or distilled water to fill the humidifier. Avoid using water with high mineral content.
	Clean the humidifier (see <b>Care &amp; Maintenance</b> , page 16).

## TROUBLESHOOTING (CONT.)

Problem	Possible Solution
<b>Humidifier makes a loud or unusual noise.</b>	Make sure the water tank is properly in place (see <b>Getting Started</b> , page 8).
	Set mist level to a lower setting.
	Empty the base chamber. Refill the water tank (not the base chamber) and place the water tank properly onto the base.
	The humidifier may be malfunctioning. Stop using the humidifier and contact <b>Customer Support</b> (see page 27).
<b>Water leaks from the humidifier.</b>	Make sure the silicone sealing ring around the water outlet valve is secure.
	Avoid running the humidifier in a room with over 60% relative humidity.
	Wipe any excess water off the top and bottom of the base.
	<b>Do not</b> shake the humidifier.
	Make sure to place the humidifier on a flat, level surface.
	Check the water tank for leaks. If there are leaks, contact <b>Customer Support</b> (see page 27).
<b>Condensation forms around humidifier or windows.</b>	Humidity may be too high. Turn down the mist level, turn off the humidifier, or open a door or window to the room.
<b>Mold grows inside the humidifier.</b>	Clean the water tank and base chamber regularly (see <b>Care &amp; Maintenance</b> , page 16).
 is red.	Fill the water tank.
	Place the water tank properly on the base.
	Clean the water filter (see page 16) or replace it with a new one. To request a new water filter, contact <b>Customer Support</b> (see page 27).
<b>Essential oil has little or no smell.</b>	Add more essential oil. For best results, use pure essential oil.
<b>Display shows an incorrect humidity percentage.</b>	The room may be larger than the humidifier's effective range. Move to a room smaller than 215–505 ft <sup>2</sup> / 20–47 m <sup>2</sup> .
	Moisture may have built up inside the humidity sensor. Turn off the humidifier and allow the sensor to air dry. Make sure the nozzle is facing away from the sensor so that mist does not settle on the sensor (see diagram in <b>Getting To Know Your Smart Humidifier</b> , page 5).
<b>Display shows Error Code "E1".</b>	The humidifier is malfunctioning. Contact <b>Customer Support</b> (see page 27).

If your problem is not listed, please contact **Customer Support** (see page 27).

# VESYNC APP TROUBLESHOOTING

## Why isn't my humidifier connecting to the VeSync app?

- Make sure your phone has Bluetooth® turned on and is not currently connected to another Bluetooth device.
- During the setup process, you must be on a secure 2.4GHz Wi-Fi network. Confirm that the network is working correctly.
- Make sure the Wi-Fi password you entered is correct.
- Make sure your humidifier and phone are within 30 ft / 10 m of each other.
- Reset the humidifier by pressing and holding  for 15 seconds. Then try connecting again.

## My humidifier is offline.

- Make sure the humidifier is plugged in. The humidifier may appear to be offline if it is unplugged, or if the outlet does not have power.
- Refresh the VeSync menu by swiping down on the screen.
- Make sure your router is connected to the internet and your phone's network connection is working.
- Reset the humidifier using one of these options:
  - a. Delete the humidifier from the VeSync app. Swipe left (iOS®) or press and hold (Android), then tap **Delete**. Then reconfigure your humidifier with the VeSync app.
  - b. Press and hold  for 15 seconds. Then reconfigure your humidifier with the VeSync app.

**Note:** Power outages, internet outages, or changing Wi-Fi routers may cause your humidifier to go offline.

## The VeSync app is displaying an incorrect humidity percentage while the humidifier is turned on.

- The room may be larger than the humidifier's effective range. Move to a room smaller than 505 ft<sup>2</sup> / 47 m<sup>2</sup>.
- Moisture may have built up inside the humidity sensor. Turn off the humidifier and allow the sensor to air dry. Make sure the nozzle is facing away from the sensor so that mist does not settle on the sensor (see diagram in **Getting To Know Your Smart Humidifier**, page 5).

**If your problem is not listed**, please contact **Customer Support** (see page 27).



# FEDERAL COMMUNICATION COMMISSION INTERFERENCE STATEMENT

This device complies with Part 15 of the FCC Rules. Operation is subject to the following two conditions:

1. This device may not cause harmful interference, and
2. This device must accept any interference received, including interference that may cause undesired operation.

NOTE: This equipment has been tested and found to comply with the limits for a Class B digital device, pursuant to Part 15 of the FCC Rules. These limits are designed to provide reasonable protection against harmful interference in a residential installation. This equipment generates, uses and can radiate radio frequency energy and, if not installed and used in accordance with the instructions, may cause harmful interference to radio communications. However, there is no guarantee that interference will not occur in a particular installation. If this equipment does cause harmful interference to radio or television reception, which can be determined by turning the equipment off and on, the user is encouraged to try to correct the interference by one or more of the following measures:

- Reorient or relocate the receiving antenna.
- Increase the separation between the equipment and receiver.
- Connect the equipment into an outlet on a circuit different from that to which the receiver is connected.
- Consult the dealer or an experienced radio/TV technician for help.

**FCC Caution:** Any changes or modifications not expressly approved by the party responsible for compliance could void the user's authority to operate this equipment.

## FCC RADIATION EXPOSURE STATEMENT

This equipment complies with FCC radiation exposure limits set forth for an uncontrolled environment. End users must follow the specific operating instructions for satisfying RF exposure compliance. To maintain compliance with FCC RF exposure compliance requirements, please follow operation instructions as documented in this manual. This transmitter must not be co-located or operating in conjunction with any other antenna or transmitter. This equipment should be installed and operated with a minimum distance of 20 cm between the radiator and your body. The availability of some specific channels and/or operational frequency bands are country dependent and are firmware programmed at the factory to match the intended destination. The firmware setting is not accessible by the end user.

# WARRANTY INFORMATION

<b>Product</b>	VeSync Classic 300S Ultrasonic Smart Humidifier
<b>Models</b>	Classic 300S, LUH-A601S-WUSB
<i>For your own reference, we strongly recommend that you record your order ID and date of purchase.</i>	
<b>Date of Purchase</b>	
<b>Order ID</b>	

## Terms & Policy

Arovast Corporation (“Arovast”) warrants this product to the original purchaser to be free from defects in material and workmanship, under normal use and conditions, for a period of 2 years from the date of original purchase.

Arovast agrees, at our option during the warranty period, to repair any defect in material or workmanship or furnish an equal product in exchange without charge, subject to verification of the defect or malfunction and proof of the date of purchase.

There is no other express warranty. This warranty does not apply:

- If the product has been modified from its original condition;
- If the product has not been used in accordance with directions and instructions in the user manual;
- To damages or defects caused by accident, abuse, misuse or improper or inadequate maintenance;
- To damages or defects caused by service or repair of the product performed by an unauthorized service provider or by anyone other than Arovast;
- To damages or defects occurring during commercial use, rental use, or any use for which the product is not intended;
- To damages or defects exceeding the cost of the product.

Arovast will not be liable for indirect, incidental, or consequential damages in connection with the use of the product covered by this warranty.

This warranty extends only to the original consumer purchaser of the product and is not transferable to any subsequent owner of the product regardless of whether the product is transferred during the specified term of the warranty.

This warranty does not extend to products purchased from unauthorized sellers. Arovast’s warranty extends only to products purchased from authorized sellers that are subject to Arovast’s quality controls and have agreed to follow its quality controls.

All implied warranties are limited to the period of this limited warranty.

This warranty gives you specific legal rights and you may also have other rights which vary from state to state. Some states do not allow the exclusion or limitation of incidental or consequential damages, so the above limitation or exclusion may not apply to you.

If you discover that your product is defective within the specified warranty period, please contact Customer Support via [support@levoit.com](mailto:support@levoit.com). **DO NOT** dispose of your product before contacting us. Once our Customer Support Team has approved your request, please return the product with a copy of the invoice and order ID.

Every Levoit product automatically includes a 2-year warranty. To make the customer support process quick and easy, register your product online at [www.levoit.com/warranty](http://www.levoit.com/warranty).

This warranty is made by:

Arovast Corporation  
1202 N. Miller St., Suite A  
Anaheim, CA 92806

# CUSTOMER SUPPORT

If you have any questions or concerns about your new product, please contact our helpful Customer Support Team.

## **Distributed by Arovast Corporation**

1202 N. Miller St., Suite A  
Anaheim, CA 92806

**Email:** support@levoit.com

**Toll-Free:** (888) 726-8520

## **Support Hours**

Mon–Fri, 9:00 am–5:00 pm PST/PDT

\*Please have your order invoice and order ID ready before contacting Customer Support.

# ATTRIBUTIONS

Apple App Store is a trademark of Apple Inc.

Google, Android, and Google Play are trademarks of Google LLC.

Wi-Fi® is a registered trademark of Wi-Fi Alliance®.

Amazon, Alexa and all related logos are trademarks of Amazon.com, Inc. or its affiliates.

iOS is a registered trademark of Cisco Systems, Inc. and/or its affiliates in the United States and certain other countries.

The Bluetooth® word mark and logos are registered trademarks owned by Bluetooth SIG, Inc. and any use of such marks by Arovast Corporation is under license. Other trademarks and trade names are those of their respective owners.

lěvoit<sup>®</sup>



/LEVOITLIFESTYLE



/LEVOIT



/LEVOIT



/LEVOIT



LEVOIT.COM