



## USER MANUAL

# Classic 300 Lite Ultrasonic Cool Mist Humidifier

Product Series: Classic 300

Model: LUH-A603-WUS

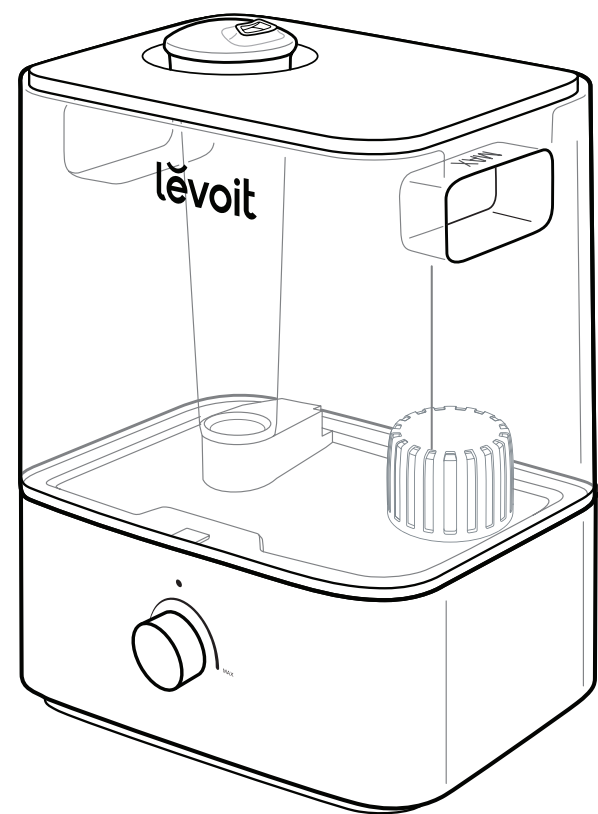

### Questions or Concerns?

Please contact us Mon–Fri, 9:00 am–5:00 pm PST/PDT at [support@levoit.com](mailto:support@levoit.com) or at **(888) 726-8520**.

# READ AND SAVE THESE INSTRUCTIONS

## SAFETY INFORMATION

To reduce the risk of fire, electric shock, or other injury, follow all instructions and safety guidelines.

### General Safety

- **Only** use the humidifier as described in this manual.
- Place the humidifier and cord so that it will not be knocked over.
- **Do not** place near large pieces of furniture or in high-traffic areas.
- When not in use, turn the humidifier off and disconnect from power by removing the plug from the outlet.
- **Do not** use the humidifier in wet environments.
- Keep the humidifier out of reach from children.
- **Do not** open the base or remove the water level sensor for self-servicing.
- **Always** unplug your humidifier from the power outlet before cleaning your humidifier or detaching the water tank from the humidifier base.
- **Always** make sure to place the humidifier on a flat, level surface before operation.
- **Only** fill the water tank with clean water. **Never** fill the water tank with any other liquids.
- **Do not** place the humidifier near sources of heat, such as stovetops, ovens, or radiators.
- **Do not** place the humidifier directly on floors, carpets, or rugs.
- **Do not** use other items as replacement parts for this humidifier.
- **Do not** cover the nozzle while the humidifier is on. Doing so may damage the humidifier.
- Remove the water tank from the base before moving the humidifier.
- **Do not** immerse the humidifier base, power cord, or plug in water.
- If the humidifier is damaged or is not functioning properly, stop using it and contact **Customer Support** immediately (see page 10).
- Supervise children when they are near the humidifier.
- Children should not clean or perform maintenance on the humidifier without supervision.
- Children should be supervised to ensure that they do not play with the humidifier.
- This humidifier is not to be used by persons (including children) with reduced physical, sensory, or mental capacities, or lack of experience and knowledge, unless they have been given supervision or instruction concerning the use of the appliance by a person responsible for the safety.
- Household use **only**. Not for commercial use.

### SAFETY INFORMATION (CONT.)

#### Caution: Risk of Leaks and Electric Shock

**Do not** add essential oils or supplemental water treatment liquids into the water tank or base chamber. This will damage the humidifier and cause leaks.

### Power & Cord

- Ensure that the plug fits properly into a polarized socket.
- **Do not** handle the power cord or plug with wet hands. Keep the plug and power cord away from liquids.
- Your humidifier has a polarized plug (one prong is wider than the other), which fits into a polarized outlet only one way. This is a safety feature to reduce the risk of electric shock. If the plug does not fit, reverse the plug. If it still does not fit, **do not** use the plug in that outlet. **Do not** bypass this safety feature.
- If the power supply cord is damaged, it must be replaced by Arovast Corporation or similarly qualified persons in order to avoid an electric or fire hazard. Please contact **Customer Support**.

### Package Contents

- 1 × Ultrasonic Humidifier
- 2 × Water Filter Sponge (1 Pre-Installed)
- 1 × Cleaning Brush
- 1 × User Manual

### Specifications

Power Supply	AC 120V, 60Hz
Rated Power	25W
Water Tank Capacity	1.58 gal / 6 L
Max Run Time	Up to 60 hours on minimum mist setting <i>Note: The humidifier may run for a longer or shorter time depending on the environmental temperature and humidity.</i>
Noise Level	≤ 30dB
Effective Range	215–505 ft <sup>2</sup> / 20–47 m <sup>2</sup>
Dimensions	9.7 x 8.1 x 13.4 in / 24.5 x 20.5 x 34 cm
Weight	4.2 lb / 1.9 kg

### GETTING TO KNOW YOUR HUMIDIFIER

- A. Nozzle
- B. Water Tank Cover
- C. Dust Cover
- D. Mist Tube
- E. Water Tank
- F. Base
- G. Refill Indicator Light
- H. Control Knob
- I. Max Water Line (Tank)
- J. Water Tank Handles
- K. Water Filter
- L. Power Cord
- M. Float
- N. Float Brackets
- O. Max Water Line (Base)
- P. Secondary Float
- Q. Transducer
- R. Air Outlet
- S. Air Inlet
- T. Feet
- U. Water Outlet Valve Assembly
- V. Water Outlet Valve
- W. Noise Silencer
- X. Cleaning Brush

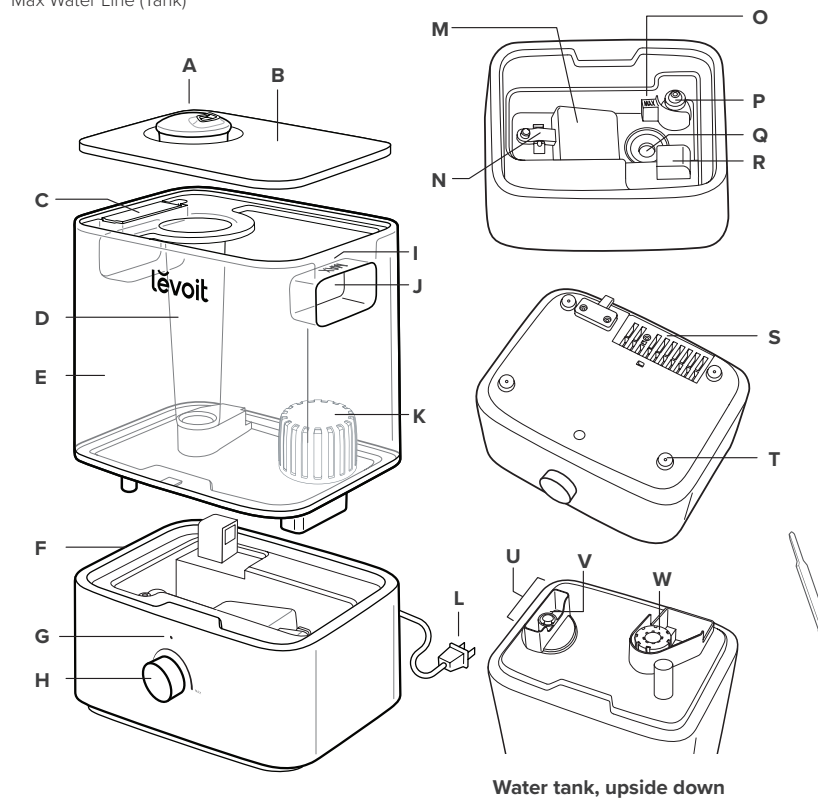

### CONTROLS

#### Control Knob

- Rotate clockwise to turn on the humidifier and to adjust the mist level.
- Rotate counterclockwise to turn off the humidifier.

**Note:** There is a clicking sound when the humidifier turns on/off.

#### Refill Indicator Light

- The red light turns on when the water tank is empty. Refill the water tank (see page 5).
- The red light turns off when the water tank is filled.

### GETTING STARTED

1. Remove all packaging. Take the water tank off of the base and **remove all tape**.
2. Clean the humidifier before first use (see page 7).

**Note:** Check to make sure that the water filter is correctly in place. If not, then rotate the filter clockwise to secure it in place. [Figure 1.1]

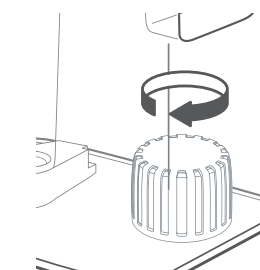

Figure 1.1

3. Choose a hard, flat location for the humidifier at least 12 inches / 30 cm away from any walls. The surface must be water-resistant. [Figure 1.2]
4. Mist should be directed away from walls, furniture, bedding, and appliances.

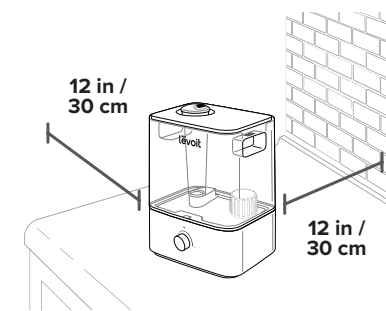

Figure 1.2

### Filling & Refilling

1. Remove the water tank cover. Use the handles to remove the tank from the base. Fill the tank with room-temperature water. [Figure 1.3]

#### Note:

- We recommend using purified or distilled water to fill the tank.
- **Do not** fill past the tank's max water line.

2. Replace the water tank cover and place the tank back on the base. [Figure 1.4]

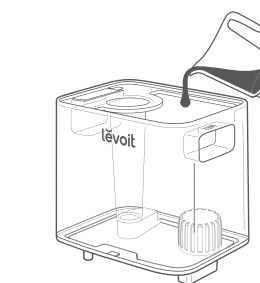

Figure 1.3

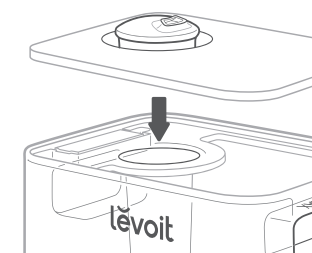

Figure 1.4

## CAUTION

- **Do not** add water directly into the base chamber. [Figure 1.5]
- **Do not** add water through the mist tube. [Figure 1.6]
- **Do not** add essential oils or supplemental water treatment liquids into the humidifier.
- **Do not** use third-party water filters.

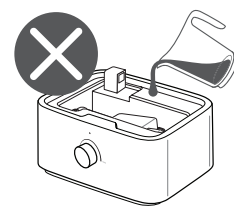

Figure 1.5

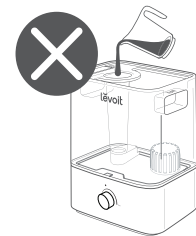

Figure 1.6

## USING YOUR HUMIDIFIER

1. Rotate the Control Knob clockwise to turn the humidifier on. Adjust the knob to your desired mist level.
2. Rotate the nozzle to adjust the direction of the mist. [Figure 2.1]
3. When your room has reached your preferred humidity level, turn the humidifier to a lower setting, or turn it off.
4. Rotate the Control Knob counterclockwise to turn the humidifier off.

**Note:** If there is no water in the tank or the tank is removed, the humidifier will stop misting and the Refill Indicator Light will turn on. Refill the tank and place it on the base.

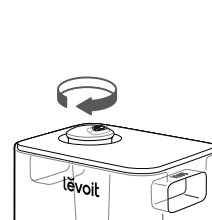

Figure 2.1

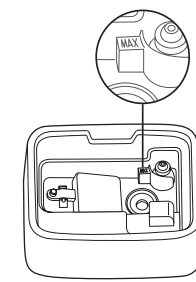

Figure 2.2

## Important Tips

Your humidifier must have the correct level of water in the base chamber to work properly. If there is too much water in the base chamber, the humidifier cannot create mist.

- **Only** add water to the water tank.
- Avoid moving or shaking the humidifier.
- Before moving the humidifier, turn it off, unplug it, and remove the water tank.
- If your humidifier doesn't produce mist correctly, check the max water line to see if there is too much water in the base chamber. Pour out extra water. [Figure 2.2]

**Note:** The max water line is **only** for this purpose.

## CARE & MAINTENANCE

- All maintenance should be done on a water-resistant surface.
- Change the water daily to avoid bacteria growth.
- Use a tissue or cloth to clean the nozzle regularly.
- If not using the humidifier for 3 days or longer, **do not** leave water inside.

## Cleaning

You should clean your humidifier every 3 days, and when you're ready to store it.

### Note:

- **Never** immerse the base in water or liquid. **Do not** place any part of the humidifier in a dishwasher.
- **Do not** use detergents to clean the humidifier.

1. Unplug the humidifier. Remove and rinse the water tank cover and dust cover. [Figure 3.1]
2. Remove the water tank and pour out any water from the tank and base chamber.

**Note:** When pouring out water, hold down the float to ensure that it does not fall out of the base chamber.

3. Remove the water filter from the tank by rotating it counterclockwise. [Figure 3.2]
4. Rinse the tank, water filter, and base chamber with room temperature water.

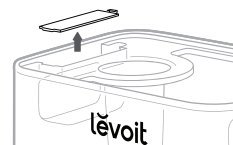

Figure 3.1

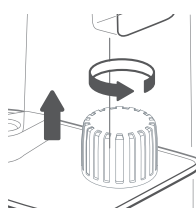

Figure 3.2

## Descaling Your Humidifier

1. Remove the water filter from the tank by rotating it counterclockwise.
2. Fill the tank with 3 US cups / 710 mL of distilled white vinegar.
3. Replace the tank cover and swish the vinegar around the tank. [Figure 3.3]
4. Place the tank on the base and soak for 15–20 minutes. Vinegar will drain into the base chamber and loosen scale (mineral buildup). [Figure 3.4]
5. Pour out any vinegar and flip the tank over. Remove the noise silencer by pressing the release tab and gently pulling it off. [Figure 3.5]

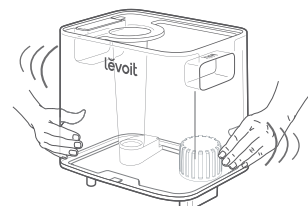

Figure 3.3

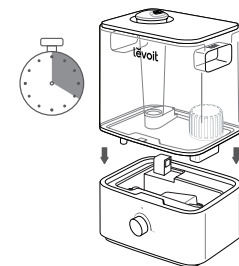

Figure 3.4

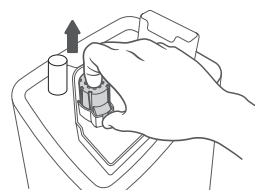

Figure 3.5

6. Remove the float from the base chamber by pulling up the larger side of the float [Figure 3.6] and pulling the shaft out from the float brackets. One side of the brackets is open (U-shaped) to allow removal. [Figure 3.7]

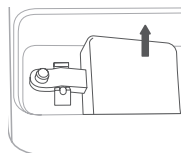

Figure 3.6

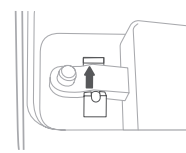

Figure 3.7

7. Place the float, water filter, and noise silencer in a container. Fill with enough vinegar to cover them. Soak for 15–20 minutes.
8. Use the cleaning brush and a soft cloth to remove scale from all parts.
9. Rinse all parts until any vinegar smell is completely gone.
10. Completely dry all parts with a cloth before reassembling.

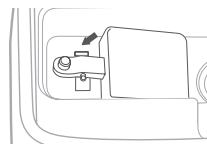

Figure 3.8

## Reassembling

1. Flip the water tank over and place the noise silencer back into the tank.
2. Place the water filter back into the tank and rotate it clockwise to secure it in place.
3. Place the float back into the base chamber:
  - a. Make sure the correct side of the float is facing up.
  - b. Insert the smaller prong into the closed side of the float brackets. [Figure 3.8]
  - c. Place the larger prong into the open (U-shaped) side of the float brackets.
4. Place the tank on the base and place the cover on top.

## Storing

Follow the cleaning instructions (see page 7) and allow all parts to dry completely before storing. Store in a cool, dry location.

## FEDERAL COMMUNICATION COMMISSION INTERFERENCE STATEMENT – PART 18

This device complies with part 18 of the FCC Rules.

This equipment generates and uses ISM frequency energy and if not installed and used properly, that is in strict accordance with the manufacturer's instructions, may cause interference to radio and television reception. It has been type tested and found to comply with limits for an ISM Equipment pursuant to part 18 of FCC Rules, which are designed to provide reasonable protection against such interference in a residential installation. However, there is no guarantee that interference will not occur in a particular installation. If this equipment does cause interference to radio or television reception, which can be determined by tuning the equipment off and on, the user is encouraged to try to correct the interference by one or more of the following:

- Reorient the receiving antenna of radio or television.
- Relocate the equipment with respect to the receiver.
- Move the equipment away from the receiver.
- Plug the equipment into a different outlet so that the equipment and receiver are on different branch circuits.

Conduct only the user maintenance found in this manual. Other maintenance and servicing can cause harmful interference and can void the required FCC compliance. The manufacturer is not responsible for any radio or TV interference cause by unauthorized modification to the equipment. It is the responsibility of the user to correct such interference.

## FCC SDOC SUPPLIER'S DECLARATION OF CONFORMITY

Aroavast Corporation hereby declares that this equipment is in compliance with the FCC Part 18 Subpart B. The declaration of conformity may be consulted in the support section of our Web site, accessible from [www.levoit.com](http://www.levoit.com)

## TROUBLESHOOTING

Problem	Possible Solution
<b>Little or no mist comes out.</b>	Turn the mist level to a higher setting.
	There may be too much water in the base chamber. Empty the base chamber. Refill the water tank (not the base chamber) and place the water tank properly onto the base.
	Make sure the air inlet on the bottom of the base is not blocked. The humidifier should not be set on carpet or other surfaces that may block the air inlet.
	Make sure the nozzle is not blocked or clogged.
<b>Humidifier produces an unusual smell.</b>	If the humidifier is new, unplug and rinse all parts, then place in a cool, dry place for 12 hours.
	Clean the water tank and base chamber (see <b>Care &amp; Maintenance</b> , page 6).
<b>Condensation forms around humidifier or windows.</b>	Humidity may be too high. Turn down the mist level, turn off the humidifier, or open a door or window in the room.
<b>Mold grows inside the humidifier.</b>	Clean the water tank and base chamber regularly (see <b>Care &amp; Maintenance</b> , page 6).
<b>Refill Indicator Light turns on.</b>	Fill the water tank.
	Place the water tank properly on the base.
	Clean the water filter (see page 7) or replace it with a new one. To request a new water filter, contact <b>Customer Support</b> (see page 10).

A1-01.00\_D\_22A06\_us

## WARRANTY INFORMATION

<b>Product</b>	Classic 300 Lite Ultrasonic Cool Mist Humidifier
<b>Model</b>	LUH-A603-WUS
<i>For your own reference, we strongly recommend that you record your order ID and date of purchase.</i>	
<b>Date of Purchase</b>	
<b>Order ID</b>	

This warranty does not extend to products purchased from unauthorized sellers. Aroavast's warranty extends only to products purchased from authorized sellers that are subject to Aroavast's quality controls and have agreed to follow its quality controls.

All implied warranties are limited to the period of this limited warranty.

This warranty gives you specific legal rights and you may also have other rights which vary from state to state. Some states do not allow the exclusion or limitation of incidental or consequential damages, so the above limitation or exclusion may not apply to you.

If you discover that your product is defective within the specified warranty period, please contact Customer Support via [support@levoit.com](mailto:support@levoit.com). **DO NOT** dispose of your product before contacting us. Once our Customer Support Team has approved your request, please return the product with a copy of the invoice and order ID.

Every Levoit product automatically includes a 2-year warranty. To make the customer support process quick and easy, register your product online at [www.levoit.com/warranty](http://www.levoit.com/warranty).

There is no other express warranty. This warranty does not apply:

- If the product has been modified from its original condition;
- If the product has not been used in accordance with directions and instructions in the user manual;
- To damages or defects caused by accident, abuse, misuse or improper or inadequate maintenance;
- To damages or defects caused by service or repair of the product performed by an unauthorized service provider or by anyone other than Aroavast;
- To damages or defects occurring during commercial use, rental use, or any use for which the product is not intended;
- To damages or defects exceeding the cost of the product.

Aroavast will not be liable for indirect, incidental, or consequential damages in connection with the use of the product covered by this warranty.

This warranty extends only to the original consumer purchaser of the product and is not transferable to any subsequent owner of the product regardless of whether the product is transferred during the specified term of the warranty.

This warranty is made by:

Aroavast Corporation  
1202 N. Miller St., Suite A  
Anaheim, CA 92806

## CUSTOMER SUPPORT

If you have any questions or concerns about your new product, please contact our helpful Customer Support Team.

**Aroavast Corporation**  
1202 N. Miller St., Suite A  
Anaheim, CA 92806

**Email:** [support@levoit.com](mailto:support@levoit.com)  
**Toll-Free:** (888) 726-8520

## Support Hours

Mon–Fri, 9:00 am–5:00 pm PST/PDT

\*Please have your order invoice and order ID ready before contacting Customer Support.