

Overview

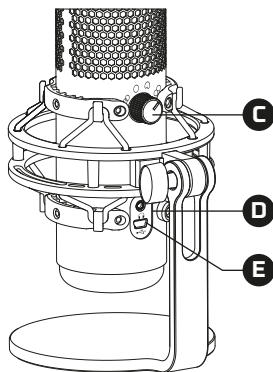

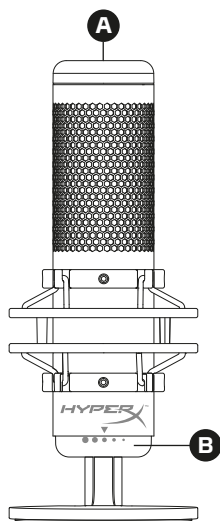





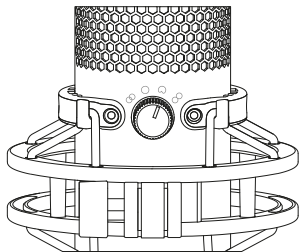

- A** Tap-to-Mute Sensor
- B** Gain Control Knob
- C** Polar Pattern Knob
- D** Headphone Jack
- E** USB Cable Port
- F** USB Cable
- G** Mount Adapter*

* Supports both 3/8" and 5/8" thread sizes

Selecting a Polar Pattern



SYMBOL	SOUND DIRECTION	POLAR PATTERN
		Stereo
		Omnidirectional
		Cardioid
		Bidirectional

Adjusting Gain Control

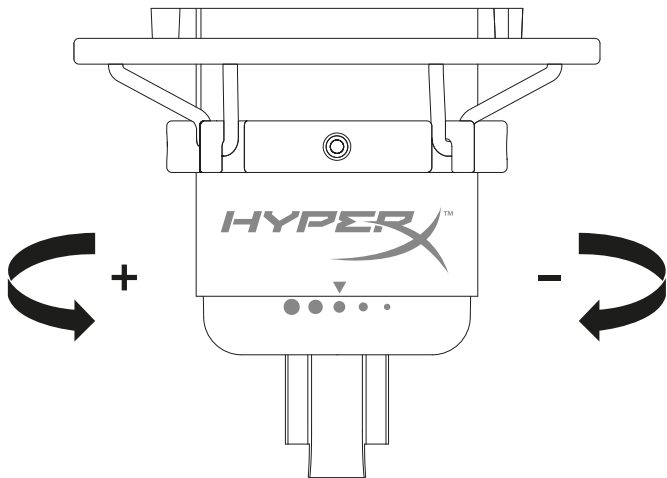

Using PC or PS4™

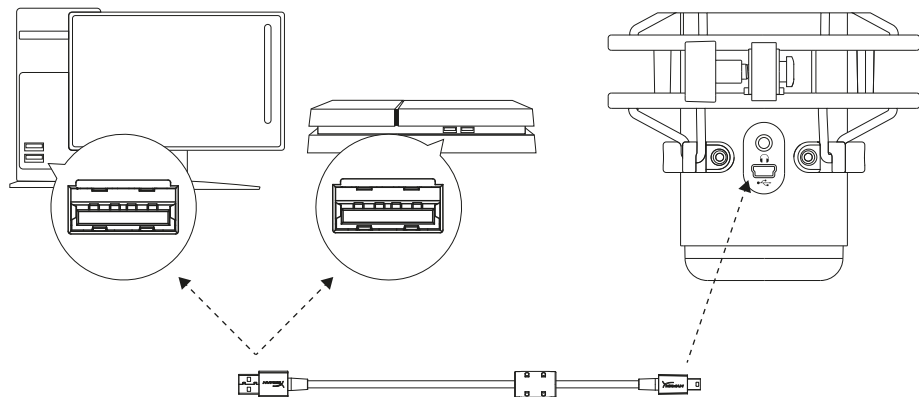

Connecting Headphones

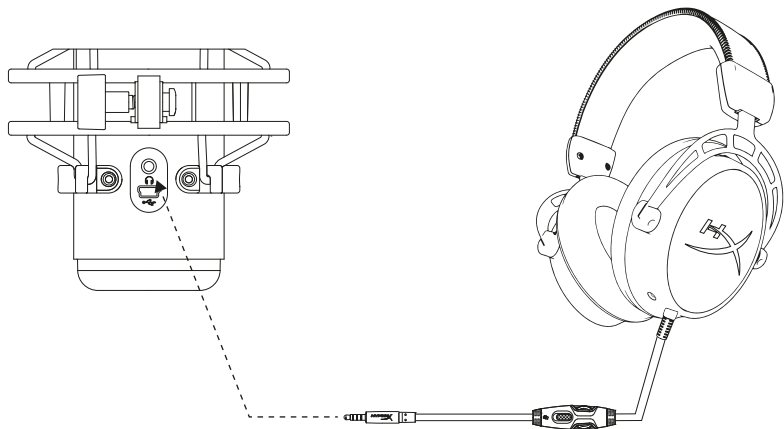

Questions or setup issues?

Contact the HyperX support team or see user manual at: hyperxgaming.com/support

ENGLISH

Overview

A - Polar Pattern Knob

B - Gain Control Knob

C - Tap-to-Mute Sensor

D - Headphone Jack









E - USB Cable Port

F - USB Cable

G - Mount Adapter*

*Supports both 3/8" and 5/8" thread sizes

Selecting a Polar Pattern

SYMBOL	SOUND DIRECTION	POLAR PATTERN
		Stereo
		Omnidirectional
		Cardioid
		Bidirectional

Adjusting Gain Control

Using PC or PS4™

Connecting Headphones

Questions or setup issues?

Contact the HyperX support team or see user manual at:
hyperxgaming.com/support

FRANÇAIS

Présentation

A - Capteur tactile Coupure audio

B - Bouton Contrôle de gain

C - Bouton Diagramme polaire

D - Jack du casque









E - Port de câble USB

F - Câble USB

G - Adaptateur de support*

*Compatible avec les filetages 3/8 et 5/8 de pouce

Sélection d'un diagramme polaire

SYMBOLE	DIRECTION DU SON	DIAGRAMME POLAIRE
		Stéréo
		Omnidirectionnel
		Cardioïde
		Bidirectionnel

Réglage du contrôle de gain

Utilisation avec PC ou PS4™

Connexion du casque

Questions ou problèmes de configuration?









Contactez l'équipe d'assistance HyperX ou consultez le manuel
d'utilisation sur :
hyperxgaming.com/support

ITALIANO

Descrizione generale del prodotto

- A** - Sensore "Tap-to-Mute"
 - B** - Manopola controllo del guadagno
 - C** - Manopola pattern polare
 - D** - Jack cuffie
 - E** - Porta per cavo USB
 - F** - Cavo USB
 - G** - Adattatore per attacco*
- *Supporta filettature da 3/8" e 5/8"

Selezione di un pattern polare

SIMBOLO	DIREZIONE DELL'AUDIO	PATTERN POLARE
		Stereo
		Omnidirezionale
		Cardioide
		Bidirezionale

Regolazione del controllo del guadagno

Utilizzo con PC o PS4™

Collegamento delle cuffie

Domande o dubbi sulla configurazione?









Contattate il team di supporto HyperX, oppure consultate il manuale d'uso all'indirizzo:
hyperxgaming.com/support

DEUTSCH

Übersicht

- A** - Tippen-zum-Stummschalten-Sensor
 - B** - Verstärkungsregel-Knopf
 - C** - Richtcharakteristik-Knopf
 - D** - Kopfhöreranschluss
 - E** - USB-Kabelanschluss
 - F** - USB-Kabel
 - G** - Montageadapter*
- *Unterstützt sowohl 3/8"- als auch 5/8"-Gewindegrößen

Auswählen einer Richtcharakteristik

SYMBOL	SOUND-RICHTUNG	RICHTCHARAKTERISTIK
		Stereo
		Omnidirektional
		Kardioid
		Bidirektional

Anpassen der Verstärkungsregelung

Verwenden von PC oder PS4™

Anschließen der Kopfhörer

Fragen oder Probleme bei der Einrichtung?

Wende Dich an das HyperX Support-Team oder sieh hier in der Bedienungsanleitung nach:
hyperxgaming.com/support

POLSKI

Prezentacja

A - Czujnik wyciszania dotykaniem

B - Pokrętko wzmocnienia

C - Pokrętko wzorca polaryzacji

D - Gniazdo słuchawkowe









E - Gniazdo kabla USB

F - Kabel USB

G - Adapter do mocowania*

*Pasują gwinty 3/8" i 5/8"

Wybór wzorca polaryzacji

SYMBOL	KIERUNEK DŹWIĘKU	WZORZEC POLARYZACJI
		Stereo
		Wszekierunkowy
		Kardioidalny
		Dwukierunkowy

Regulacja wzmocnienia

W przypadku używania PC lub PS4™

Podłączanie słuchawek

Pytania? Problemy z konfiguracją?

Skontaktuj się z zespołem pomocy technicznej HyperX lub przeczytaj podręcznik użytkownika na stronie: hyperxgaming.com/support

ESPAÑOL

Descripción general

A - Sensor Pulse-para-silenciar

B - Perilla del control de ganancia

C - Perilla del patrón polar

D - Conector de audífonos





E - Puerto para cable USB

F - Cable USB

G - Adaptador de montaje*

*Admite tamaños de rosca de 3/8" y 5/8"

Seleccionar un patrón polar

SÍMBOLO	DIRECCIÓN DEL SONIDO	PATRÓN POLAR
		Estéreo
		Omnidireccional
		Cardioide
		Bidireccional

Ajustar control de ganancia

Usar con PC o PS4™

Conectar los audífonos

¿Tienes alguna pregunta o consulta sobre la instalación?

Comunicate con el equipo de soporte de HyperX o consulta el manual del usuario en: hyperxgaming.com/support

PORTUGUÊS

Visão geral

A - Sensor de toque para silenciar

B - Botão de Controle de Volume

C - Botão de Padrão Polar

D - Entrada do fone de ouvido









E - Porta do cabo USB

F - Cabo USB

G - Adaptador de montagem*

*Compatível com tamanhos de fio de 3/8 pol e 5/8 pol

Selecionando um Padrão Polar

SÍMBOLO	DIREÇÃO DO SOM	PADRÃO POLAR
		Estéreo
		Omnidirecional
		Cardioide
		Bidirecional

Ajustando o controle do volume

Usando PC ou PS4™

Conectando os fones de ouvido

Dúvidas ou problemas na instalação?

Contate a equipe de suporte HyperX ou consulte o manual do usuário em:

hyperxgaming.com/support

ČEŠTINA

Přehled

A - Senzor vypnutí dotykem

B - Knoflík pro ovládání zesílení

C - Knoflík pro výběr směrové charakteristiky

D - Zdíčka pro připojení sluchátek









E - Port pro USB kabel

F - USB kabel

G - Montážní adaptér*

*Umožňuje použití závitu o rozměru 3/8" i 5/8"

Výběr směrové charakteristiky

SYMBOL	SMĚR ZVUKU	SMĚROVÁ CHARAKTERISTIKA
		Stereo
		Všesměrový
		Kardioidní
		Dvousměrový

Ovládání zesílení

Použití PC nebo PS4™

Připojení sluchátek

Máte dotazy nebo problémy s nastavením?

Kontaktujte tým podpory HyperX nebo si přečtěte uživatelskou příručku na adrese:

hyperxgaming.com/support

РУССКИЙ

Описание

A - Сенсорный датчик отключения звука

B - Кнопка регулировки усиления

C - Кнопка диаграммы направленности

D - Разъем для наушников

E - Порт для USB-кабеля

F - USB-кабель

G - Переходник-крепление*

*Подходит для размеров резьбы 3/8" и 5/8"

Выбор диаграммы направленности

ОБОЗНАЧЕНИЕ	НАПРАВЛЕНИЕ ЗВУКА	ДИАГРАММА НАПРАВЛЕННОСТИ
		Стерео
		Всенаправленная
		Кардиоидная
		Двусторонняя

Регулировка усиления

Использование с ПК или PS4™

Подключение наушников

Вопросы или проблемы?

Свяжитесь с командой технической поддержки HyperX или обратитесь к руководству пользователя по адресу: hyperxgaming.com/support

繁體中文

概觀

A - 觸控式靜音控制

B - 增益控制旋鈕

C - 指向性型式旋鈕

D - 耳機插孔









E - USB 線連接埠

F - USB 線

G - 安裝轉接頭*

*支援 3/8" 和 5/8" 螺紋尺寸

選擇指向性型式

符號	收音方向	指向性型式
		立體聲
		全向性
		心型
		雙指向

調整增益控制

使用電腦或PS4™

連接麥克風

有任何安裝或使用問題？

請聯絡 HyperX 支援團隊或參閱使用者手冊，網址為：
hyperxgaming.com/support

简体中文

概述

A - 点击静音传感器

B - 增益控制旋钮

C - 极性旋钮

D - 耳机插孔









E - USB 电缆端口

F - USB 连接线

G - 底座适配器*

*支持 3/8" 和 5/8" 螺纹规格

选择一种极性模式

符号	声音方向	极性模式
		立体声
		全指向
		定向
		双向

调节增益控制

使用PC或PS4™

连接耳机

存有疑问或遇到设置问题？

请联系 HyperX 支持团队，或者参阅我们的用户手册：

hyperxgaming.com/support

日本語

概要

A - タッチ式ミュートセンサー

B - 利得制御ノブ

C - 極性パターンノブ

D - ヘッドホンジャック









E - USB ケーブルポート

F - USB ケーブル

G - マウントアダプター*

*3/8 インチネジと 5/8 インチネジを両方のサイズをサポートします

極性パターンの選択

シンボル	音方向	極性パターン
		ステレオ
		無指向
		カーディオイド
		双方向

利得制御の調整

PCまたはPS4™の使用

ヘッドホンの接続

ご質問、またはセットアップに問題がありますか？









HyperX サポートチームにご連絡ください。または、以下のサイトでユーザーマニュアルをご参照ください。 hyperxgaming.com/support

عربي

نظرة عامة

- A** - مستشعر الضغط لکنم الصوت
 - B** - مقبض التحكم في مستوى الصوت
 - C** - مقبض عطف القطبية
 - D** - مقبس سماعة الأذن
 - E** - منفذ كابل USB
 - F** - كابل USB
 - G** - مهائن التركيب*
- يدعم كلاً من مقاسات السلوك 3/8 بوصة و 5/8 بوصة

تحديد عطف القطبية

رمز	اتجاه الصوت	نمط القطبية
		استيريو
		أحادي الاتجاه
		قلبي الشكل
		ثنائي الاتجاه

ضبط التحكم في الكسب

استخدام كمبيوتر شخصي أو PS4™

توصيل سماعات الأذن









أي أسئلة أو مشكلات في الإعدادات؟
اتصل بفريق دعم HyperX أو راجع دليل المستخدم على:
hyperxgaming.com/support

ROMÂNĂ

Prezentare generală

- A** - Senzor pentru dezactivarea sunetului prin atingere
 - B** - Buton de control al amplificării
 - C** - Buton țipar polar
 - D** - Mufă pentru căști
 - E** - Port pentru cablu USB
 - F** - Cablu USB
 - G** - Adaptor suport*
- *Compatibil cu filetele de 3/8" și 5/8"

Selectarea unui țipar polar

SIMBOL	DIRECȚIA SUNETULUI	TIPAR POLAR
		Stereo
		Omnidirecțional
		Cardioid
		Bidirecțional

Reglarea controlului amplificării

Utilizarea cu PC sau PS4™

Conectarea căștilor

Aveți întrebări sau probleme legate de instalare?









Contactați echipa de asistență HyperX sau consultați manualul de utilizare la adresa:
hyperxgaming.com/support

SLOVENŠČINA

Pregled

- A - Tipalo dotika za utišanje zvoka
 - B - Gumb za upravljanje pridobivanja
 - C - Gumb za polarni vzorec
 - D - Vtič za slušalke
 - E - Vrata za USB kabel
 - F - Kabel USB
 - G - Adapter za vgradnjo*
- *Podpira velikosti navoja 3/8 "in 5/8"

Izbira polarnega vzorca

SIMBOL	SMER ZVOKA	POLARNI VZOREC
		Stereo
		Vsesmerno
		Kardiod
		Dvosmerno

Nastavljanje kontrole Gain

Uporaba PC ali PS4™

Povezovanje slušalk

Vprašanja ali težave pri namestitvi?

Obrnite se na ekipo za podporo HyperX ali si oglejte uporabniški priročnik na:
hyperxgaming.com/support

HyperX is a division of Kingston.

THIS DOCUMENT SUBJECT TO CHANGE WITHOUT NOTICE

©2020 Kingston Technology Corporation, 17600 Newhope Street, Fountain Valley, CA 92708 USA.

All rights reserved. All registered trademarks and trademarks are the property of their respective owners.