

KEURIG®

**K·Cafe®
SMART**
Use & Care Guide

Get the most from your
new Keurig® brewer



Get connected with the Keurig® app.

You will need this to set up and control your brewer.

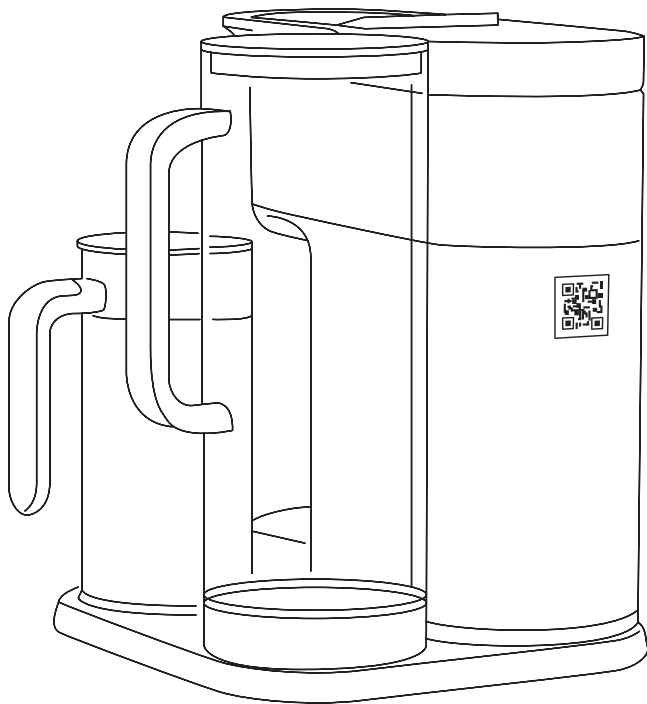

1

SCAN

the QR code
on the back of the brewer:

Use the camera on your smartphone to scan the **QR code** to download the app and get started, or download the Keurig® app in the App Store.



App Store® is a service mark of Apple Inc.
Google Play and the Google Play logo are trademarks of Google LLC.

Connect Your Brewer

2

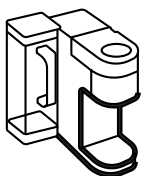

PLUG IT IN

Remove packing tape from brewer and plug into a grounded outlet. The brewer will automatically power on, or press any button to power on.

Make sure you have your home Wi-Fi® password ready.

3



GET CONNECTED

Open the Keurig® app and select **Get Connected**, then create an account.

Once completed, press the right arrow on the brewer to **Connect**.

4



SET UP

Follow the instructions in the app to link the brewer to your smartphone, then to connect to your home Wi-Fi®.

You will see a message that says **SUCCESS!**

Before You Brew

5 Rinse & Fill

Rinse reservoir with fresh water and fill to the Max fill line.

If you have a Keurig® Water Filter, install it now.

NOTE: Do not use distilled water.

6 Clean the Frother

Remove the lid and whisk from inside the frother. Wash the interior of the frother, lid, and whisk with warm, soapy water. Dry all parts thoroughly using a soft, nonabrasive cloth, then reassemble.

NOTE: Frother is not dishwasher safe. Do not submerge frother in water. Only use nonabrasive cleaning materials to prevent damage to the inner surface of the frother. Dry interior of frother and base with a soft cloth after cleaning.

7 Cleansing Brew

Press any button to **power on**.

Place a large mug (10 oz minimum) on the drip tray.

Follow the instructions on the brewer screen to perform a cleansing brew.

Do not remove the water reservoir once the brew button has been pressed until the brew has been completed. The one-time setup process is now complete and you are ready to brew!

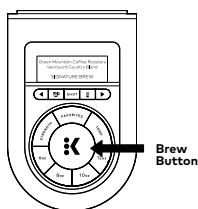
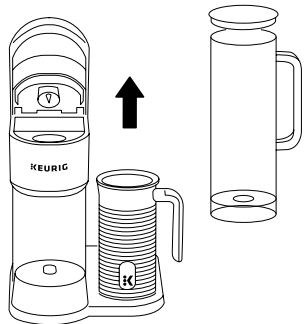

Brew Your First Cup

8 Place Mug & Insert Pod

Lift the handle and place a K-Cup® pod in the K-Cup® pod holder.

Lower the handle completely to close the lid.

Do not remove the foil lid on the K-Cup® pod.

NOTE: Remove the drip tray to accommodate a travel mug up to 7" tall.

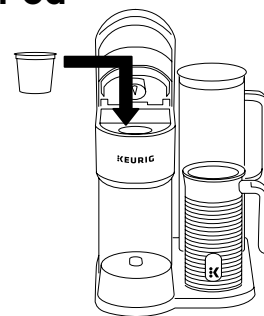

9 Brew & Enjoy!

Enjoy the **Signature Brew** or customize your settings, choose a size, and press the blinking **BREW** button. Once the brew is completed, dispose of the used K-Cup® pod.

Brewing is complete when the "Enjoy" screen is displayed.

CAUTION: While brewing, there is extremely hot water in the K-Cup® pod holder. To avoid injury, do not lift the handle during the brewing process.

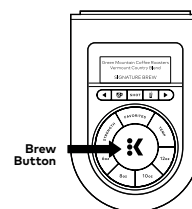

10 Brew a Café Beverage

Go to **Café Creations** in the app for access to a full menu and easy, step-by-step instructions.

1. Froth Milk

Fill frother to the Min line for cappuccino or Max line for latte. Attach lid and place on base.

Toggle the button  to choose a setting.

-  Cold Froth
- 1, 2, 3 Hot Froth

The higher the number, the more froth. Filling to Min will produce more froth than Max. The frother will also retain the settings chosen from the previous usage. Press the K to begin frothing. Frothing is complete when the button is no longer illuminated.

CAUTION: Frother is not microwave or dishwasher safe.

NOTE: Do not under- or overfill frother. Do not operate before adding milk.

2. Queue Your Brewer

Press the **SHOT** button to choose a 2 oz or 4 oz shot, then press the blinking **BREW** button. When frothing is completed, the shot will automatically brew next.







NOTE: The brewer cannot brew coffee and froth milk at the same time.

3. Create Your Café Beverage

When shot is complete, pour or spoon the frothed milk over your shot of coffee.

NOTE: Clean frother immediately after use.

Get To Know Your Brewer

 BrewID™ Recognizes your K-Cup® pod and adjusts the temperature and strength to the Signature Brew.	 CONNECTED CONVENIENCE <ul style="list-style-type: none"> • SMART Auto-Delivery, save 25% on every order • Personalized beverage recommendations • Brew from anywhere or schedule a brew • Manage your favorites • Voice commands with Amazon Alexa or Google Home™
 BARISTA MODE™ Offers easy, step-by-step directions on how to make lattes, cappuccinos, or any creation perfect for you.	
 ULTIMATE CUSTOMIZATION Dial your brew STRENGTH up or down with 5 settings, from Balanced to Intense. Choose the perfect TEMPERATURE with 6 settings, from Warm to Max Hot.	
 MULTISTREAM TECHNOLOGY™ Saturates the coffee grounds more evenly to extract full flavor and aroma.	
 BREW OVER ICE Brew your favorite beverages OVER ICE . Do not use glass. Brews hot coffee extra strong to make up for ice melting and beverage dilution.	
SHOT CAFÉ BEVERAGES The 2 oz and 4 oz shot deliver a concentrated shot for full-flavor, café-style beverages like cappuccinos and lattes.	 SETTINGS <p>Press both arrows at the same time to open the SETTINGS MENU.</p> <ul style="list-style-type: none"> • Wi-Fi®: Connect to your Wi-Fi® network, modify your password, and change the Wi-Fi® settings. • High Altitude: Ensure your brewer works properly at higher altitudes (5,000 feet). • Brewer Information: Provides the latest software version installed on the coffee maker.

Brewer Features

Signature Brew: When using a Keurig® K-Cup® pod recognized by the brewer, the **Signature Brew** light will illuminate to signal the brewer has been set to the strength and temp settings recommended by the expert roaster. If you decide to customize the settings once the K-Cup® pod has been recognized, you will no longer be using the recommended brew settings and the light will no longer be illuminated. If you want to get back to the recommended brew, press the **Signature Brew** button and the settings will revert back to the recommended brew.

Customize Your Brew: Use the **Strength** button to toggle between 5 strength settings: balanced, rich, robust, strong, and intense. When the stronger brew settings are selected, the water flows through the pods more slowly in order to extract more coffee flavor and deliver a stronger taste. Use the **Temperature** button to toggle between 6 temperature settings: warm, warmer, hot, hotter, extra hot, and max hot.

Create a Favorite: To save a customized brew as a favorite, press and hold the **Favorites** button; you can save up to 10 favorites. Favorites can be renamed in the Keurig® app by tapping **Settings**, then selecting a favorite to rename. The Keurig® app can also be used to reorder favorites. In the app, tap **Settings**, then **Favorites**, then ↑ ↓ icon, and then drag the favorites into the preferred order. A favorite can be deleted via the brewer or the Keurig® app. To delete via the brewer, select the favorite you wish to delete, then press and hold the **Favorites** button, and then confirm deletion.

Hot Water Brew: On the home screen with no K-Cup® pod inserted in the brewer, press the K to access hot water. Then choose the size and press the blinking K to brew hot water.

Power On/Auto Off: To power your brewer on, simply press any button or lift the brew handle. Your brewer will automatically turn off after 5 minutes. You can also press and hold the K button to turn the brewer off.

Settings: When the brewer is plugged in and powered on, press both arrows at the same time to open the **Settings** menu. Use the right arrow to scroll through the different features within the menu, including:

- **Wi-Fi®:** Connect to your Wi-Fi® network, modify your password, and change the Wi-Fi® settings.
- **High Altitude:** Ensure your brewer works properly at higher altitudes (5,000 feet).
- **Language:** Choose your preferred language.

- **Water Filter Reminder:** Set the water filter reminder to ensure you always have quality water for your coffee.
- **Brewer Information:** Provides the latest software version installed on the coffee maker.
- **Support:** Provides contact information to get help when you need it.
- **Factory Reset:** Resets to the original manufactured state.

Voice Control (Alexa & Google Home): Open the Keurig® app, tap Settings, tap My Account, tap Voice Control. Follow the prompts in the app.

Alexa and all related logos are trademarks of Amazon.com, Inc. or its affiliates. Google Home and all related logos are trademarks of Google LLC.

Remote Brew: First, place a pod in the brewer and lower the handle. Then place a sufficiently sized mug on the drip tray. This may be done at any point before a remote brew. When you are ready to brew remotely, open the Keurig® app, ensure you are on the Brew tab, select your brew settings, and tap the app's brew button. To override remote brew, you can cancel via the app or power off the brewer.

Remote On & Off: In the Keurig® app on the Brew tab, tap to toggle the power on and off.

Schedule a Brew: Allows you to schedule a brew in advance. From the Brew tab in the app, tap the calendar icon in the top right corner. Then choose the day and time you would like to schedule a brew. Make sure you have enough water in the reservoir, place a pod in the brewer and lower the handle, and place a sufficiently sized mug on the drip tray. You will get a reminder before your next scheduled brew.

Smart Auto-Delivery: Keeps track of how many pods you are using and automatically sends you an order when your remaining inventory is down to 10 days, so you won't run out of pods.

My Brew Style: Tracks your brewing activity within the app and provides recommendations on favorites we think you will enjoy based on what you've been brewing.

Café Creations: Provides curated recipes to make your favorite coffeehouse creations at home. Simple, step-by-step instructions will make you a barista in no time.

ATTENTION!

This brewer is only compatible with the newly designed Keurig® My K-Cup® Universal Reusable Coffee Filter. Do not attempt to use any other reusable filter or previous versions of Keurig® My K-Cup® Universal Reusable Coffee Filter; may cause damage to brewer.



Caring For Your Brewer

Regular cleaning keeps your brewer running smoothly. Always be sure to turn off and unplug your brewer before cleaning.



Brewer Exterior

Keep your Keurig® brewer looking its best by cleaning the exterior from time to time. Just clean the plastic with a damp, soapy, lint-free, nonabrasive cloth. Never immerse the brewer in water or other liquids.

Drip Tray

The drip tray can hold up to 4 ounces of overflow and should be emptied and cleaned occasionally. To remove, slide it toward you, keeping it level to avoid spilling. Rinse and clean with a damp, soapy, lint-free, nonabrasive cloth.



Caring For Your Frother

Clean immediately after each use and before each use. Frother is not dishwasher safe.

To Clean:

1. Remove frother from the base, remove silicone ring from the lid, and remove the whisk.

2. Wash the inner frother, silicone ring, lid, and whisk with warm, soapy water. Use a soft, nonabrasive material to prevent damage.

NOTE: Do not put the frother or frother parts into the dishwasher. Do not immerse the frother in water for cleaning. Do not wash the bottom part of the frother, which contains the electrical plug.

3. Dry all parts thoroughly and reassemble for next use.

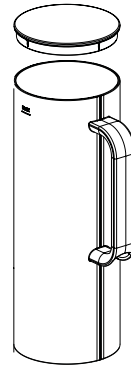

Water Reservoir

The water reservoir should be cleaned periodically by wiping the inside of the reservoir and underside of the lid with a damp, nonabrasive, lint-free cloth. Do not dry the inside of the water reservoir with a cloth, as lint may remain. Allow the reservoir to dry completely.

Regular Maintenance

For great-tasting coffee, keep your brewer running at peak performance by following the recommended maintenance schedule:

Frequency	Product	Benefit
Weekly	Keurig® Rinse Pods	Rinse away residue and oils for a great-tasting cup of coffee every time
Every 3 months	Keurig® Water Filters	Keep your water fresh and clean to enhance the taste of your coffee
Every 3 months or when the Descale notification turns on*	Keurig® Descaling Solution	Eliminate mineral buildup to enhance the taste of your coffee and preserve the long-term health of your coffee maker

*To turn off Descale notification, follow the full descaling procedure as outlined in the Use & Care Guide.

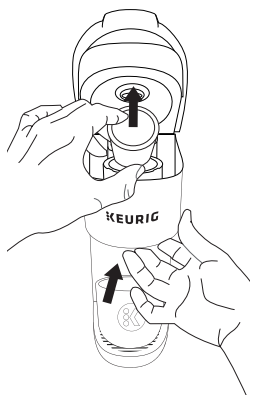

K-Cup® Pod Holder

To remove the K-Cup® pod holder from the brewer, lift the handle and grasp the top of the K-Cup® pod holder with one hand while pushing up on the bottom of the K-Cup® pod holder from underneath with the other until it releases. After cleaning, align the K-Cup® pod holder with the opening using the two front ribs as a guide and snap into place from the top.

CAUTION: There are sharp needles that puncture the K-Cup® pod above the K-Cup® pod holder and in the bottom of the K-Cup® pod holder. To avoid risk of injury, do not put your fingers in the K-Cup® pod holder.

NOTE: Always remove and dispose of the used K-Cup® pod after brewing.

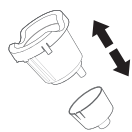

Funnel

Washing the funnel ensures a fresh beverage experience. The funnel should be washed regularly and can be removed from the K-Cup® pod holder by pulling on it until it pops off. To replace it, orient the snaps to the indent and just snap it back onto the K-Cup® pod holder.

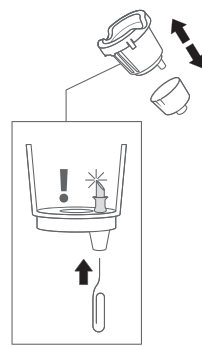

Exit Needle

Remove the pod holder assembly and detach the funnel. Locate the exit needle on the inside bottom of the K-Cup® pod holder. Insert a straightened paper clip into the exit needle to loosen any coffee grounds.

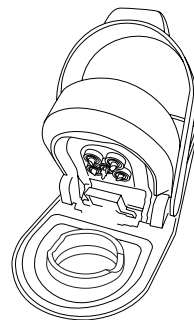

Entrance Needles

Lift the brewer handle and locate the entrance needles on the underside of the lid. To clean the holes in the needles, hold the brewer handle in the upward position and with your other hand, carefully insert a straightened paper clip into all the holes. Gently move it around to loosen any coffee grounds. Lower the handle completely and run a cleansing brew two times. Do not insert a K-Cup® pod.

Descaling Your Brewer

You should descale your brewer every 3 months or when the descale notification turns on. Properly follow the descaling procedure in order to turn off the notification.

Depending on the mineral content of your water, calcium deposits or scale may build up in your brewer. Scale is nontoxic, but if left unattended can hinder brewer performance. Regularly descaling your brewer every 3 months helps maintain the heating element and other internal parts that come in contact with water. Calcium deposits may build up faster, making it necessary to descale more often.

Descaling Procedure

Before you begin, you will need a large ceramic mug, fresh water, Keurig® Descaling Solution, and access to a sink. Do not use a paper cup. Ensure that there is no beverage pod in the K-Cup® pod holder. Please allow approximately 15-20 minutes for the descaling procedure.

STEP 1: Prepare the Brewer

When the Descale notification appears on the screen, press the left arrow, then choose **CONTINUE**. Select your descaling product: **2 oz pouch or 14 oz bottle**. Next, follow the prompts on the screen to complete the descale process. If you would like to descale your brewer but don't see the descale notification on the display, press both arrows at the same time to open **Settings**, then select **Descal Mode**.

Note: Make sure to remove the water filter from the water reservoir if applicable.

STEP 2: Descale the Brewer

Empty the water reservoir and add the Keurig® Descaling Solution to the water reservoir. If using the bottle, fill the empty bottle with water and pour into the water reservoir. If using the pouch, add 3 cups of water (24 oz) to the reservoir. **Do not insert a K-Cup® pod**. Place a large mug on the drip tray.

Press the flashing **BREW** button to dispense 12 oz of hot water. Discard the hot water and replace mug on the drip tray. Repeat until the water reservoir is empty and the screen says **ADD WATER**.

STEP 3: Fresh Water Rinse

Rinse the water reservoir and refill it to the Max fill line with fresh water. Make sure the mug is on the drip tray. When the **BREW** button flashes, press to begin fresh water rinse. Once the brew is complete, pour the hot liquid into the sink. Repeat this step until the screen says **DESCALE COMPLETE**. Now the brewer is ready for use.

NOTE: The cleaning action of Keurig® Descaling Solution may result in a "foam" dispensed from the brewer. This is natural, as the solution is reacting with the scale inside. For a brewer that is heavily scaled, the brewer may not fill properly after the descaler is added. If this occurs, you may see little to no output dispensed, followed by the sound of air blowing out. If this occurs:

- Turn off and unplug the brewer.
- If there is Keurig® Descaling Solution in the water reservoir, discard the contents, rinse the water reservoir thoroughly, and refill with water.
- Plug the brewer back in, power on, and repeat the Step 3 Fresh Water Rinse cycle. The brewer should begin to function normally as the solution is rinsed out and the scale is removed. If problem persists, allow brewer to sit unplugged for at least 30 minutes before continuing with the rinse.

Troubleshooting

Frother:

- If you are brewing coffee, you will not be able to use the frother at the same time. Wait until your brew has completed before pressing the frother button.
- For best froth performance, be sure the whisk is seated properly on the post in the bottom of the frother.
- Some separation of milk and froth can occur, especially if the froth is not poured right away. Pour the milk and scoop the froth into your beverage with a spoon if needed.
- If you are frothing the same milk twice, you may experience a shorter froth time, as the milk will have already reached the target temperature.
- If your milk frother is overflowing, be sure you are filling below the Max fill line inside the frother.
- If your milk frother is scalding or burning the milk, be sure you are filling above the Min fill line inside the frother. Additionally, be sure to clean residual milk at the bottom of the frother after each froth to avoid scalded milk.
- If the milk frother is not turning on, unplug your brewer, wait 30 seconds, plug back in, and try again. If it still does not work, call Customer Service.

Note: Froth time will vary depending on the temperature of the milk.

Grounds in Your Coffee

Grounds may have gathered in the exit or entrance needles and can be cleaned using a straightened paper clip or similar tool.

- Clean the exit needle of the K-Cup® pod holder. Refer to the exit needle care instructions.
- Clean the brewer entrance needles. Refer to the entrance needle care instructions.

For optimal enjoyment and to limit grounds in your cup during hot water brews or when transitioning from brewing a coffee pod to a non-coffee pod (e.g., tea or cocoa), clean the exit and entrance needles per the instructions provided and perform two cleansing brews.

Excessive Grounds in the K-Cup® Pod Assembly Housing

Do not use already punctured pods. That may result in grounds escaping through holes in the lid.

Brewer Will Not Close or Brew With My K-Cup®

Due to the number of entrance needles, older My K-Cup® Reusable Coffee Filters may not be compatible with the brewer. The compatible My K-Cup® filter will have five holes on its lid.

Recommended Brew Settings Are Not Provided or a Keurig® K-Cup® Pod Is Not Recognized

First, make sure your brewer is connected to Wi-Fi® to enable BrewID™. Next, ensure the pod that was used was a genuine Keurig® K-Cup® pod by finding the Keurig® logo on the pod's lid. If a Keurig® pod's lid is already punctured, it may not be recognized. Try again with an unpunctured pod.

If the brewer continues not to recognize Keurig® pods, contact Customer Service.

Brewer Does Not Have Power or Shuts Off

- Plug brewer into its own grounded outlet. If the electric circuit is overloaded with other appliances, your brewer may not function properly. The brewer should be operated on its own circuit, separate from other appliances.
- For energy savings, the brewer automatically turns off 5 minutes after the last brew.
- If the brewer still doesn't have power, contact Customer Service.

Helpful Hints

Water quality varies greatly. If you notice an undesirable taste in your beverage (such as chlorine or mineral tastes), we recommend using bottled or filtered water. Do not use distilled water. You can also install a Keurig® Water Filter to help remove water impurities and improve beverage taste.

Service

Beyond these recommended cleaning and maintenance procedures, this brewer is not user serviceable. For service, please refer to the Warranty section of this guide.

Storage

Empty the water reservoir before storing or transporting and take care to ensure that you store your brewer in a safe and

How Do I Connect My Brewer If I Skipped Connecting It Out of the Box?

Make sure you have your home Wi-Fi® password ready.

First, download the Keurig® app and select Get Connected to create an account.

If you already have the Keurig® app, go to settings in the app, select Connect a Brewer, then Get Started. Scan the QR code on the back of the brewer.

Next, press both arrows at the same time on the brewer to open Settings. Press the right arrow to continue to the Wi-Fi® settings. Press the K button followed by the right arrow to Connect. Tap **LINK** in the app. Follow the in-app instructions.

Brewer Will Not Brew

If you see the Add Water warning, add water to the water reservoir.

- A minimum of 6 oz of water is required to brew. Add an additional 2 oz of water to the reservoir to ensure the minimum fill level has been met, then press the **BREW** button. Repeat until the brewer begins to dispense.

Make sure the water reservoir is seated properly in its base. If the Add Water warning persists even after refilling, contact Customer Service.

Brewing a Partial Cup

- The exit needle may be clogged. Refer to the exit needle care instructions.
- Clean the K-Cup® pod holder; see K-Cup® pod holder care instructions.
- The brewer may need to be descaled. If you have repeated the descale procedure on your brewer two times and it is still only brewing a partial cup, contact Customer Service.

Tips

For the best results, we recommend one-time use with our K-Cup® pods. A twice-brewed pod won't provide full flavor, and if the pod holder isn't lined up with the original holes, it can cause an overflow of water and coffee grounds.

For the best coffee experience, we recommend a cleansing brew after coffee before brewing other type of beverages or a hot water brew.

Milk Matters! Different types of milk produce different results. Depending on which milk you use, here's what you can expect:

- **Fat-Free/Skim Milk:** Easy to froth, it creates a light, airy foam.
- **2% Milk:** Easy to foam like skim milk, but with a creamier consistency.
- **Whole Milk:** Higher fat content creates the richest-tasting foam.
- **Non-Dairy Milk:** Results will vary depending on the type; loses its bubbles more quickly than dairy milk.
- **Lactose-Free Milk:** Less reliable, due to its different properties.
- **Not All Brands Are the Same.** Even individual brands of milk can froth differently, so experiment with different brands to see what works best.

frost-free environment. When you prepare to use it after storage, we recommend rinsing the water reservoir with fresh water and descaling the brewer as detailed in the Descaling Your Brewer section.

If you plan to move your brewer to a different location, turn the brewer off, unplug it, and empty the water reservoir. If your brewer has been in an environment below freezing, please be sure to let it warm to room temperature for at least 2 hours before using.

Click or Call!

Have Questions?

We're here to help. Visit support.keurig.com for step-by-step videos on cleaning, descaling, and more.



Still Need Help?

Give us a call at
1-866-901-BREW (2739)

Warranty

LIMITED ONE-YEAR WARRANTY

Keurig Green Mountain, Inc. (Keurig) warrants that your brewer will be free of defects in materials or workmanship under normal home use for one year from the date of purchase. It is recommended that you register your brewer on keurig.com/new so that your purchase information will be stored in our system. Keurig will, at its option, repair or replace a defective brewer without charge upon its receipt of proof of the date of purchase. If a replacement brewer is necessary to service this warranty, the replacement brewer may be new or reconditioned. If a replacement brewer is sent, a new limited one-year warranty will be applied to the replacement brewer.

This warranty only applies to brewers operated in the United States and Canada. This warranty gives you specific legal rights, and you may also have other rights that vary from state to state and, in the case of Canada, from province to province.

Only the use of Keurig® K-Cup® brand pods and accessories will guarantee the proper functioning and lifetime of your Keurig® brewer. Any damage to or malfunction of your brewer resulting from the use of non-Keurig® pods and accessories may not be covered by this warranty or may result in a service fee if the damage or malfunction is determined to be caused by such use.

WHAT IS NOT COVERED BY THE LIMITED WARRANTY?

THIS WARRANTY DOES NOT COVER CONSEQUENTIAL OR INCIDENTAL DAMAGES SUCH AS PROPERTY DAMAGE AND DOES NOT COVER INCIDENTAL COSTS AND EXPENSES RESULTING FROM ANY BREACH OF THIS WARRANTY, EVEN IF FORESEEABLE. Some states or provinces do not allow the exclusion or limitation of incidental or consequential damages, so the above limitation or exclusion may not apply to you depending on the state or province of purchase.

Nor does this warranty cover damages caused by use of non-Keurig® pods or accessories, services performed by anyone other than Keurig or its authorized service providers, use of parts other than genuine Keurig® parts, or external causes such as abuse, misuse, inappropriate power supply, or acts of God.

OTHER LIMITATIONS

THIS WARRANTY IS EXCLUSIVE AND IS IN LIEU OF ANY OTHER EXPRESS WARRANTY, WHETHER WRITTEN OR ORAL. IN ADDITION, KEURIG HEREBY SPECIFICALLY DISCLAIMS ALL OTHER WARRANTIES WITH RESPECT TO YOUR KEURIG® BREWER, INCLUDING ANY IMPLIED WARRANTY OF MERCHANTABILITY OR FITNESS FOR ANY PARTICULAR PURPOSE. Some states or provinces do not allow disclaimers of such implied warranties or limitations on how long an implied warranty lasts, so the above limitation may not apply to you depending on the state or the province of purchase.

HOW DO YOU OBTAIN WARRANTY SERVICE?

Keurig® brewers are high-quality appliances and, with proper care, are intended to provide years of satisfying performance. However, should the need arise for warranty servicing, simply call Keurig Customer Service at our toll-free phone number, 1-866-901-BREW (2739). Please do not return your brewer for servicing without first speaking to Keurig Customer Service to obtain a Return Materials Authorization (RMA) number. Keurig® brewers returned without an RMA number will be returned to the sender without servicing.

K·Cafe® SMART

SINGLE SERVE COFFEE MAKER

- A. Handle
- B. K-Cup® Pod Holder (B and C are the K-Cup® Pod Holder Assembly)
- C. Funnel
- D. K-Cup® Pod Assembly Housing
- E. Drip Tray Plate
- F. Drip Tray
- G. Drip Tray Base
- H. Water Reservoir Lid
- I. Water Reservoir
- J. Water Reservoir Base
- K. Frother Lid
- L. Frother Whisk
- M. Frother
- N. Frother Base

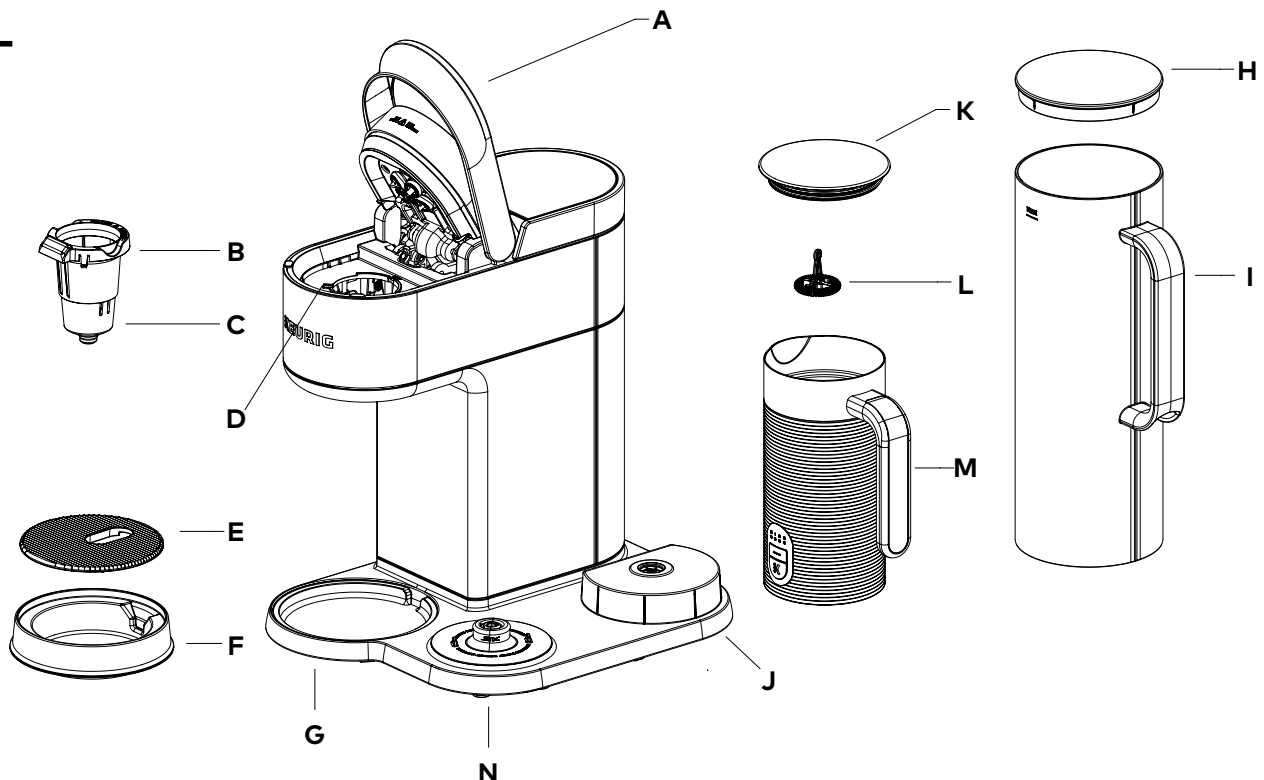

Coffeehouse taste in your own home.

FIND YOUR PERFECT POD

With over 75 brands and hundreds
of varieties, find your match at

keurig.com/new