

Caring For Your Brewer

Regular cleaning keeps your brewer running smoothly. Always be sure to turn off and unplug your brewer before cleaning.

Brewer Exterior

Keep your Keurig® brewer looking its best by cleaning the exterior from time to time. Just clean with a damp, soapy, lint-free, non-abrasive cloth. Never immerse the brewer in water or other liquids.

Drip Tray

The drip tray can hold up to 8 ounces of overflow and should be emptied and cleaned occasionally. To remove, slide it toward you, keeping it level to avoid spilling. Rinse and clean with a damp, soapy, lint-free, non-abrasive cloth.

Water Reservoir & Reservoir Lid

The water reservoir lid and water reservoir should be periodically cleaned with a damp, soapy, non-abrasive cloth and rinsed thoroughly. The water reservoir lid and water reservoir should not be put into the dishwasher. Do not dry the inside of the water reservoir with a cloth as lint may remain. If needed, repeat above procedures.

CAUTION: Please rinse the water reservoir thoroughly after cleaning. This will ensure that no cleaning solutions remain in this area as they may contaminate the water supply in the brewer.

Cleaning Entrance Needles

Lift the brewer handle and locate the top entrance needles on the underside of the lid. To clean both holes in the needles, hold the brewer handle in the upward position and with your other hand, carefully insert a straightened paper clip into the holes. Gently move it around to loosen any coffee grounds. Lower the handle completely and run two water-only brew cycles. Do not insert a K-Cup® pod.

TIP: Refer to support.Keurig.com for video instructions on cleaning the entrance/exit needles.

NOTE: You can also use a Brewer Maintenance Accessory tool to clean the entrance needles. Reach out to Customer Service to get a Brewer Maintenance Accessory.

Pod Holder

Lift the handle. Push up while grabbing the sides of the pod holder assembly. Pull away from brewer. Pull out the pod holder assembly and base. Press the release buttons on both sides of the pod holder assembly. Separate the pod holder from the housing. Clean the pod holder (1), housing (2), and base (3) with a damp, soapy, lint-free, non-abrasive cloth and rinse thoroughly. After all pieces are cleaned, reassemble the pod holder assembly by inserting the pod holder back into the housing. Place the base, then the pod holder assembly into the brew head. Lower the handle.

CAUTION: Sharp needles. Do not put fingers in chamber.

Cleaning the Exit Needle

If a clog arises in the exit needle, push the lever of the pod holder to reveal the exit needle. Use a paper clip or similar tool to loosen the clog. Rinse thoroughly with hot water. After all the pieces are cleaned, place the base then the pod holder assembly into the brew head. Lower the handle.

CAUTION: Sharp needles. Do not put fingers in chamber.

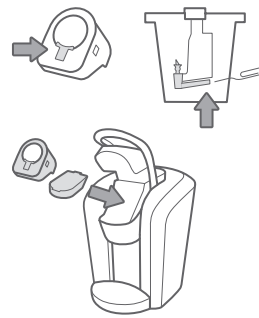
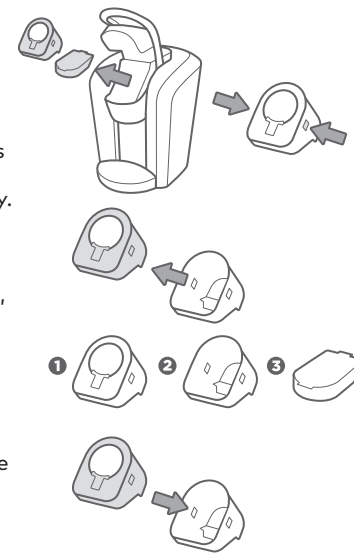

Recycling K-Mug® and K-Carafe® Pods

The plastic cups of K-Mug® and K-Carafe® pods can be recycled wherever #5 plastic is accepted. #5 plastic may not be recyclable in your community today, so please check locally with your municipality or waste hauler, or visit KeurigRecycling.com for more information. #5 plastic is recyclable everywhere in Canada.

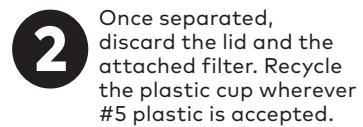
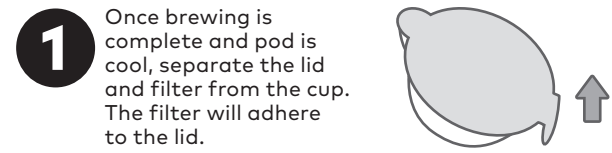

KEURIG®

Keurig Green Mountain, Inc.
33 Coffee Lane
Waterbury, VT 05676

1.866.901.BREW (2739)

Settings Menu

For all settings, press **SAVE** to confirm your selection or use the **BACK BUTTON** to return to the Settings Menu.

Access Settings

Explore everything your Keurig® Plus Series brewer has to offer by accessing the Settings Menu. From the home screen, select the settings button.

Use the arrows to scroll through the menu. To exit, press the back button.

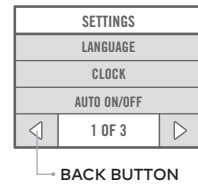

Choose Language

Press English, Spanish, or French to select the language.

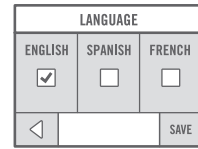

Set Clock

Time: Set the current time using the arrows, then choose AM or PM.

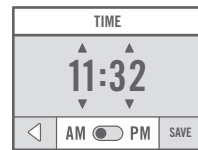

Display: Choose DIGITAL or ANALOG. For digital only, use the toggle to select 12 HR or 24 HR (military).



Auto On/Off

You can leave your brewer on at all times so it is always ready to make your perfect cup, or you can set the auto on, auto off, or energy saver mode.

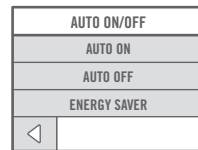

Auto On: Select ENABLE to activate auto on. Use the arrows to set the time for the brewer to automatically turn on.



Auto Off: Select ENABLE to activate auto off. Use the arrows to set the time for the brewer to automatically turn off.



Energy Saver: Set the brewer to turn off in increments of 15 minutes after the last brew.



Temperature

The temperature setting provides even more control over the brewing process.

Use the left and right arrows to choose from low, low/medium, medium, medium/high, and high.

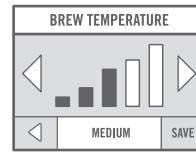

High Altitude

To ensure your brewer works properly at higher altitudes (5,000 feet), ENABLE the high altitude mode.

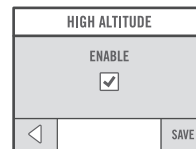

Wallpaper

You can customize your touch-screen color. Simply press a color window to select a wallpaper for the home screen.

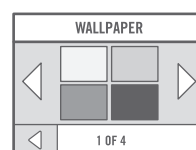

Water Filter Reminder

If you are using a Keurig® Water Filter, select ENABLE to activate the water filter reminder.



Restore Factory Settings

Press YES to restore your brewer to the default settings.

Restoring defaults erases preferred brew settings, temperature, wallpaper, auto on/off, and nightlight settings.

The clock will be set to 12:00 AM.

Press NO to return to the Settings Menu.



Preferred Brew Settings

The preferred brew settings menu allows you to change the default settings for each KEURIG BREW number.

See the Settings and Touch Screen Controls page for a full list of available KEURIG BREW settings.

Use the arrows to set your preferred brew setting. Press SAVE to confirm your selection or use the BACK BUTTON to return to the Settings Menu.

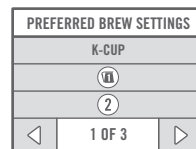

Descaling Your Brewer

You should descale your brewer every 3-6 months. Properly follow the descaling procedure.

Depending on the mineral content of your water, calcium deposits or scale may build up in your brewer. Scale is non-toxic but if left unattended can hinder brewer performance. Regularly descaling your brewer every 3-6 months helps maintain the heating element, and other internal parts that come in contact with water. Calcium deposits may build up faster, making it necessary to descale more often. You should promptly descale when the touch screen indicates "Time to descale the brewer!"



Descaling Procedure

Before you begin, you will need a large ceramic mug, fresh water, Keurig® Descaling Solution, and access to a sink. Do not use a paper cup. Ensure that there is no beverage pod in the K-Cup® pod holder. Please allow approximately 45 minutes for the descaling procedure.

Empty the water from the water reservoir. If there is a Keurig® Water Filter, remove and set aside.

STEP 1: Descaling Solution Rinse

Press and hold the power button to power the brewer off.

Pour the entire bottle of Keurig® Descaling Solution into an emptied water reservoir. Then fill the empty bottle with water and pour into the water reservoir. Press and hold the power button to turn the brewer back on.

Place a large mug on the drip tray and run a cleansing brew by lifting and lowering the handle, selecting the largest brew size and pressing the brew button.

STEP 2: Descaling Rinse & Repeat

Repeat the rinsing brew process until the touch screen indicates "More Water Please". Do not use a K-Cup® pod. Let the brewer stand for at least 30 minutes while still on.

After 30 minutes, discard any residual solution from the water reservoir and rinse thoroughly.

STEP 3: Fresh Water Rinse

Fill the water reservoir with fresh water to and not beyond the MAX line.

Place a large mug on the drip tray plate and run a rinsing brew using the largest brew size.

Do not use a K-Cup® pod. Pour the contents of the mug into the sink.

Repeat brew process until you have completed at least 12 rinsing brews. You may need to refill the water reservoir at least one time during this process.

NOTE: The cleaning action of Keurig® Descaling Solution may result in a "foam" dispensed from the brewer. This is natural, as the solution is reacting with the scale inside. For a brewer that is heavily scaled, the brewer may not fill properly after the descaler is added. If this occurs, you may see only a small or no output dispensed, followed by the sound of air blowing out. If this occurs:

- Turn off and unplug the brewer.
- If there is Keurig® descaling solution in the water reservoir, discard the contents, rinse the water reservoir thoroughly and refill with water.
- Plug the brewer back in, power on, and repeat the Step 3 Fresh Water Rinse cycle. The brewer should begin to function normally as the solution is rinsed out and the scale is removed. If problem persists, allow brewer to sit unplugged for at least 30 minutes before continuing with the rinse.

NOTE: If "Time to descale the brewer!" alert is still indicated on the touch screen, repeat the descaling procedure.

Warranty

LIMITED ONE YEAR WARRANTY

Keurig Green Mountain, Inc. (Keurig) warrants that your brewer will be free of defects in materials or workmanship under normal home use for one year from the date of purchase. It is recommended that you register your brewer on Keurig.com/new so that your purchase information will be stored in our system. Keurig will, at its option, repair or replace a defective brewer without charge upon its receipt of proof of the date of purchase. If a replacement brewer is necessary to service this warranty, the replacement brewer may be new or reconditioned. If a replacement brewer is sent, a new limited one year warranty will be applied to the replacement brewer.

This warranty only applies to brewers operated in the United States and Canada. This warranty gives you specific legal rights, and you may also have other rights that vary from state to state and, in the case of Canada, from province to province.

Only the use of Keurig® K-Cup® brand pods and accessories will guarantee the proper functioning and lifetime of your Keurig® brewer. Any damage to or malfunction of your brewer resulting from the use of non-Keurig® pods and accessories may not be covered by this warranty or may result in a service fee if the damage or malfunction is determined to be caused by such use.

WHAT IS NOT COVERED BY THE LIMITED WARRANTY?

THIS WARRANTY DOES NOT COVER CONSEQUENTIAL OR INCIDENTAL DAMAGES SUCH AS PROPERTY DAMAGE AND DOES NOT COVER INCIDENTAL COSTS AND EXPENSES RESULTING FROM ANY BREACH OF THIS WARRANTY, EVEN IF FORESEEABLE.

Some states or provinces do not allow the exclusion or limitations of incidental or consequential damages, so the above limitation or exclusion may not apply to you depending on the state or province of purchase.

Nor does this warranty cover damages caused by use of non-Keurig® pods or accessories, services performed by anyone other than Keurig or its authorized service providers, use of parts other than genuine Keurig® parts, or external causes such as abuse, misuse, inappropriate power supply, or acts of God.

OTHER LIMITATIONS

THIS WARRANTY IS EXCLUSIVE AND IS IN LIEU OF ANY OTHER EXPRESS WARRANTY, WHETHER WRITTEN OR ORAL. IN ADDITION, KEURIG HEREBY SPECIFICALLY DISCLAIMS ALL OTHER WARRANTIES WITH RESPECT TO YOUR K400 SERIES BREWER, INCLUDING ANY IMPLIED WARRANTY OF MERCHANTABILITY OR FITNESS FOR ANY PARTICULAR PURPOSE.

Some states or provinces do not allow disclaimers of such implied warranties or limitations on how long an implied warranty lasts, so the above limitation may not apply to you depending on the state or the province of purchase.

HOW DO YOU OBTAIN WARRANTY SERVICE?

Keurig® brewers are high-quality appliances and, with proper care, are intended to provide years of satisfying performance. However, should the need arise for warranty servicing, simply call Keurig Customer Service at our toll free phone number 1.866.901.BREW (2739). Please do not return your brewer for servicing without first speaking to Keurig Customer Service to obtain a Return Materials Authorization (RMA) number. Keurig® brewers returned without a RMA number will be returned to the sender without servicing.

Fully experience the benefits that come with your new Keurig® brewer at

KEURIG.COM/NEW



REGISTER

your new Keurig® brewer and receive a special savings offer



DISCOVER

your favorite coffees with our **customized taste quiz** and get personalized recommendations

KEURIG

K400 Series

Use & Care Guide

Get the most from your new Keurig® brewer.

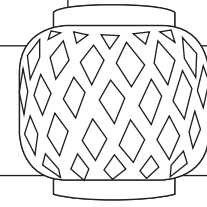
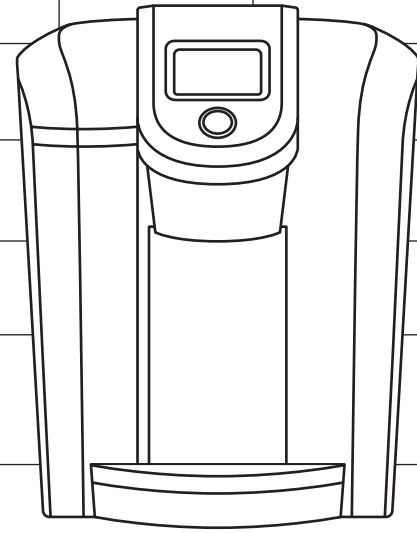

K400 Series Brewer

- A. Flip-Top Reservoir Lid
- B. Water Reservoir
- C. Top Housing
- D. Touch Screen/Power Button
- E. Brew Button
- F. Handle
- G. Brew Head
- H. Power Cord
- I. Drip Tray Plate
- J. Drip Tray
- K. Pod Holder
- L. Housing (K and L are the Pod Holder Assembly)
- M. Base

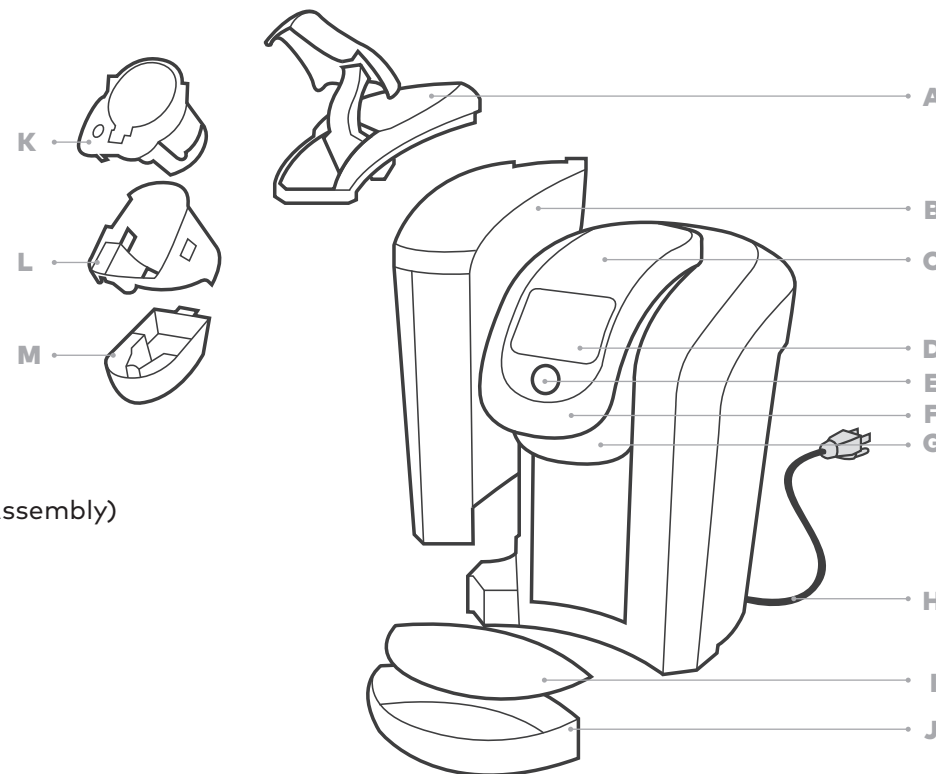

Settings and Touch Screen Controls

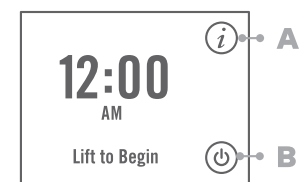

- Home Screen**
- A. Settings Button
 - B. Power Button

Brew Settings

Select the KEURIG BREW setting that matches the number on the pod lid for K-Mug® and K-Carafe® pods.

READY	K-CUP® POD: SIZE OPTIONS	4 oz.	6 oz.	8 oz.*	10 oz.	12 oz.
1	K-CARAFE® POD: SIZE OPTIONS	2-3 cups	3-4 cups*	4-5 cups		
2	K-MUG® POD: SIZE OPTIONS	12 oz.	14 oz.*	16 oz.		
3		12 oz.	14 oz.*			
4		4 oz.	6 oz.	8 oz.*	10 oz.	12 oz.
5			STEP 1 FROTH 4 oz.	STEP 2 FROTH 4 oz.		
6		6 oz.	8 oz.*	10 oz.	12 oz.	

* DEFAULT SIZE

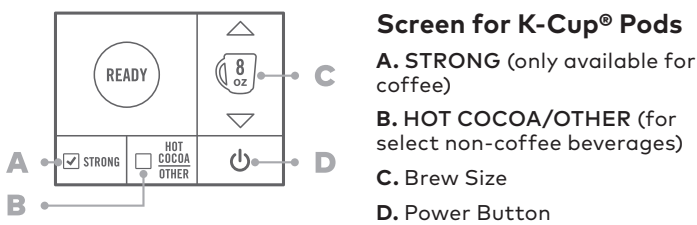

- Screen for K-Cup® Pods**
- A. STRONG (only available for coffee)
 - B. HOT COCOA/OTHER (for select non-coffee beverages)
 - C. Brew Size
 - D. Power Button

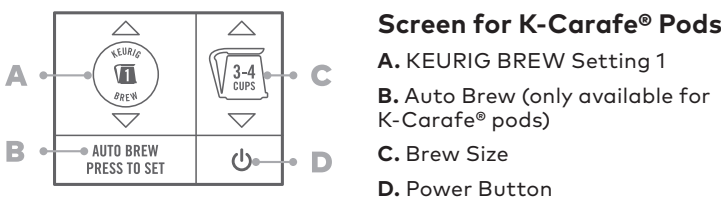

- Screen for K-Carafe® Pods**
- A. KEURIG BREW Setting 1
 - B. Auto Brew (only available for K-Carafe® pods)
 - C. Brew Size
 - D. Power Button

Before You Brew

- 1 Plug & Place**
Remove packing tape from brewer and plug into a grounded outlet. Place a large mug (12 oz. minimum) on the drip tray plate.

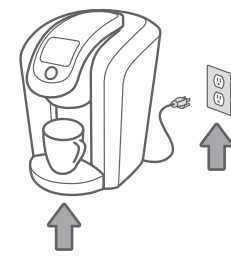

- 2 Rinse & Fill**
Remove the water reservoir lid, then lift the reservoir straight up to remove it. Rinse reservoir with fresh water and fill to the MAX line. Replace water reservoir, making sure the lock tabs engage with the brewer. Replace lid.
NOTE: Do not use distilled water.

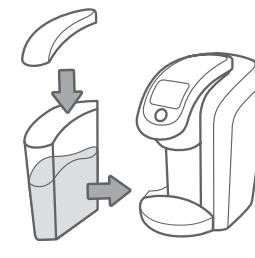

- 3 Power On**
Press the power button. Lift the handle—remove and discard the orange shipping disk. Lower the handle. Wait for preheating to complete, about 3 minutes.

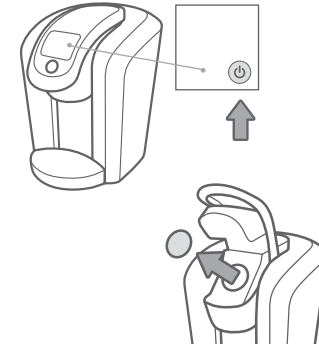

- 4 Cleansing Brew Setup**
Lift and lower the handle. Press the blinking brew button to start a cleansing brew. Pour the hot water into the sink.
The one-time setup process is now complete and you are ready to brew!

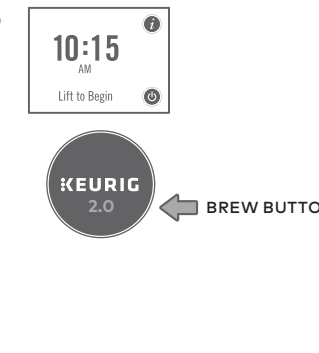

Set Carafe Auto Brew Mode

- 1** Make sure the Keurig® Carafe is empty. Remove the drip tray and insert the Keurig® Carafe securely in its place.



- 3** Select AUTO BREW PRESS TO SET.

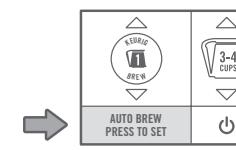

- 5** Select a brew size, then press SET.

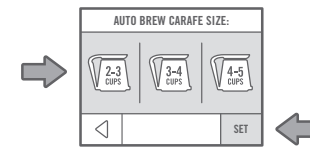

- 7** To edit any options, select TOUCH HERE TO EDIT.

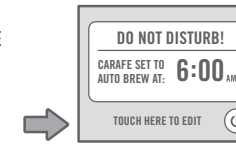

- 2** Select a K-Carafe® pod, place firmly in the pod holder and lower the handle.
NOTE: Ensure the current time is accurate. Refer to Set Clock instructions in the Settings Menu in this guide to adjust.

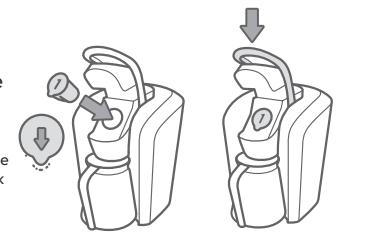

- 4** Select the time you want to begin brewing, then press the right arrow.

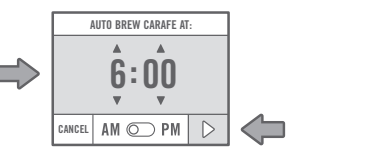

- 6** The touch screen will indicate DO NOT DISTURB!



- 8** To put the brewer in sleep mode, quickly press and release the power button. To cancel the carafe auto brew mode, remove the Keurig® Carafe or lift the handle.



Brew Your First K-Cup® Pod

- 5 Place Mug**
Place a mug on the drip tray plate. If using a travel mug, remove the drip tray and place the mug on the drip tray base.



Hot Water: To dispense hot water into a mug, lift and lower the handle without inserting a K-Cup® pod. Select your cup size then press the blinking brew button to dispense hot water.

NOTE: Between brew cycles, the brewer may take about a minute to reheat.

- 7 Size & Strength**
Select your brew size using the arrows on the screen. Select STRONG if desired. (STRONG setting is for coffee.) Press HOT COCOA/OTHER for select non-coffee beverages.

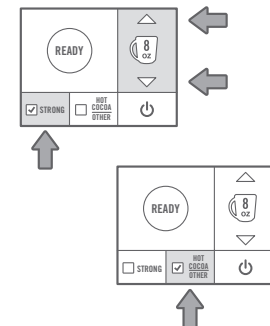

NOTE: Make sure to check instructions on pod packaging.

CAUTION: There is extremely hot water in the K-Cup® pod during the brew process. To avoid injury, do not lift the handle during the brew process.

- 6 Lift & Insert**
Lift the handle and place a K-Cup® pod in the K-Cup® pod holder. Lower the handle completely to close the lid.
Do not remove the foil lid on the K-Cup® pod.

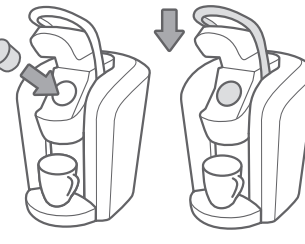

- 8 Brew & Enjoy**
Press the blinking brew button. The button will remain illuminated while brewing, about 1 minute. The brewer will notify you when the brew cycle is complete. Lift the handle and dispose of the used K-Cup® pod. The brewer will be ready to brew another cup in about a minute.



NOTE: To stop the brewing process, press and hold the power button for one second.

Brew Your First K-Carafe® Pod

- 1 Place Carafe**
Make sure the Keurig® Carafe is empty. Remove the drip tray and insert the Keurig® Carafe securely in its place.

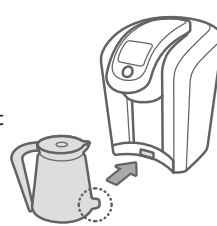

- 2 Lift & Insert**
Lift the handle and place a K-Carafe® pod in the pod holder. Lower the handle completely to close the lid.
Do not remove the foil lid or puncture the K-Carafe® pod.

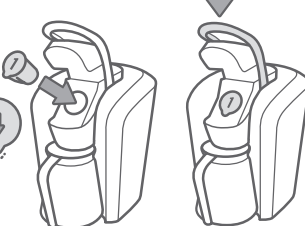

- 3 Select Brew Size**
Select the KEURIG BREW setting that matches the number on the pod lid. Then select the number of desired cups.

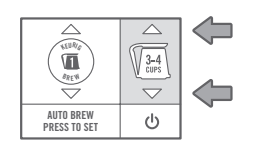

NOTE: Make sure the number on the touch screen matches the number on the K-Carafe® pod in the pod holder.

CAUTION: There is extremely hot water in the K-Carafe® pod during the brew process. To avoid injury, do not lift the handle during the brew process.

- 4 Brew & Enjoy**
Press the blinking brew button. The button will remain illuminated while brewing. The brewer will notify you when the brew cycle is complete. Lift the handle and dispose of used K-Carafe® pod.



NOTE: To stop the brewing process, press and hold the power button for one second.

Troubleshooting

Brewer Does Not Have Power or Shuts Off

- Press and hold the power button and ensure the touch screen is illuminated.
- Plug brewer into its own grounded outlet. If the electric circuit is overloaded with other appliances, your brewer may not function properly. The brewer should be operated on its own circuit, separate from other appliances.
- If the brewer still doesn't have power, contact Customer Service.

Brewer Shuts Off Or Turns On Automatically

- Check to make sure that the AUTO ON/OFF settings have not been set. Refer to the Settings Menu.

Grounds in Your Coffee

Grounds may have gathered in the exit or entrance needles and can be cleaned using a straightened paper clip or similar tool.

- Clean the exit needle of the K-Cup® pod holder. Refer to the Exit Needle care instructions.
- Clean the brewer entrance needles. Refer to the Entrance Needles care instructions.

Brewing a Partial Cup

- The exit needle may be clogged. Refer to the Exit Needle care instructions.
- The water reservoir may have been removed during brewing. Replace the water reservoir and perform a rinsing brew without a K-Cup® pod.
- The brewer may need to be descaled. If you have repeated the descale procedure on your brewer two times and it is still only brewing a partial cup, contact Customer Service.

Brewer Will Not Brew

- After placing a pod in the pod holder, make sure the handle is lowered completely and the touch screen displays the appropriate brew screen. Follow the brewing instructions.
- If the touch screen indicates "More Water Please" add water to the water reservoir or make sure the water reservoir is seated properly in its base.
- If the touch screen indicates "More Water Please" even after refilling, remove the water reservoir and empty the water. Then thoroughly clean the reservoir. Fill the water reservoir to the MAX line, return it to the brewer and ensure it is seated properly in its base.
- The pod holder may need to be cleaned or the brewer may need to be descaled. Refer to Caring For Your Brewer for instructions.

Touch Screen Alerts

- "More Water Please" – If the water level is not low, remove the water reservoir and empty the water. Clean the reservoir. Return the reservoir to the brewer and ensure it is seated properly in its base.
- "Sorry, Brew Interrupted" – Slowly lift the handle, remove the pod, lower the handle and perform a rinsing brew.
- "Sorry, There is a Problem" – Coffee grounds may be stuck in the entrance needle. Refer to Caring For Your Brewer for cleaning instructions.
- "Time To Replace the Keurig® Water Filter" – Your brewer will indicate that it is time to replace the water filter after every 1,000 ounces or two months. Once you've replaced the Keurig® Water Filter press YES to reset the water filter reminder.

Helpful Hints

Water quality varies greatly. If you notice an undesirable taste in your beverage (such as chlorine or mineral tastes), we recommend using bottled or filtered water. Do not use distilled water. You can also install a Keurig® Water Filter to help remove water impurities and improve beverage taste.

Service

Beyond these recommended cleaning and maintenance procedures, this brewer is not user serviceable. For service, please refer to the Warranty section of this guide.

Storage

Empty the water reservoir before storing or transporting and take care to ensure that you store your brewer in a safe and frost free environment. Please be sure to store your brewer in its upright position to avoid water leakage from the inner tank. If you store the brewer in a cold environment, you run the risk of water freezing inside the brewer and causing damage. When you prepare to use it after storage, we recommend rinsing the water reservoir with fresh water and running three rinsing brews without a K-Cup® pod. If you plan to move your brewer to a different location, turn the brewer off, unplug it, and empty the water reservoir. If your brewer has been in an environment below freezing, please be sure to let it warm to room temperature for at least 2 hours before using.

Click or Call!

Have Questions?

We're here to help. Visit support.Keurig.com for step-by-step videos on cleaning, descaling, and more.



Still Need Help?
Give us a call at
1-866-901-BREW (2739)