



LASER TV USER MANUAL

Before using the TV, read this manual thoroughly. We recommend that you keep the manual for future reference.

Copyright Statement

© 2020 Hisense Company Ltd. All Rights Reserved.

All material in this User Manual is the property of Hisense Company Ltd. and its subsidiaries, and is protected under US, CANADA, MEXICO and International copyright and/or other intellectual property laws. Reproduction or transmission of the materials, in whole or in part, in any manner, electronic, print, or otherwise, without the prior written consent of Hisense Company Ltd. is a violation of Hisense Company Ltd. rights under the aforementioned laws.

No part of this publication may be stored, reproduced, transmitted or distributed, in whole or in part, in any manner, electronic or otherwise, whether or not for a charge or other or no consideration, without the prior written permission of Hisense Company Ltd.

Requests for permission to store, reproduce, transmit or distribute materials may be made to one of the following addresses:

USA: Hisense USA Corporation
7310 McGinnis Ferry Road
Suwanee, GA 30024

CANADA: Hisense Canada Co., Ltd
2283 Argentia Road, Unit 16
Mississauga, ON, Canada
L5N 5Z2

MEXICO: Hisense Mexico S. de R.L. de C.V.
Blvd. Miguel de Cervantes Saavedra No 301
Torre Norte Piso 2, Col. Ampliación Granada
Miguel Hidalgo, Ciudad de México, C.P. 11520

Hisense, and any and all other Hisense product names, logo's, slogans or marks are registered trademarks of Hisense Company Ltd. and its subsidiaries. All other trademarks are the property of their respective holders.

©2020. All rights reserved. Hisense and the Hisense logo are registered trademarks of Hisense. Other brand and product names are registered trademarks of their respective owners.

Disclaimer Page

**Notwithstanding anything to the contrary, including in any or all descriptions, representations, statements or other communications related to this Hisense device (hereinafter "Device") made in any form whatsoever and at any time, some or all of the pre-installed, or subsequently installed Application Services may not be available or capable of functioning as intended by the provider of the Application Services in any or all usage areas for reasons outside of Hisense's control, including but not limited to, Internet access, local service limitations, etc. Any purchase or use of the Device, including any Application Services, is purely at the user's risk. Application Services are provided on an as-available basis without warranties of any kind, either expressed or implied, that the Application Service will be uninterrupted or error-free, including but not limited to vagaries of weather, disruption of Service, acts of God, warranties of title, local or regional limitations, no infringement, NOR IMPLIED WARRANTIES OF MERCHANTABILITY OR FITNESS FOR A PARTICULAR PURPOSE. No advice or information given by Hisense, providers, affiliates, or contractors or their respective employees shall create such a warranty. Hisense specifically disclaims responsibility for any or all Application Services from functioning at any time, and by purchasing the Device, you accept such disclaimer without any claim on Hisense. You are solely responsible for providing an active and working connection to the Internet, along with any and all hardware and/or software necessary to use the Hisense Device as intended.

Disclaimer:

Images throughout this document are for illustrative purposes only and may differ from the actual product.

Content

Content	3
Connecting Devices to your TV	5
Connecting an antenna, cable set-top box or satellite receiver	5
Connecting an AV device with an HDMI cable	5
Connecting speakers or other audio receivers	5
Connecting an audio device to use Audio Return Channel (ARC)	6
Connecting a USB device	6
Connecting Your TV to a Wired Network	8
Connecting to a wired (Ethernet) network	8
Using Your TV Remote Control	10
Buttons on your TV remote	10
Remote control range information	11
Completing the Setup Assistant Menu	13
Shortcuts Instructions	14
Turning your TV on or off	14
Using the Live TV	14
Using shortcuts	15
Home	16
Getting familiar with the Home screen	16
Menu	17
Using the Menu	17
Picture	17
Screen	18
Sound	18
Channels	19
Parental Control	19
Audio Only	21
Live TV Closed Captioning	21
Audio Language (MTS)	21
Sleep Timer	21
Settings	21
Help	21
Settings	22
Picture / Screen/ Sound	22

Inputs	22
Parental Control	22
Network & Internet	22
Accounts & Sign In	22
Apps.....	22
Device Preferences.....	23
Remotes & Accessories	23
Device Preferences	24
Amazon Alexa Service	24
Date & time	24
Timer	24
Language	24
Keyboard	24
Storage	24
Home screen.....	24
Usage Mode	25
Google Assistant.....	25
Chromecast built-in.....	25
Screen saver	25
Location	25
Usage & Diagnostics	25
Setup assistant.....	25
Send Diagnostics and Usage	25
Enhanced Viewing	25
Serial Communication Port.....	25
Security & restrictions	25
Accessibility	25
Fast Power On.....	26
Reset	26
Help.....	26
About.....	26
Apps	27
Installing an App	27
Removing an App	27
Moving App Icons around.....	27
Media.....	28
File formats that may be supported	28
Browsing Content.....	28
Quick Problem-Solving Tips	29

Connecting Devices to your TV

You have several options to connect your TV to different devices. The method in which you connect will be based upon the type of cables you have and the available outputs on your device.

Connecting an antenna, cable set-top box or satellite receiver

To connect an antenna, cable set-top box or satellite receiver:

1. Connect one end of a coaxial cable (not included) to the **RF OUT** port on the antenna, cable or satellite box. If you are using an antenna with twin-lead cable, you may need a 300-75 Ohm adapter (not provided) to connect it to the back of your TV. Likewise, if you are using several antennas, you may need a combiner (not provided).
2. Connect the other end of the cable to the **ANT/CABLE** port on the back of TV.
3. Using your remote, select the  **Inputs** icon in Home screen and select **Channels** as the input source.

Connecting an AV device with an HDMI cable

The two high-powered HDMI version 2.0 inputs enable you to connect 4K Ultra-HD external devices that require more bandwidth to transmit to the TV screen. For example, if you have an X-box or Blu-ray player that supports the 2.0 standard.

Please refer to the User Manual that came with your device for step-by-step instructions.

To connect an AV device with an HDMI cable (not provided):

1. Use an HDMI cable to connect the HDMI output port of the AV device to the **HDMI** port of the TV.
2. Plug the connected devices into the **HDMI** port on the TV before switching it on.
3. Using your remote, select the  **Inputs** icon in Home screen and select the corresponding **HDMI** input.

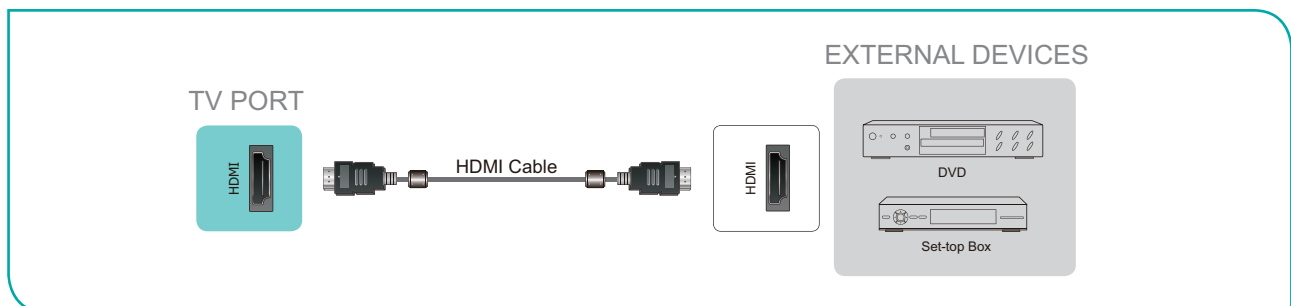

NOTES

- Because the HDMI connector provides video and audio signals, it is not necessary to connect an audio cable.
- We strongly recommend to use HDMI Cable with 2 cores as shown in the figure.

Connecting speakers or other audio receivers

To connect speakers or other audio receivers with an audio cable (not provided):

1. Use an audio cable to connect the digital audio in port of the audio receiver device to the **DIGITAL AUDIO OUT** port of the TV. Another option is to use an audio cable to connect an analog sound system to the **AUDIO OUT** port of the TV.

2. Plug the connected devices into the main power socket before switching on the TV.

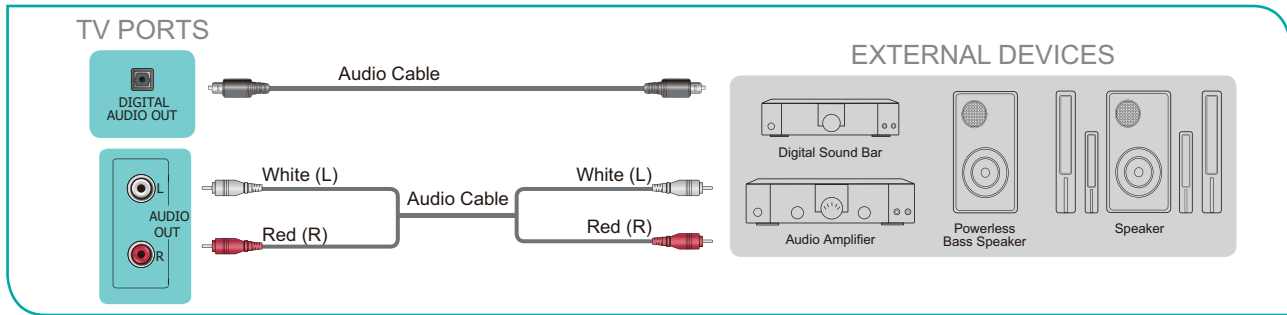

- **TIP:** If you prefer to use Audio Return Channel, then see [Connecting an audio device to use Audio Return Channel \(ARC\) on page 6.](#)

NOTES

- When a digital audio system is connected to the **DIGITAL AUDIO OUT** port, decrease the TV and system volume.
- 5.1 CH (channel) audio is available when the TV is connected to an external device that supports a 5.1 channel surround sound when using Audio Return Channel (ARC) feature.

Connecting an audio device to use Audio Return Channel (ARC)

If you'd like to use the Audio Return Channel (ARC) feature to have sound sent from the TV back down an HDMI cable to an audio device, then you will need to connect the cable to the **HDMI / ARC** port. By using this feature, you will also be able to control the audio device with your TV remote instead of having to use multiple remotes for each device.

To connect an audio device with an HDMI cable (not provided):

1. Connect the audio device to the **HDMI / ARC** port on the TV.
2. Make sure your audio device is powered on.
3. Press the **Home** button on your remote and select the **Settings** icon, then go to **Sound > Speakers**.
4. Select the **ARC** option.

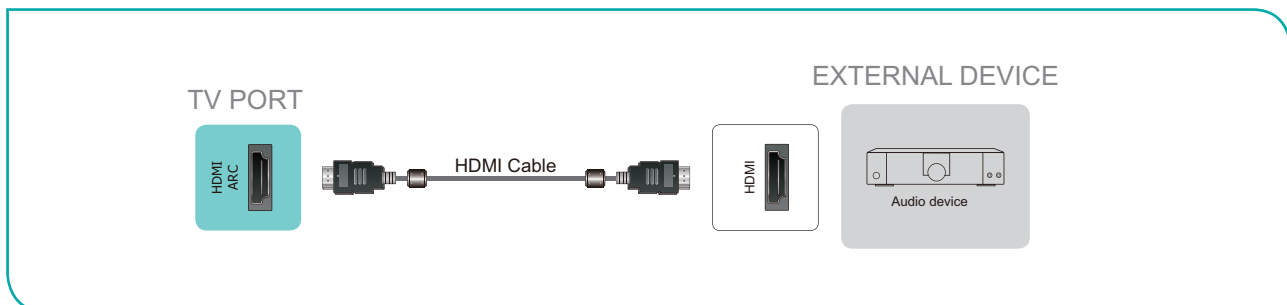

NOTE

- If the audio device has an Input Selector feature then set it to the proper input.

Connecting a USB device

You can connect the USB devices such as hard drives, USB sticks and digital cameras for browsing photos, listening music and watching recorded movies.

1. Connect a USB device into the **USB** port.
2. Select the Media type on the **Media** screen. For more information, see [Media on page 28](#)

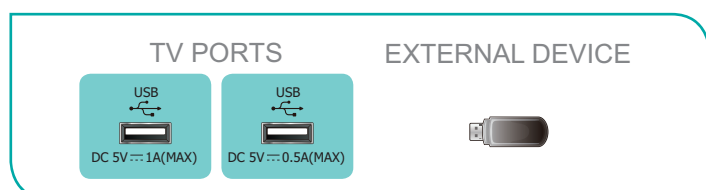

✓ NOTES

- When connecting a hard disk or a USB hub, always connect the mains adapter of the connected device to the power supply. Exceeding a total current consumption may result in damage. The USB2.0 port supports a maximum current of 500mA. The USB3.0 port supports a maximum current consumption of 1A.
- Certain devices may require higher than 1A, and those are not supported.

Connecting Your TV to a Wired Network

You have the option to connect your TV to a wired network to access the Internet. For more information about the network settings on TV, see [Network & Internet on page 22](#)

Connecting to a wired (Ethernet) network

You can attach your TV to your LAN in one of the three following ways:

● Option 1

You can attach your TV to your LAN by connecting the **LAN** port on the back of your TV to an external modem using a Cat 5 LAN cable. See the illustration below.

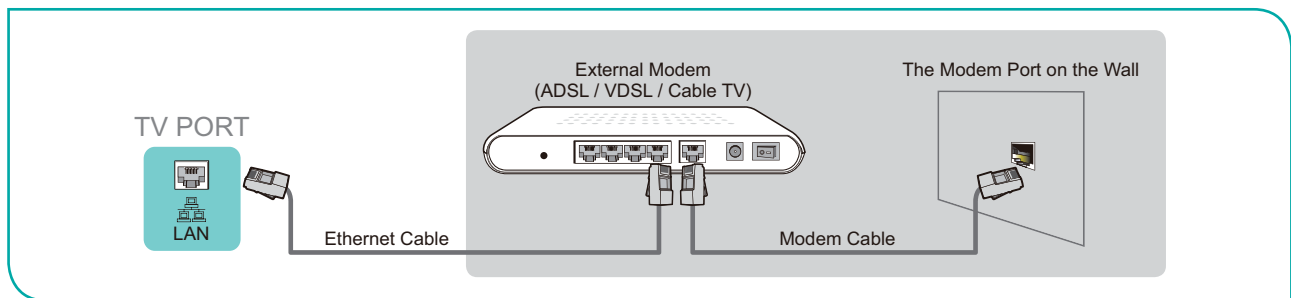

● Option 2

You can attach your TV to your LAN by connecting the **LAN** port on the back of your TV to an IP Sharer which is connected to an external modem. Use an Ethernet cable for the connection. See the illustration below.

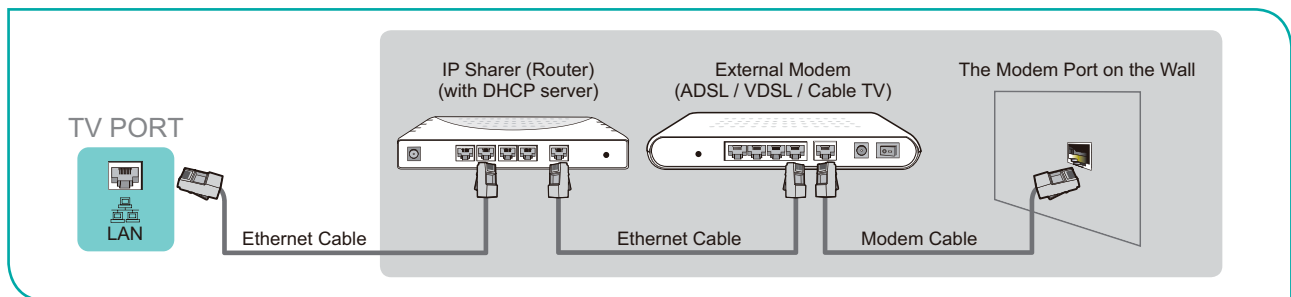

● Option 3

Depending on how your network is configured, you may be able to attach your TV to your LAN by connecting the **LAN** port on the back of your TV directly to a network wall outlet with an Ethernet cable. See the diagram below.

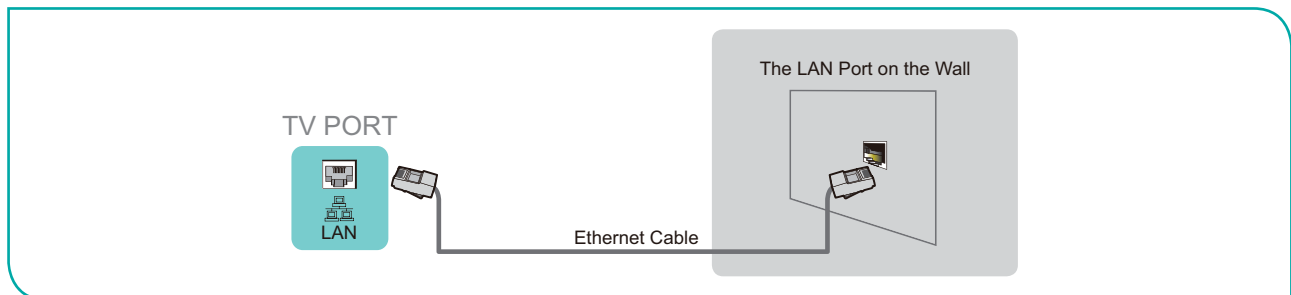

If you have a Dynamic Network, you should use an ADSL modem or router that supports Dynamic Host Configuration Protocol (DHCP). Modems and routers that support DHCP automatically provide the IP address, subnet mask, gateway, and DNS, so you don't have to enter them manually. Most home networks are Dynamic Networks.

Some networks require a Static IP address. If your network requires a Static IP address, you must enter the IP address, subnet mask, gateway, and DNS values manually on your TV's Cable Setup Screen when you set up the network connection. To get the IP address, subnet mask, gateway and DNS values, contact your Internet Service Provider (ISP).

 **NOTE**

- You can use ADSL modems that support DHCP if your network requires a static IP address. ADSL modems that support DHCP also let you use static IP addresses.

Using Your TV Remote Control

Buttons on your TV remote

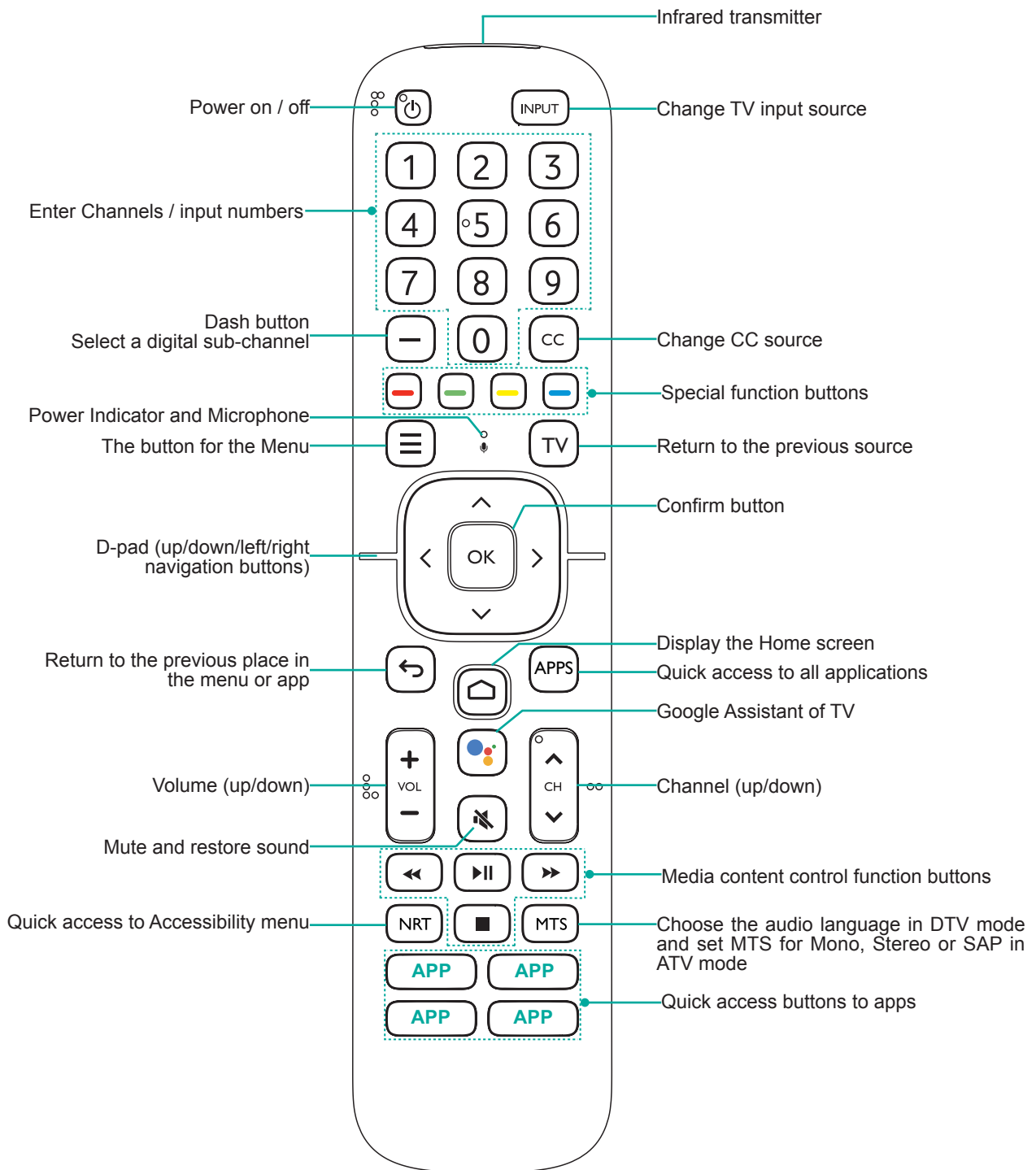

NOTE

- The picture is only for reference. Check information according to the actual remote control in the accessory bag.

Remote control range information

- The remote control can work at a distance of up to 26 feet in front of the TV set.(This distance is used by infrared means in an unpaired state.)
- It can work at a 30 degree horizontal or 15 degree vertical angle.(This angle is used by infrared means in an unpaired state.)

Begin using your remote

1. Take off the back cover to open the battery compartment of the remote control.
2. Insert two AAA size batteries. Make sure to match the (+) and (-) ends of the batteries with the (+) and (-) ends indicated in the battery compartment.
3. Restore the battery compartment cover.

NOTES

- Discard batteries in a designated disposal area. Do not throw them into a fire.
- Remove old batteries immediately to prevent them from leaking into the battery compartment.
- If you do not intend to use the remote control for a long time, remove the batteries.
- Battery chemicals can cause a rash. If the batteries leak, clean the battery compartment with a cloth. If chemicals touch your skin then wash it immediately.
- Do not mix old and new batteries.
- Do not mix alkaline, standard (carbon-zinc) or rechargeable (NiCd, NiMH, etc.) batteries.
- Do not continue using the remote if it gets warm or hot.
- Call our Support Center immediately on the support website.

Program your universal cable or satellite remote control to operate your new television (only for USA)

If you would like to program your other household remote controls to your new television, please refer to the User's Manual supplied by your Cable or Satellite provider. The Cable or Satellite providers' User's Manuals should include instructions on how to program their remote to your television.

A list of codes for the most common Cable and Satellite providers are listed below. Use the code that is associated with your Cable or Satellite provider (if applicable).

DIRECTV

0178, 10178, 10019, 10748, 11314, 11660, 11710, 11780, 12049, 10171, 11204, 11326, 11517, 11564, 11641, 11963, 12002, 12183

Time Warner Cable

386, 0178, 10178, 400, 450, 461, 456, 0748, 1463, 0463, 10463

Comcast

0178, 10178, 10463, 11463, 10748, 11314, 11660, 10171, 11204, 11326, 11517, 11641, 11780, 11785, 11892, 11963, 12002

Cox Communications

0178, 10178, 1326, 1463

Dish Network

505, 627, 538, 720, 659

If the code associated with your Cable or Satellite provider is not listed, does not work or you cannot locate the instructions to program your remote, call your local Cable or Satellite provider's customer service center.

If your Cable or Satellite provider does not have a code available, please contact us.

Using your cable set-top box or satellite receiver remote as a 'universal' remote

If you prefer to use your Cable Set-top Box or Satellite Receiver Remote as a 'Universal Remote', then visit the Support page to view a list of the codes.

Pairing the Remote Control

1. Pair the remote to the TV after you power it on. Keep the remote control within 10 feet from the TV. Press and hold the [] button at least 3 seconds to start pairing.
2. If the remote paired successfully then a confirmation will display on the screen. If it did not pair successfully then an unsuccessful message will display. Repeat step 1.

NOTE

- If an unknown error occurred with the remote then it could have been caused by interference. Try to remove what's causing the interference and pair it again.
- If an unknown error occurred in the remote control while the battery power is normal, you can take out the batteries and press any key for 1~2 seconds, then the remote control can work normally.
- The remote cannot be paired to the TV while the TV is in standby mode.

Completing the Setup Assistant Menu

Plug the power cord into an AC outlet, the TV will turn on.

After the splash screen that displays the logo appears, begin the Setup Wizard menu.

The guide setting is completed according to the boot navigation prompt. The navigation information is specific to the actual condition.

The Home screen will be your starting point for navigating the TV.

Shortcuts Instructions

You can use shortcuts on the remote control for fast operation.

Turning your TV on or off

- To turn your TV on:
 1. Connect the power cord to the back of the TV, then plug the power cord into an AC outlet.
 2. When the TV is powered on, press the **[⏻]** button on the remote to turn on TV.
- To turn your TV off, press the **[⏻]** button on the remote.

NOTES

- When your TV is in standby mode, it is still consuming power. To completely disconnect power, please remove the plug from the AC outlet.
- If your TV does not receive an input signal for several minutes, it automatically goes into standby mode.

Using the Live TV

To view broadcast programs, press the **Home** button to access the Home screen on your remote, select the **Inputs** icon in Home screen and select **Channels** as the input source.

Channel search guide

When you select **Channels** as input, if no TV channels were saved before, you will be prompted to do a channel search. You can also go to **Menu > Channels** to change the channel settings.

Launch Live TV

After channel scanning is done for the first time, the screen will display LiveTV operating tutorial, including: how to Load info Bar, how to load the channel list and so on.

- [Up]** Load info bar
- [OK]** Load channel list
- [≡]** Load onscreen menu
- [↶]** Jump to previous channel

Viewing channel information

As you use the **[CH ^ / ∨]** button on your remote to scroll through channels, an information banner appears on the top of the screen.

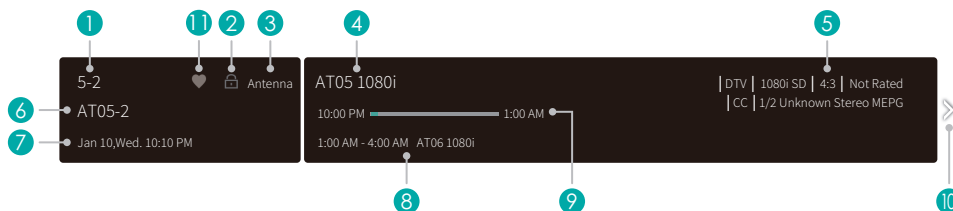

The information banner displays the following information:

1. Channel number
2. Lock status
3. Input
4. Program name
5. Show identification
6. Channel name
7. Current date and time

8. Beginning and end time of the next program
9. Start/Stop time progress bar of the current program
10. Prompt
11. Favorite channel

If you are watching a particular channel, you can also press the **[Up]** button of your remote to view channel information.

Viewing a channel list

After you have done an automatic channel scan (if you're using an antenna) or receiving your channels through a cable provider, you can view your list of channels by pressing **[OK]** on your remote.

You will see the channel list display on the right side of the screen.

Creating a Favorite List

To quickly access your most-watched channels, you can create a Favorite List in one of two ways.

- The first way is to create your Favorite List in Menu:
 1. Press the **[≡]** button to access the **Menu** in Channels source.
 2. Select **Channels > Favorite List**.
 3. Using the **[Up / Down]** buttons of your remote, select a channel and press **[OK]** button.
- The second way is to create your Favorite List in channel list:
 1. Press the **[OK]** button to call out the channel list in Channels source.
 2. Select a channel and add it by using the green button.

A heart-shaped indicator will appear beside the channel as confirmation that it has been successfully added.

Viewing your Favorite list

To view channels that you've added to your Favorite List simply press **[OK]** on your remote to call out the channel list.

The channel list appears on the right side of the screen and heart-shaped icons are shown next to the channels that make up your Favorite List. You can press the **[Left / Right]** buttons to switch the channel list (**ANTENNA** or **CABLE**), **FAVORITE** and **HISTORY** list.

Using shortcuts

Google Assistant

You can press the **[🗨️]** button to turn on your Google Assistant, use your voice to ask it questions, tell it to do things.

Closed Caption (CC)

You can switch among Off, On and On when mute.

Narration (NRT)

You can switch between Video Description On and Video Description Off.

Audio Language (MTS)

You can choose the audio language in DTV mode and you can set MTS for Mono, Stereo or SAP in ATV mode.

Home

Getting familiar with the Home screen

The simple design of the **Home** screen menu makes it easy to navigate. And you can easily add or delete applications in the Home interface according to your needs.

To access the Home screen, press the **Home** button on your remote control and use the D-pad to make your selection.

Indicators and Icons on the top of the Home screen

- **Google Search:** You can search movies, TV, and more by speaking or typing.
- **Notifications:** Notifications can come from the system, an external device, an application, the media player etc.
- **Inputs:** Select the Input source depending on the device you have connected to your TV.
- **Network & Internet:** You can set up the Network & Internet.
- **Settings:** Settings lets you configure the TV, set app options, add accounts, and change other preferences.
- **Time:** You can always view the current time at the top right corner of the Home screen.

Names of sections that appear on the Home screen

The Home screen displays the following section names:

- **Apps**
- **Feature Apps**
- **Recommended content**

Menu

Your TV comes with many TV setting features to allow you to customize the picture based on your viewing preference and environment. As you navigate throughout different screens to access settings, some of the indicators appear as words On and Off.

Using the Menu

You can press the [] button to access the **Menu** in TV mode.

The **Menu** consists of the following settings:

- **Picture**
- **Screen**
- **Sound**
- **Channels**
- **Parental Control**
- **Audio Only**
- **Live TV Closed Captioning**
- **Audio Language(MTS)**
- **Sleep Timer**
- **Settings**
- **Help**

In each menu, you can:

- Press the [**Up / Down**] buttons to select an item.
- Press the [**OK**] buttons to enter the sub-menu or to set on or off.
- Press the [**Left / Right**] buttons to adjust the value.
- Press the [] button to return to the previous menu.

Picture

- **Light Level:** Adjust how bright you want images to appear, lower settings create darker images.
- **Picture Mode:** If you'd like to configure the settings for your picture, then there are some types of picture modes available.

Once you choose the mode, you can adjust the picture based on the following settings:

- **Contrast:** Adjust the Contrast level to increase or decrease how bright images appear.
- **Brightness:** Adjust the Brightness level to generate lighter or darker images.
- **Color:** Adjust the color intensity of the picture for a more vibrant image.
- **Tint:** Adjust the colors from a green to magenta tint to view the natural skin tones of people on the screen.
- **Sharpness:** Adjust how sharp or soft edges of images appear.
- **Picture Size:** Adjust the Aspect Ratio to stretch or zoom in on your picture. You can choose from the following settings: **Auto**, **Normal**, **Zoom**, **Wide**, **Direct**, **Dot-By-Dot**, **Panoramic** or **Cinema**.
- **HDMI 2.0 Format:** Match the connected device output format. You can select **Standard format** and **Enhanced format** in HDMI mode. Enhanced format for devices of 4K@50/60Hz (YCbCr4:4:4, YCbCr4:2:2).
- **Advanced Settings:** Adjust advanced picture settings based on your viewing preference.
 - **Overscan:** Change the video size settings to slightly crop the edges of the displayed image.
 - **Color Temperature:** Select a preset color temperature. Adjust how warm(red) or cool(blue) the white areas of an image appears.
 - **Motion Enhancement:** This setting minimizes afterimages that are left on the screen when viewing fast-moving objects. You can adjust it from **Off**, **Custom**, **Film**, **Clear**, **Standard** or **Smooth**. A Smooth setting will produce a

smoother picture whereas a Clear setting will result in a picture that has less judder (shaking).

NOTE

- Some models don't support this function.
- **Noise Reduction:** Improve how clear the picture appears by reducing noise.
- **Digital Noise Reduction:** Improve picture clarity by reducing video noise.
- **HDMI Dynamic Range:** Adjust the HDMI signal range to be more suitable for the content. (HDMI mode only)
- **Active Contrast:** Automatically darken dark areas and lighten light areas of images to see more details.
- **Color Space:** Change the range of colors the TV displays.

NOTE

- Some models don't support this function.
- **Calibration settings:** Adjust the color space and Gamma to best suit the content you're viewing.
- **Color Tuner:** Adjust the Hue, Saturation and Brightness of color settings.
- **White Balance:** Adjust the intensity of red, green and blue lights to view the true colors of all images in the picture.
- **Gamma Calibration:** Adjust selected Gamma curve.
- **RGB only:** View images based on default settings or choose the color red, blue or green.
- **Apply Picture Settings:** Adjust current picture mode to apply to all sources or just current source.
- **Reset:** Reset current picture settings to factory mode.

Screen

- **Projection mode:** Flip the image over top-to-bottom and/or left-to-right based on the positioning of your TV.
- **Auto geometric correction:** Follow the on-screen prompts to complete the geometric correction step by step.
- **Geometric correction:** Adjust the position of the point by pressing the UP/DOWN/LEFT/RIGHT buttons.
- **Eye protection:** In order to protect your eyes, do not look into the lens. This projector is shutting down in 5 seconds, The TV screen is closed immediately.

Sound

- **System sounds:** Open the default system sound.
- **dbx-tv[®] Sound Mode:** Select a preset sound mode to suit the type of content you are listening to: **Standard**, **Theater**, **Sports**, **Concert Hall**, **Music**, **Speech**, **Late Night** and **User Mode**.

Once you choose the mode, you can adjust the audio based on the following settings:

- **Speakers:** Select the speakers which you want to use: **TV Speaker**, **ARC** or **Bluetooth**.
- **Total Sonics™** : Optimizes overall sound quality by increasing bass, making dialog clear and natural, and widening the sound field.
- **Total Surround™** : Provides surround sound experience with psycho-acoustic processing to place sounds beside, behind, and above the viewer. For best results use with Total Sonics.
- **Total Volume™** : Maintains consistent loudness levels from wide dynamic range programs, loud commercials, and channel or input changes.
- **Advanced Settings:** Tune the audio settings and quality of the TV.
 - **Balance:** Adjust the left and right speaker strength to optimize audio for a specific location.
 - **Digital Audio Out:** Select the digital audio out format that best suits the audio device type. For example, choose **DDP** (Dolby Digital Plus) if you have an AV device which supports Dolby Digital Plus 5.1. Choose **PCM** if you have an amplifier that does not support Dolby Digital technology.

NOTE

- When connected the TV with optical, DDP is not suggested.
- If your audio device supports dolby digital, then select DD; if not, select PCM.
- **Digital Audio Delay:** Adjust the digital audio out delay time to sync sound from an external speaker with the images on the TV.

- **Lip Sync:** Synchronize the displayed image with the audio output.
- **Equalizer:** Boost the volume at different frequencies.
- **Preferred Audio Language:** Set the default audio output language for the type of digital broadcast content that you're viewing.
- **Reset:** Reset current audio settings to factory mode.

Channels

- **Tuner Mode:** Select if you receive TV channels over the air (antenna) or through a cable set top box.
- **Auto Channel Scan:** Automatically scan for channels.
- **Manual Scan:** Type in a channel to add it manually to your TV.
- **Channels Skip:** Skip selected channels from your Channel List.
- **Favorite List:** Add Channels to your Favorite List.

Parental Control

The Parental Control setting allows you to block content that is not appropriate for children to watch.

Turning Parental Control On

1. Press the **[OK]** button on your remote to turn **Parental Control** on.
2. Create PIN window displays. Using the D-pad on your remote, create the password.

You will see the other Parental Control settings change from a greyed out state to highlighted. When this occurs, begin adding other settings to the **Scheduled Blocking, Channel Blocking, Program Blocking, Input Blocking, Change PIN** or **Rest** features.

- **Scheduled Blocking:** Block all selected channels and programs during selected periods of time.
- **Channel Blocking:** Block selected channels.
- **Program Blocking:** Block programs by ratings. For more information about Ratings, See [Description of U.S. TV Ratings on page 19](#).
 - **Open V-Chip:** Turn this On to automatically block programs based on the US rating.
 - **Block Unrated:** Block or unblock unrated movies.
- **Input Blocking:** Block selected inputs.
- **Change PIN:** Change the PIN that you use to access Parental Control.

NOTE

- If you forget your password, call the **Consumer Electronics Care Center**.
- **Reset:** Reset Parental Control back to the factory setting.

Description of U.S. TV Ratings

Content	Defined as
A	All
D	Suggestive dialog
L	Coarse or crude language
S	Sexual references
V	Violence
FV	Fantasy violence

Description of Age-based Ratings

Age	Defined as
TV-Y	All children
TV-Y7	Directed to older children
TV-G	General audience
TV-PG	Parental Guidance Suggested
TV-14	Parents strongly cautioned
TV-MA	Mature Audiences Only

U.S. Movie Ratings

Rating	Defined as
G	General audience
PG	Parental Guidance suggested
PG-13	Parents strongly cautioned
R	Restricted
NC-17	No one 17 and under permitted
X	A rating that has now been superseded by NC-17

Canadian English Ratings

Rating	Defined as
C	Children
C8+	Children 8 years and older
G	General programming that is suitable for all audiences
PG	Parental Guidance
14+	Viewers 14 years and older
18+	Adult Programming

Canadian French Ratings

Rating	Defined as
G	General (appropriate for all ages and must contain little to no violence or sexual content)
8ans+	General but inadvisable for young children(could contain scenes disturbing to children under eight). Recommended for viewing with parent.
13ans+	Programming is appropriate for children 13 and older and may contain moderate violence, language and some sexual situations.
16ans+	Recommended for children 16 and older and may contain strong violence, language and sexual content.
18ans+	Programming intended for viewers that are 18 and older. Programming may contain extreme violence and graphic sexual content/pornography.

NOTE

- All ratings that are higher than those you select are also blocked. For example, if you choose to block the PG-13 rating, then the higher ratings (R and NC-17) are automatically blocked too.

Audio Only

When you select this option, the screen will not display the picture. You can only listen the audio. Press any button except the [⏻] button, [VOL +/-] buttons and [🔇] button to restore operation.

Live TV Closed Captioning

- **Closed Caption:** You can switch between **Off**, **On** and **On when mute** in Channel mode.
- **Analog Closed Caption:** Select an Analog Closed Caption setting from **Off**, **CC1-CC4**, **TEXT1-TEXT4**.
 - **CC1-CC4:** Closed Caption appears in a small banner across the bottom of the screen. CC1 is usually the “printed” version of the audio. CC2-CC4 display content provided by the broadcaster.
 - **TEXT1-TEXT4:** Closed Caption that covers half or all of the screen. TEXT1-TEXT4 display content provided by the broadcaster.
 - **Off:** To turn off the Analog Closed Caption.
- **Digital Closed Caption:** Select a Digital Closed Caption: **Off**, **Service1-Service6**.
- **Digital Caption Style:** There are two caption styles. One is the **Auto**, while the other is the **Custom** style where you can adjust the Font Size, Font Style, Font Color, Font Opacity, Background Color etc.

Audio Language (MTS)

You can choose the audio language in DTV mode and you can set MTS for **Mono**, **Stereo** or **SAP** in ATV mode.

Sleep Timer

Set the sleep timer to automatically turn the TV off within a specified time: off, 10 Minutes, 20 Minutes, 30 Minutes, 40 Minutes, 50 Minutes, 60 Minutes, 90 Minutes and 120 Minutes.

Settings

Settings lets you configure the TV, set app options, add accounts, and change other preferences. For more information about Settings, See [Settings on page 22](#)

Help

- **System message:** View system message, including: Serial Number, Service Code, Software Version etc.
- **Signal information:** Perform self diagnosis to test sound, picture and connections.

Settings

Picture / Screen/ Sound

See other chapters for more information about these settings. For example, for Picture settings, see [Picture on page 17](#).

Inputs

You can see the state of devices that the TV connected: Connected Input, Standby Input and Not connected Input.

Consumer Electronic Control (CEC)

- **HDMI control:** Allow the TV to control HDMI devices.
- **Device auto power off:** Power off HDMI devices with the TV.
- **TV auto power on:** Power on the TV with HDMI device.

NOTES

- HDMI cables must be used to connect HDMI CEC-compatible devices to your TV.
- The HDMI CEC feature of the connected device must be turned on.
- If you connect an HDMI device that is not HDMI CEC-compatible, all the HDMI-CEC Control features do not work.
- Depending on the connected HDMI device, the HDMI-CEC Control feature may not work.

Parental Control

See [Parental Control on page 19](#)

Network & Internet

- **Wi-Fi:** Turn on the Wi-Fi to access the Internet via a wireless network connection.
Select an available network, press **[OK]** to confirm. A screen will appear prompting you to enter the password if necessary.
- **See all / See fewer:** Press **[OK]** to view all available network or fewer.
- **Add new network:** You can add wireless network.
- **Scanning always available:** Check to scan for networks even when Wi-Fi is turned off.
- **Wake on Wireless Network:** Wake on wireless network.
- **Wake on LAN:** Wake on LAN.
- **Wake on Cast:** Wake on Cast.
- **Connected / Not connected:** Show whether the Ethernet is connected
- **Proxy settings:** You can set the proxy server.

NOTE

- HTTP proxy is used by the browser but may not used by other apps.
- **IP settings:** Configure the IP setting for your network connection.
- **Content Sharing:** Allow to view videos, images and music shared from another device in your network.

Accounts & Sign In

You can use multiple Google Accounts on your TV. You may also be able to add other kinds of accounts, depending on your apps.

Apps

You can view details about an app or other item listed. The information and controls available vary among different types of apps.

Device Preferences

See [*Device Preferences on page 24*](#)

Remotes & Accessories

Search for accessories, Before pairing your Bluetooth devices, make sure they're in pairing mode.

Device Preferences

Amazon Alexa Service

Use your voice to control the TV, other smart home devices, and more.

- **Amazon Alexa Service:** Turn on and off Alexa service.
- **Amazon Alexa Service Setup:** Set up accounts to use Alexa service.
- **Setup Checklist:** Check the current settings of Alexa and guide the user to set up.
- **Things to try:** Show the main functions that the Alexa can support currently.

Date & time

- **Automatic date & time:** Use network-provided time. You can also set the current time manually when **Off** is selected.
- **Set date:** Set the date.
- **Set time:** Set the time.
- **Set time zone:** Select your time zone.
- **Use 24-hour format:** Set the time to display in a 12 or 24-hour format.

Timer

- **Sleep Timer:** Set the sleep timer to automatically turn the TV off within a specified time: off, 10 Minutes, 20 Minutes, 30 Minutes, 40 Minutes, 50 Minutes, 60 Minutes, 90 Minutes and 120 Minutes.
- **Power On Timer Type:** Set the type Off, Daily, Once.
- **Power On Timer :** Set the clock for the time you want the TV to turn on automatically.
- **Power Off Timer Type:** Set the type Off, Daily, Once.
- **Power Off Timer :** Set the clock for the time you want the TV to turn off automatically.

Language

Adjust the default Language settings for the TV.

Keyboard

Adjust the default settings for the keyboard.

Storage

You can view the TV storage.

Home screen

- **Customize channels:** Add or delete the app icon from Home screen.
- **Enable video previews:** Enables or disables the video previews.
- **Enable audio previews:** Enables or disables the audio previews.
- **Reorder apps / Reorder games:** Rearrange the Apps screen.
- **Android TV Home / Android TV Core Services:** See the information of open source software licences.

Usage Mode

Set the TV to use in Home or Store mode. Some models have a Store(with 4k demo) mode.

Google Assistant

You can view permissions about accounts and limit the search results.

Chromecast built-in

Enables you to extend your app to direct its streaming video and audio to the TV.

Screen saver

Enables Screen saver when the TV is idle.

Location

Your TV can use different modes to access location information. Each mode uses different sources to estimate the TV's location.

Usage & Diagnostics

Help improve Android performance by automatically sending diagnostics information.

Setup assistant

Use the Setup assistant for instructions to help you set up your TV.

Send Diagnostics and Usage

Allow to send the diagnostics and usage of the report.

Enhanced Viewing

You can set Automatic Content Recognition, Picture Mode Auto Adaption, Sound Mode Auto Adaption, etc.

Serial Communication Port

The Serial communication port protocol is used for communication between a PC or video system controller and TV(s).

Security & restrictions

Enables unknown sources, checking of apps installed for harmful behavior.

Accessibility

- **Captions:** Displays and sets the closed captions.
- **Live TV Closed Captioning:** Displays and sets the TV closed captions.
- **High contrast text:** Improves contrast for visually impaired.
- **Video Description:** Enables broadcasted descriptive audio for visually impaired.
- **TalkBack:** Controls spoken feedback for visually impaired users.
- **Switch Access:** Collects all of the text you type, except passwords. This includes personal data such as credit card numbers.
- **Text to speech:** Lets you specify text-to-speech engine details and speech rate.

Fast Power On

Turn on Fast Power On, this mode can improve boot speed, but affect standby power consumption, Turn off Fast Power On, the boot mode will return to DC mode.

Reset

You can reset to the factory data.

Help

See system message and signal information.

About

See other chapters for more information about these settings.

Apps

Numerous factory-installed apps are available for you to choose from for your entertainment preferences.

Installing an App

To install an app:

1. From the Home screen, click on the **Apps** and select the **Get more apps**.
2. Use the navigation buttons on your remote to select the app that you want to install.
3. Select the **INSTALL**.

Removing an App

You can only delete apps that you've installed to the TV. Factory-installed apps can not be deleted.

To delete an app:

1. From the Apps screen, use the navigation buttons on your remote to select the app that you want to remove. Long press the **[OK]** button on your remote.
2. Click on **Uninstall**.
3. A dialog message displays that asks do you want to uninstall this app. Confirm and the icon is removed from the Apps screen.

NOTE

- If an app is deleted, the information related to that app is also removed.

Moving App Icons around

To move an app:

1. From the Apps screen, use the navigation buttons on your remote to select the app that you want to move. Long press the **[OK]** button on your remote.
2. Click on **Move**.
3. Use the navigation buttons on your remote to move the location of app. Press the **[OK]** button to confirm.

Media

Media is a central location for you to view or listen to different types of content (for example, your photos, music and movies) through the following methods:

- A USB thumb drive or hard drive
- Compatible mobile phone, tablet or other personal devices: You can stream movies, music and photos that are stored on Compatible personal device and play or view the content on your TV.

File formats that may be supported

NOTE

- Due to differences in programming tools and other factors, some of the file formats that are listed may or may not be supported.

Medium	File Format
Video	.avi (XviD, Mpeg2, H.264), .mkv (H.264, H.265), .mpg (Mpeg2), .ts (H.264, H.265)
Picture	.jpg
Music	.mp3

Browsing Content

To browse through content based on the type that you wish to access:

1. Navigate to the appropriate menu tab on the screen and select **All Media**, **Videos**, **Photos** and **Music**.
2. Click on the name of the folder that contains your content.
3. Make your selection to play or view the content.

If you want to close out of the Media center, then press the [BACK] button on your remote.

Quick Problem-Solving Tips

When you experience an issue with your TV, turn it off and on again. If this does not resolve the problem, then refer to the tips below. If the problem is still not resolved, then contact us.

ISSUES	POSSIBLE SOLUTIONS
No sound or picture	<ul style="list-style-type: none"> • Check if the power cord is plugged into a powered AC outlet. • Press the [] button on the remote control to activate the unit from 'Standby' mode. • Check to see if the LED light is on or not. If it is, then the TV is receiving power.
I have connected an external source to my TV and I get no picture and/or sound	<ul style="list-style-type: none"> • Check for the correct output connection on the external source and for the correct input connection on the TV. • Make sure you have made the correct selection for the input mode for the incoming signal.
When I turn on my TV, there is a delay for a few seconds before the picture appears. Is this normal?	<ul style="list-style-type: none"> • Yes, this is normal. The TV is initializing and searching for previous setting information.
The picture is normal but there is no sound	<ul style="list-style-type: none"> • Check the volume settings. • Check if 'Mute' mode is set to On. • Check if the Settings-Sound-Speakers is set to the correct settings. • Check the external audio device is power on. • Check Settings-Sound-Advanced audio is set to correct format which your external audio device can support.
Sound but no picture or black and white picture	<ul style="list-style-type: none"> • If the picture is black and white, unplug the TV from the AC outlet and replug it after 60 seconds. • Check that the Color is set to 50 or higher. • Try different TV channels. • Check if set to Audio Only mode.
The sound and/or picture is distorted or appears wavy	<ul style="list-style-type: none"> • An electric appliance may be affecting the TV. Turn off any appliances that are nearby and move it farther away from the TV. • Insert the power plug of the TV set into another power outlet.
The sound and picture is blurry or cuts out	<ul style="list-style-type: none"> • If using an external antenna, check the direction, position and connection of the antenna. • Adjust the direction of your antenna or reset or fine tune the channel. • Check if the Oversan is set to off • Try different picture mode
A horizontal or vertical stripe appears on the picture and/or the picture is shaking	<ul style="list-style-type: none"> • Check if there is an appliance or electric tool nearby that is causing interference.
The plastic cabinet makes a "clicking" type of sound	<ul style="list-style-type: none"> • The 'click' sound can occur when the temperature of the television changes. This change causes the television cabinet to expand or contract, which makes the sound. This is normal and the TV is OK.
The remote control does not work	<ul style="list-style-type: none"> • Confirm that TV still has power and is operational. • Change the batteries in the remote control. • Check if the batteries are correctly installed. • Check if the remote is paired.

The picture is blurred or shows a distorted image in the shape of a snowflake	<ul style="list-style-type: none"> • Power off the TV and check to see if the Lens is dirty. If it is, then follow the instructions in your QSG to clean it and the screen.
The picture does not fit the screen	<ul style="list-style-type: none"> • Check if the screen or projector is moved and move it back. • Follow the Quick Start Guide to adjust the laser TV. • Use Settings-Screen-Geometry to adjust the picture.
The TV is displaying an 'Overheat' warning message	<ul style="list-style-type: none"> • Check to make sure the vents on the left and right side of the TV are clear. • Check to make sure no heat source is too close to the TV.
The picture appears on the screen intermittently	<ul style="list-style-type: none"> • The TV has an eye protection feature for your safety. If you walk too close to the TV while it is on, the laser source will turn off and then turn back on when you move away from it
The picture is washed out or lacks color	<ul style="list-style-type: none"> • The TV screen can reject the ambient light from the top. Check if any light affect the screen from the bottom. Remove the light source from the lower position.

 **NOTE**

- For usage in Mexico , operation of this equipment is subject to the following two conditions : 1) it is possible that this device doesn't cause any detrimental interference and 2) this device must take any kind of interference, including that which may cause its malfunctioning.