

## QUICK SETUP GUIDE

## Bluetooth Receiver

NS-CAHBTAD

*Designed for use with Beats Studio and Solo.*

## PACKAGE CONTENTS

- Bluetooth receiver
- Micro USB cable
- Foam spacer
- *Quick Setup Guide*

## FEATURES

Inside view

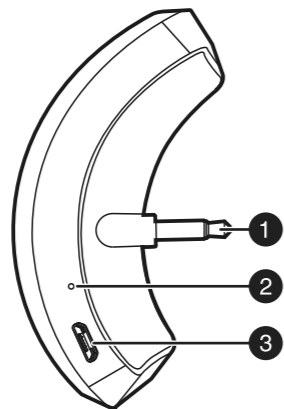

- 1 3.5 mm headphone plug
- 2 Microphone
- 3 Micro USB charging port

Outside view

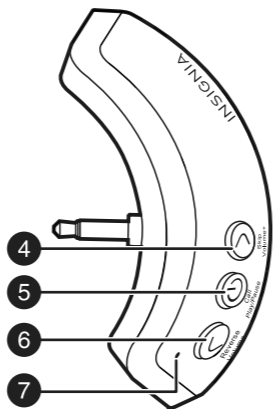

- 4 Volume up/Next
- 5 Multi-function button (MFB): Power on/off, play, pause, call
- 6 Volume down/Previous
- 7 LED indicator

## CHARGING YOUR RECEIVER

Fully charge your receiver before you use it for the first time. When the red LED starts to blink during use, the battery is low and needs charging.

- 1 Plug the micro USB end (small plug) on the USB cable into the micro USB port on your receiver.
- 2 Plug the USB end (large plug) on the cable into an active USB port or any USB charger. The LED lights red while charging. When fully charged, the LED turns off. Charging may take up to three hours.

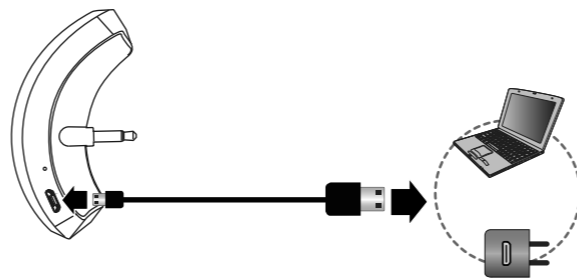

- 3 When charging is complete, unplug the USB cable from your receiver. Your receiver is ready to use.

## PAIRING YOUR RECEIVER

To get started, you need to pair your receiver with your phone or device.

- 1 With your receiver turned off, press and hold the MFB (power icon) until the LED starts flashing blue (about three to five seconds). Your receiver turns on and enters pairing mode.
- 2 Turn on the Bluetooth feature on your phone or device, then search for and click your receiver (**NS-CAHBTAD**). See the instructions that came with your Bluetooth device for information about pairing.
- 3 If you are asked for a password, enter **0000**. When pairing is complete, the LED lights solid blue.

## RECONNECTING TO A PAIRED DEVICE

- 1 Turn on your receiver. It automatically connects to the last connected device.
- 2 If your receiver does not automatically reconnect, reselect **NS-CAHBTAD** on your Bluetooth device.

If you want to pair with another device, turn off the Bluetooth feature on the connected device, then repeat the pairing procedure to connect to a new device.

**Note:** If your receiver is not paired to a Bluetooth device for three minutes, it automatically turns off.

## USING YOUR RECEIVER

- 1 Press and hold the MFB (power icon) for three to five seconds to turn on your receiver. The LED lights solid blue when your receiver is connected to a Bluetooth device (for example, your phone).
- 2 Insert the 3.5 mm headphone plug into the 3.5 mm audio jack on your headphones. Make sure that the plug is fully inserted.

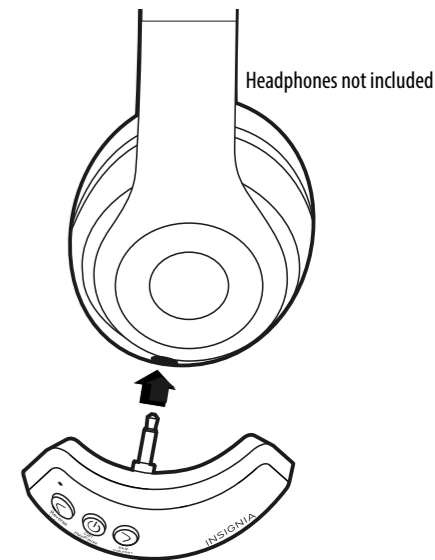

- 3 To turn off your receiver, press and hold the MFB (power icon) for two seconds.

## ADJUSTING THE FIT



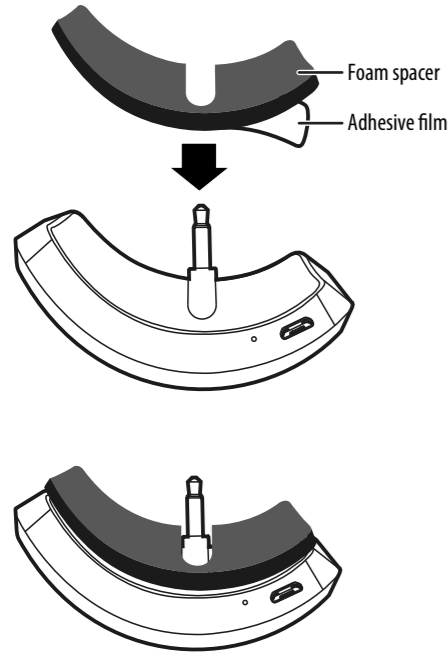

If there is a large gap between your receiver and headphones when you plug in your receiver, use the provided foam spacer to fill the gap.

- 1 If your receiver is plugged into headphones, unplug it.
- 2 Peel off the adhesive film on the foam spacer, then attach the foam spacer to your receiver.





- 3 Plug your receiver back to the headphones.

## LISTENING TO MUSIC

- To play or pause audio, press the MFB  once.
- To increase the volume, press the  button once.
- To reduce the volume, press the  button once.
- To skip to the next track, press and hold .
- To skip to the previous track, press and hold .

## MAKING A PHONE CALL

- To make a call, use your phone's controls, then select your receiver as the audio source.
- To answer an incoming call, press the MFB .
- To reject an incoming call, press and hold the MFB .
- To end a call, press the MFB  once.

## TROUBLESHOOTING

PROBLEM	SOLUTION
No sound or low volume	<ul style="list-style-type: none"><li>• Make sure that your Bluetooth device is turned on, the Bluetooth feature is turned on, and <b>NS-CAHBTAD</b> is selected.</li><li>• Turn up the volume on your receiver and Bluetooth device.</li><li>• Make sure that your Bluetooth device is not muted.</li><li>• Make sure that your receiver and Bluetooth device are not paired to other devices.</li></ul>
Cannot connect with Bluetooth	<ul style="list-style-type: none"><li>• Shorten the distance between your receiver and Bluetooth device.</li><li>• Turn your receiver and device off, then back on. Re-pair your receiver and Bluetooth device.</li><li>• Make sure that your receiver and Bluetooth device are not paired to other devices.</li><li>• Make sure that you have selected <b>NS-CAHBTAD</b> on your Bluetooth device.</li><li>• Make sure that your Bluetooth device supports the HSP, HFP, A2DP, or AVRCP Bluetooth protocol.</li></ul>
Bluetooth device keeps unpairing	<ul style="list-style-type: none"><li>• Shorten the distance between your receiver and Bluetooth device.</li><li>• Recharge the batteries in your receiver and Bluetooth device.</li></ul>
<b>NS-CAHBTAD</b> does not appear on my Bluetooth device	<ul style="list-style-type: none"><li>• Shorten the distance between your receiver and Bluetooth device.</li><li>• Put your receiver into pairing mode (see <i>PAIRING YOUR RECEIVER</i>), then, on your Bluetooth device, refresh the list of Bluetooth devices. (See the documentation that came with your Bluetooth device.)</li></ul>
No power	<ul style="list-style-type: none"><li>• Make sure that your receiver's battery is charged. See <i>CHARGING YOUR RECEIVER</i>.</li><li>• Make sure that your receiver is turned on. See <i>USING YOUR RECEIVER</i>.</li></ul>

## LEGAL NOTICES

### FCC Statement:

This equipment has been tested and found to comply with the limits for a Class B digital device, pursuant to part 15 of the FCC Rules. These limits are designed to provide reasonable protection against harmful interference in a residential installation. This equipment generates, uses and can radiate radio frequency energy and, if not installed and used in accordance with the instructions, may cause harmful interference to radio communications. However, there is no guarantee that interference will not occur in a particular installation. If this equipment does cause harmful interference to radio or television reception, which can be determined by turning the equipment off and on, the user is encouraged to try to correct the interference by one or more of the following measures:

- Reorient or relocate the receiving antenna.
- Increase the separation between the equipment and receiver.
- Connect the equipment into an outlet on a circuit different from that to which the receiver is connected.
- Consult the dealer or an experienced radio/TV technician for help.

This device complies with part 15 of the FCC Rules. Operation is subject to the following two conditions: (1) This device may not cause harmful interference, and (2) this device must accept any interference received, including interference that may cause undesired operation.

**Caution:** Changes or modifications not expressly approved by the party responsible for compliance could void the user's authority to operate the equipment.

### RSS-Gen & RSS-247 statement:

This device complies with Industry Canada licence-exempt RSS standard(s).

Operation is subject to the following two conditions: (1) this device may not cause interference, and (2) this device must accept any interference, including interference that may cause undesired operation of the device.

Le présent appareil est conforme aux CNR d'Industrie Canada applicables aux appareils radio exempts de licence. L'exploitation est autorisée aux deux conditions suivantes : (1) l'appareil ne doit pas produire de brouillage, et (2) l'utilisateur de l'appareil doit accepter tout brouillage radioélectrique subi, même si le brouillage est susceptible d'en compromettre le fonctionnement.

### RSS-102 Statement:

This equipment complies with Industry Canada radiation exposure limits set forth for an uncontrolled environment. Cet équipement est conforme à l'exposition aux rayonnements Industry Canada limites établies pour un environnement non contrôlé.

## ONE-YEAR LIMITED WARRANTY

Visit [www.insigniaproducts.com](http://www.insigniaproducts.com) for details.

## CONTACT INSIGNIA:

For customer service, call 877-467-4289  
[www.insigniaproducts.com](http://www.insigniaproducts.com)

INSIGNIA is a trademark of Best Buy and its affiliated companies  
Distributed by Best Buy Purchasing, LLC  
7601 Penn Ave South, Richfield, MN 55423 U.S.A.  
©2017 Best Buy. All rights reserved  
**Made in China**