

# Hisense

## Quick Start Guide

### 2.0 Channel Sound Bar Home Theater System

Model: HS205



**Roku TV Ready**

- ✓ Simple setup
- ✓ One remote
- ✓ Quick settings



## What's in the Box



Main Unit

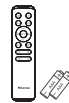

Remote Control / AAA Batteries x 2



Optical Cable



HDMI Cable



Bracket(x2) / Wall Plug(x2) / screw(x2) / bracket screw(x2)

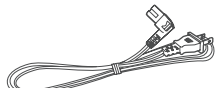

AC Power Cord



User Manual/Quick Start Guide/Wall Mount Guide

## 1 Remote control

- ① **⏻** Switch the unit between ON and STANDBY mode.
- ② **🔇 (MUTE)** Mute or resume the sound.
- ③ **MOVIE** Switch to MOVIE EQ effect.
- ④ **MUSIC** Switch to MUSIC EQ effect.
- ⑤ **VOL+/VOL-** Increase/decrease the volume level.
- ⑥ **⏮/⏭** Skip to previous/next track in Bluetooth/USB mode.
- ⑦ **⏸/PAIR** Play/pause/resume playback in Bluetooth/USB mode. Press and hold to activate the pairing function in Bluetooth mode or disconnect the existing paired Bluetooth device.
- ⑧ **NEWS** Switch to NEWS EQ effect.
- ⑨ **HDMI ARC** Select the HDMI ARC mode.
- ⑩ **OPT/COAX** Select the OPTICAL/COAXIAL mode.
- ⑪ **(BT)** Select the Bluetooth mode.
- ⑫ **LINE IN** Select the LINE IN mode.
- ⑬ **USB** Select the USB mode.

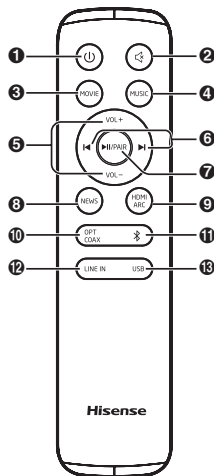

### Replace the Remote Control Battery

- 1 Press and slide the back cover to open the battery compartment of the remote control.
- 2 Insert two AAA size batteries (included). Make sure the (+) and (-) ends of the batteries match the (+) and (-) ends indicated in the battery compartment.
- 3 Close the battery compartment cover.

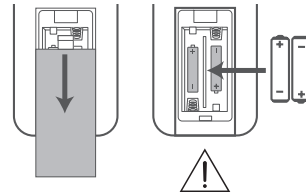

- Do not mix old and new batteries;
- Do not mix alkaline, standard (Carbon-Zinc) or rechargeable (Ni-Cd, Ni-MH, etc.) batteries.

## 2 Identifying the Parts

### Main Unit

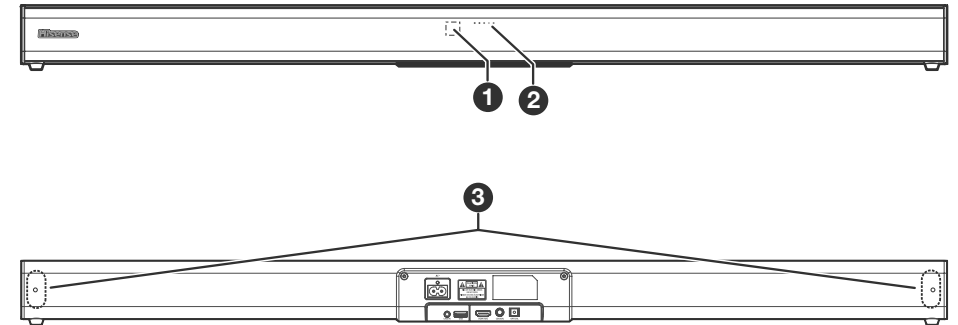

#### 1 Remote Control Sensor

Receive signal from the remote control.

#### 2 LED Indicators

- Red : In **STANDBY** mode.
- Orange / Orange flash : In **Optical / Coaxial** mode.
- Blue : In **Bluetooth** mode.
- White : In **HDMI ARC** mode.
- Green / Green flash : In **LINE IN / USB** mode.

#### 3 Screws

Remove the screws then install the wall mounting screws into the back of the unit.

#### 4 **⏻ (ON/OFF)** Button

Switch the unit between ON and Standby mode.

#### 5 **+/- (Vol+/Vol-)** Buttons

Increase/decrease the volume level.

#### 6 **☑ (SOURCE)** Button

Select the play function.

#### 7 **AC~** Socket

Connect to the power supply.

#### 8 **LINE IN** Socket

Connect to an external audio device.

#### 9 **USB** Socket

Insert the USB device to play music.

#### 10 **HDMI ARC** Socket

Connect to a TV via HDMI cable.

#### 11 **COAXIAL** Socket

Connect to a coaxial audio output on the TV.

#### 12 **OPTICAL** Socket

Connect to an optical audio output on the TV.

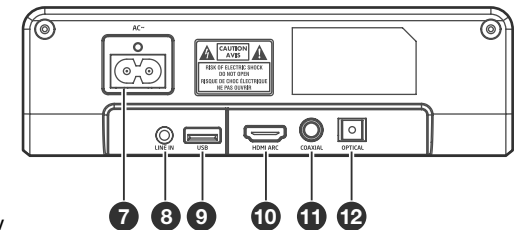
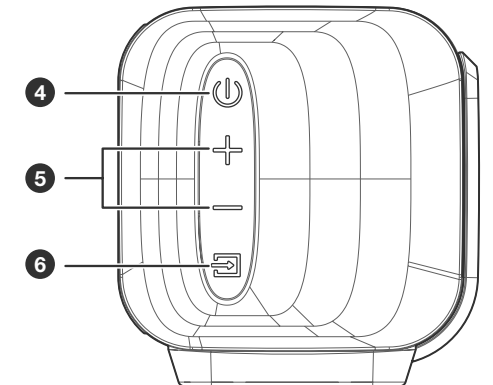

### 3 Connections

• Before connecting the AC power cord, ensure you have completed all other connections.

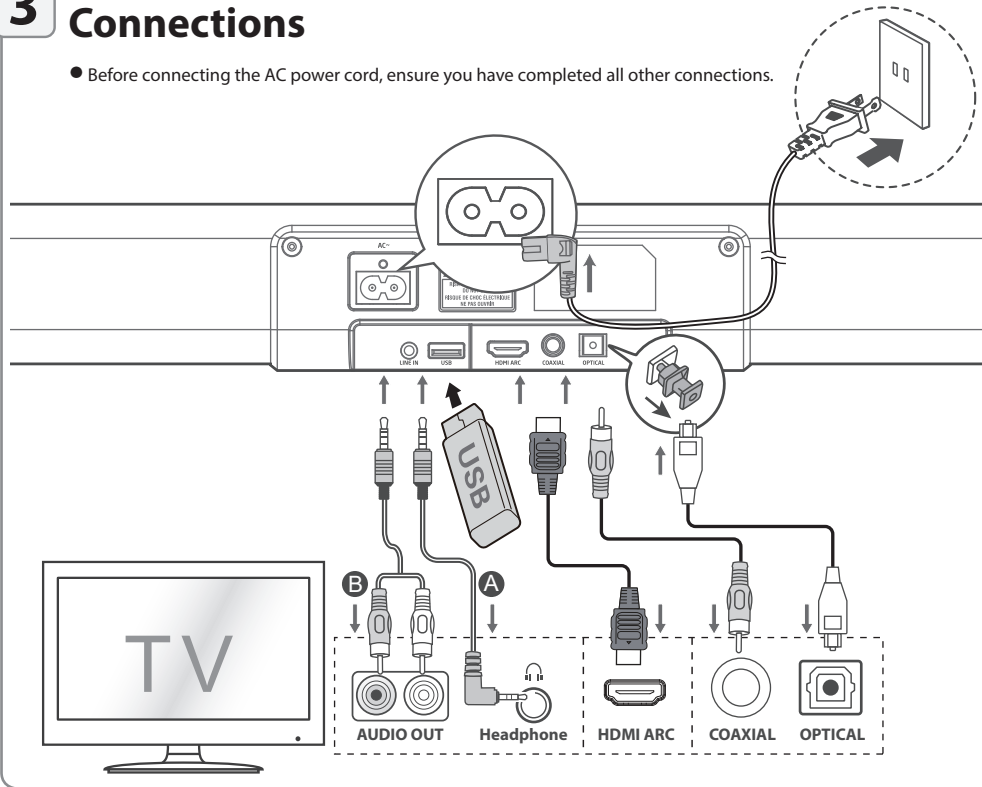

### 4 Basic Operation

#### Standby/ON

When you first connect the main unit to the mains socket, the main unit will be in Standby mode.

- Press the **⏻** button on the unit or on the remote control to switch the unit ON.
- Press the **⏻** button again to switch the unit back to STANDBY mode.
- Disconnect the mains plug from the mains socket if you want to switch the unit OFF completely.

#### Auto Wake

If a TV or an external device is connected (LINE IN / OPTICAL / COAXIAL / HDMI ARC), the unit will switch on automatically when the TV or the external device is switched on.

#### Automatic Power Off Function

The unit automatically turns to Standby mode after about 15 minutes if the TV or the external unit is disconnected, switched off.

- To switch the unit off completely, remove the mains plug from the mains socket.
- Please turn the unit off completely to save energy when not in use.

#### Select Modes

Press the **⏻** (SOURCE) button repeatedly on the unit or the HDMI ARC, **📶** (Bluetooth), OPT/COAX, USB and LINE IN buttons on the remote control to select the desired mode. The indicator light on the front of the main unit will show which mode is currently in use.

#### Adjust the Volume

Press the **VOL+** / **VOL-** buttons on the unit or on the remote control to adjust the volume. If you wish to turn the sound off, press the **🔇** (MUTE) button on the remote control. Press the **🔇** (MUTE) button again or press the **VOL+** / **VOL-** buttons on the unit or on the remote control to resume normal listening.

#### Select a Preset Sound Effect

While playing, press the **NEWS / MOVIE / MUSIC** buttons on the remote control to select the preset equalizers:

- MOVIE (recommended for viewing movie)
- MUSIC (recommended for listening to music)
- NEWS (recommended for listening to news)

### 5 Bluetooth(📶) Operation

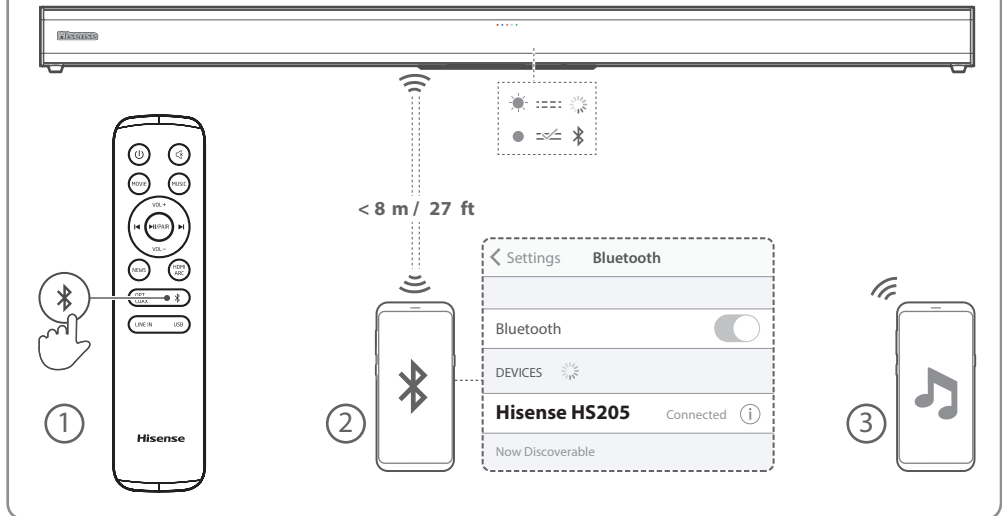

### 6 Wall Mounting

