

Portable Evaporative Air Cooler  
User Manual  
Read and save these instructions before use

**Product video:**



[www.honeywellaircoolers.com/products/CS10XE](http://www.honeywellaircoolers.com/products/CS10XE)

[www.jmatek.com](http://www.jmatek.com)  
E-mail: [usinfo@jmatek.com](mailto:usinfo@jmatek.com)

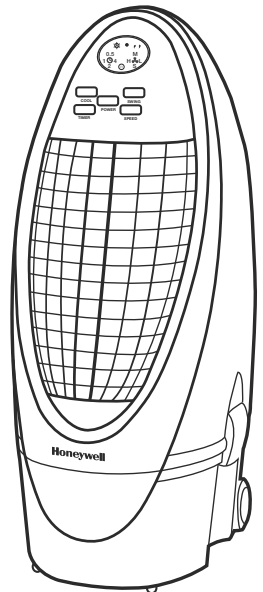

**Model:  
CS10XE**

# PARTS DESCRIPTION

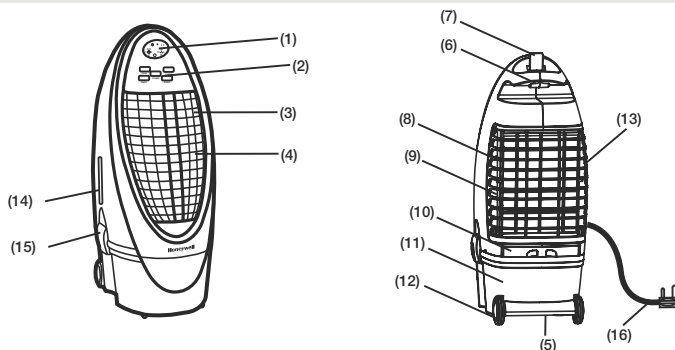

- |                   |                            |                                 |
|-------------------|----------------------------|---------------------------------|
| 1) Display Screen | 7) Remote Control          | 13) Carbon Dust Filter          |
| 2) Control Panel  | 8) Honeycomb Cooling Media | 14) Water Level Indicator       |
| 3) Louvers        | 9) Rear Grill              | 15) Detachable Water Tank Latch |
| 4) Front Grill    | 10) Water Fill Tray        | 16) Power Cord & Plug           |
| 5) Drain Plug     | 11) Water Tank             |                                 |
| 6) Handle         | 12) Castors                |                                 |

**WARNING -- READ AND SAVE THE AIR COOLER SAFETY & MAINTENANCE GUIDE AND USER MANUAL BEFORE USING THIS PRODUCT. FAILURE TO FOLLOW THESE INSTRUCTIONS MAY DAMAGE AND/ OR IMPAIR ITS OPERATION AND VOID THE WARRANTY. IN CASE THERE IS ANY INCONSISTENCY OR CONFLICT BETWEEN THE ENGLISH VERSION AND ANY OTHER LANGUAGE VERSION OF THE CONTENT OF THIS MATERIAL, THE ENGLISH VERSION SHALL PREVAIL.**

## USE & OPERATION

### CONTROL PANEL

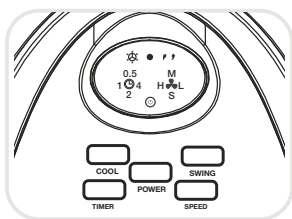

Icons on Display Screen



Cool



Swing



Fan Speed:

L - Low  
M - Medium  
H - High  
S - Sleep\*



Power ON / OFF



Timer Setting

\*Applicable for models with Sleep feature only.

### FUNCTION BUTTONS

#### POWER

Press the **POWER** button to turn the unit on. The cooler will start automatically at medium speed. After a few seconds the speed will switch to low. To turn the unit off, press the button again.

#### SPEED

Press the **SPEED** button repeatedly to change the speed between H - M - L - S\*.  
The indicator light will show the selected speed:

High (H) ↔ Medium (M) ↔ Low (L) ↔ Sleep (S)\*

When the **SLEEP** mode is selected, the fan will run on High for one hour, then Medium for the second hour and on Low speed from the third hour onwards until you switch off the unit.

## FUNCTION BUTTONS (CONTINUED)

### TIMER

Press the TIMER button until the desired time duration setting is selected. When the set time has passed, the unit will automatically turn off (unit remains in Standby mode until power cord is unplugged from electrical socket). The TIMER function allows you to program the unit for up to 7.5 hours of use.

### SWING

Press the SWING button until  is illuminated on the display screen. The louvers will begin to move left to right automatically.

Vertical Air Flow - You can manually adjust the louvers to change vertical air flow.

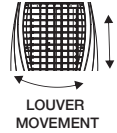





### COOL

Press the COOL button until  is illuminated on the display screen. This activates evaporative cooling. The water pump will operate and you will feel the cooler air after the Honeycomb Cooling Media is completely wet.

**WARNING:** Please ensure sufficient water is in the water tank otherwise you may hear a Low Water Alarm and the cooler will start in a Fan only mode without evaporative cooling.

## REMOTE CONTROL



-  Power : ON / OFF
-  Speed : Low / Medium / High / Sleep\*
-  Cool : Evaporative cooling ON / OFF
-  Swing : Controls the motion of the louvers
-  Timer : Controls the Timer function for automatic off

\*Applicable for models with Sleep feature only.

### Note:

- The remote control requires a CR2032 (1 x 3V) coin type or equivalent battery for replacement.
- Open the battery compartment at the back of the remote control and insert the battery inside. Care must be taken to insert the batteries according to the correct polarity (+ / -) markings shown inside the battery compartment.
- Always point the remote control signal transmitter towards the unit when operating. Make sure that the signal path is not obstructed.
- Remove the batteries if the unit is not going to be used for an extended period of time.
- Do not drop the remote control.
- Do not mix different types of batteries such as alkaline, carbon-zinc, or rechargeable batteries.
- Do not mix old and new batteries.
- Do not recharge the battery.
- Exhausted batteries are to be removed from the product and safely disposed of as per local regulations.
- Do not dispose of batteries in fire. Batteries may explode or leak.

**WARNING:** Caution for ingestion of the small battery. Keep away from children and animals.

## COOLER LOCATION

Make sure to position the air cooler correctly before you set up and start using the product. Please refer to the COOLER LOCATION section of the separate Safety & Maintenance Guide.

## FILLING WITH WATER

### CAUTION:

Unplug the unit from the electrical power outlet before emptying or refilling the water tank.

Open the Water Fill Tray located at the back of the unit. The Water Level Indicator is located at the side of the unit. Refill the water tank when water level is low. Do not fill water above the "Max." water level mark to avoid water droplets collecting on the louvers. Check the water level in the tank before running the  COOL function. Make sure that the water in the tank is above the minimum water level mark. Running the unit in COOL mode with inadequate water may cause pump failure.

**Note:** The water capacity refers to the total volume of water that can be contained within the air cooler water tank and water distribution system. The water capacity in the tank at the "Max." indicator level may be lower than the actual water capacity of the air cooler.

## LOW WATER ALARM

The unit is equipped with a low water sensor. In Cooling Mode, when water in the tank is below the minimum level, you will hear a beeping sound and the  will flash continuously. The unit will automatically pause evaporative cooling.

Refill the water tank to deactivate the alarm in cooling mode. First switch OFF the unit and unplug from the power outlet. Fill the water tank with water above the minimum water level mark. Plug in and switch ON again.

To deactivate the alarm and continue using the unit as a fan (without evaporative cooling), switch the unit OFF and then ON again. The Low Water Alarm will not activate in Fan only mode. The Low Water Alarm will sound again if the COOL function is activated while the water tank is still empty.

## CLEANING & DRAINING THE WATER TANK

Below are instructions on how to clean and maintain your air cooler. If the cooler will not be used for a long period of time, please refer to the STORAGE & MAINTENANCE GUIDELINES located in the separate Safety & Maintenance Guide.

### WARNING:

Before cleaning the unit, switch the unit OFF and disconnect from the electrical socket.

- Move the unit to a location where the water can be drained. Remove the cap from the Drain plug located at the bottom of the unit. Allow the tank to empty.
- Detach the water tank by unlocking the Detachable Water Tank Latches on both sides of the unit. Lift the cooler upwards away from the base and place it carefully and vertically on the floor. Be careful not to bend the water pump tubes and other parts that will hang from the bottom of the unit when the body is removed from the tank.
- Refill the water tank with clean water and drain it completely. Clean the water tank with dish detergent or a damp cloth and rinse it thoroughly.
- Refill the water tank with clean water, up to the maximum level.
- Replace the top of the air cooler carefully back onto the tank and lock the side latches. The air cooler is now ready to be used.
- Use a damp cloth to remove dirt and dust from the surface of the unit. Never use corrosive elements or chemicals to clean this product.
- When the product is not in use, store the unit in a dry place out of direct sunlight.

## CLEANING THE CARBON DUST FILTER\* AND HONEYCOMB COOLING MEDIA

- The appliance is supplied with a Carbon Dust Filter\* and Honeycomb Cooling Media.
- The Carbon Dust Filter\* and Honeycomb Cooling Media are located inside the Rear Grill. See Figure 1 for instructions on how to remove them from the unit for cleaning and maintenance.
- Do not run the unit in COOL mode with stale water in the tank. You must empty the water tank and refill with fresh water, especially if the tank has not been cleaned in a long time.
- The cleaning frequency for the Honeycomb media depends on local air and water conditions. In areas where the mineral content of water is high, mineral deposits may build up on the Honeycomb Cooling Media and restrict air flow. Draining the water tank and refilling with fresh water at least once a week will help reduce mineral deposits. If mineral deposits remain on the Honeycomb Cooling Media, the media should be removed and washed under fresh water. The media should be cleaned every two months or sooner, depending on your needs.
- For best results allow the Honeycomb Cooling Media to dry after each use by turning off the cool function 15 minutes before turning the unit off.

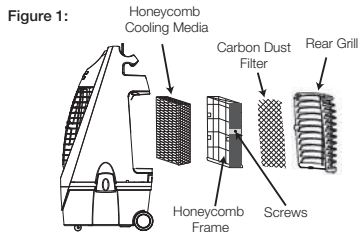

Removing the Carbon Dust Filter\*/ Honeycomb Cooling Media:

1. Remove all the screws from the Rear Grill of the Air Cooler.
2. Carefully pull out the rear grill from the cooler.
3. Slide out the Carbon Dust Filter\* and clean with water.
4. To release the Honeycomb Media, remove the Honeycomb Frame screws and pull the Honeycomb Frame out of the unit.
5. Remove the screws on the base of the Honeycomb Frame and slide out the Honeycomb Cooling media. Replace or clean media with water and a damp cloth as needed.

**WARNING:** DO NOT operate the Air Cooler when the Rear Grill is removed from the Air Cooler, or if there is a loose-fitting Rear Grill. Doing so can cause serious injury or dangerous electrical shock.

\*Applicable for models with Carbon Dust Filter only.

# TECHNICAL SPECIFICATIONS

Model	CS10XE
Voltage	110 - 120 V
Frequency	60 Hz
Ampere	0.85 A
Wattage	102 W
Water Capacity	10 Litres / Litros 2.6 Gallons / Galones
Cooling Media	Honeycomb
Product Dimension	344 (W) x 400 (D) x 800 (H) mm 13.5 (W) x 15.7 (D) x 31.5 (H) in
Net Weight	8.4 kg / 18.5 lbs

## ELECTRICAL WIRING DIAGRAM

Version: 110 - 120V/60Hz

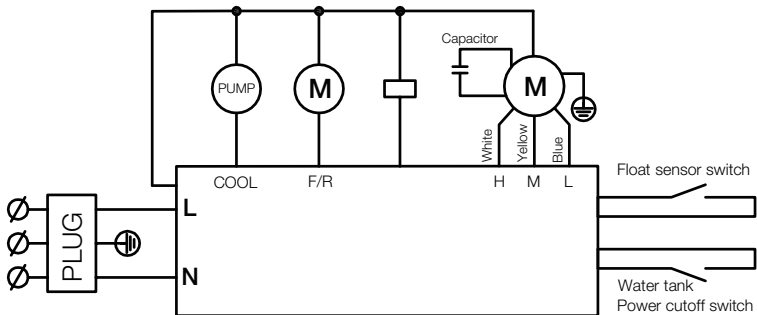

**JMATEK North America LLC**  
Mahwah, New Jersey 07495 USA  
Phone: 1-800-474-2147  
Email: [usinfo@jmatek.com](mailto:usinfo@jmatek.com)  
Web: [www.jmatek.com](http://www.jmatek.com)

© 2016 JMATEK Limited. All rights reserved.  
The Honeywell Trademark is used under license from  
Honeywell International Inc.  
Honeywell International Inc. makes no representations  
or warranties with respect to these products.  
This product is manufactured by Airtek Int'l Corp. Ltd.  
(subsidiary of JMATEK Ltd.)

**Honeywell**