



E.FLEX 50 PORTABLE SOLAR PANEL

Model: R50EF

➤ User Guide

TABLE OF CONTENTS

IMPORTANT SAFETY INSTRUCTIONS	03
FEATURES	03
PACKAGE CONTENTS	04
PRODUCT OVERVIEW	04
SPECIFICATIONS	05
OPERATIONS	05
TROUBLESHOOTING	08
WARRANTY	09

IMPORTANT SAFETY INSTRUCTIONS

Please read the User Guide carefully before operating your E.FLEX 50.

IMPORTANT SYMBOLS

WARNING

Indicates potentially dangerous conditions that could result in personal injury

CAUTION

Indicates conditions or practices that could result in damages to the unit or other equipment

NOTE

Indicates procedures or functions that are important for proper and safe operation of the unit and/or other equipment

WARNING

DO NOT disassemble the unit or remove any attached components. Incorrect reassembly may result in a risk of fire or electric shock.

WARNING

Keep the unit out of reach of children unless supervised by an adult.

WARNING

DO NOT operate the unit if it has been smashed, pierced, or otherwise damaged in any way.

WARNING

DO NOT place the unit on a surface constructed from combustible material. Keep the unit away from explosives and corrosive substances.

WARNING

DO NOT store the unit near heat sources or apply direct heat to it.

CAUTION

The unit is designed to withstand splashes and spills but is not fully waterproof. DO NOT submerge the unit in water or leave it in the rain.

CAUTION

Dispose of the unit according to the local recycling and environmental regulations.

CAUTION

DO NOT step, walk, stand, or jump on the unit. Localized heavy loads may cause variances of micro-cracks on the solar cells, which will ultimately compromise the reliability of the unit.

CAUTION

DO NOT bend the unit. Doing so may break the solar cells.

NOTE

Please use a wet sponge or cloth to clean the unit as necessary. A mild, non-abrasive cleaning agent can be used to remove grime and dirt.

FEATURES

HIGHLY EFFICIENT

Premium solar cells with an energy conversion efficiency of up to 21%~23% guarantee sufficient power output in all daylight conditions.

UNIVERSAL COMPATIBILITY

The voltage switchable DC output port, USB port, and USB-C port are ready to charge smart phones, tablets, and laptops. Solar panel connectors are available for rechargeable power supplies.

OPTIMIZED CHARGING

An intelligent chip automatically identifies connected devices and adjusts output current to offer the fastest possible charging speed.

SUPERIOR DURABILITY

Industrial-strength PET polymers and rugged polyester canvas provide lasting durability to protect against unpredictable weather conditions.

PACKAGE CONTENTS

- 1 x Renogy E.FLEX 50 Portable Solar Panel
- 1 x Solar Panel Connectors to 5.5mm DC Adapter Cable
- 1 x 5.5mm DC to 5.5mm DC Power Cable
- 8 x 5.5mm DC Adapter Connectors
- 1 x User Guide

PRODUCT OVERVIEW

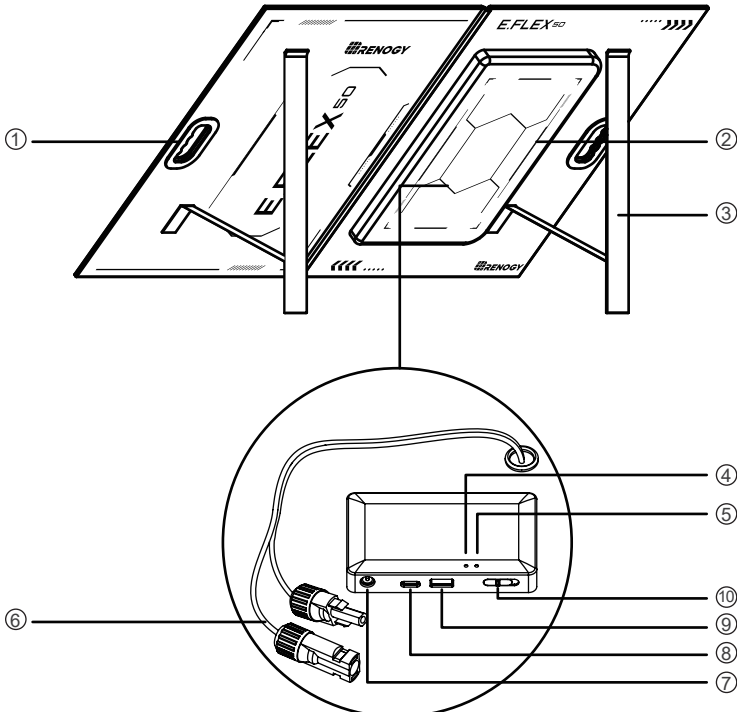

- ① Handle
- ② Pouch Bag
- ③ Kickstand
- ④ LED Indicator 1
- ⑤ LED Indicator 2
- ⑥ Solar Panel Connectors
- ⑦ DC Output Port
- ⑧ USB-C Port
- ⑨ USB-A Port
- ⑩ Slide Switch

SPECIFICATIONS

General	
Weight	5.25 lb. / 2.38 kg
Dimensions (Folded)	19.9 x 16.1 x 0.8 inch / 506 x 408 x 20 mm
Dimensions (Unfolded)	32.5 x 19.9 x 0.2 inch / 826 x 506 x 5 mm
Solar Panel	
Rated Power	50W
Open Circuit Voltage	21.6V
Short Circuit Current	3.04A
Optimum Operating Voltage	18V
Optimum Operating Current	2.77A
Solar Cell	Monocrystalline
Output	
DC Output Port	19V / 2.4A, 16V / 2.8A Max
USB-A Port	5V / 2.4A Max
USB-C Port	5V / 3A Max
Solar Panel Connectors	18V / 2.77A Max

OPERATIONS

- Place the E.FLEX 50 under direct sunlight and adjust the angle for maximum exposure. Steer clear of trees or branches that can shade the E.FLEX 50 and slow down the charging process.
- To charge PHOENIX 200/300 Power Stations, please connect the E.FLEX 50's Solar Panel Connectors to the DC Input Port of the PHOENIX 200/300 Power Station using the included Solar Panel Connectors to 5.5mm DC Adapter Cable. The E.FLEX 50 will begin to charge the PHOENIX 200/300 Power Station automatically and one of the Battery Level LED Indicators on the PHOENIX 200/300 Power Station will flash to indicate the current battery level.

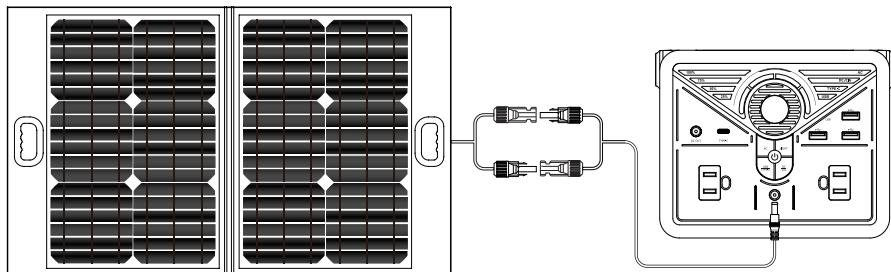

CAUTION

Please place the PHOENIX 200/300 Power Station in the shade to prevent it from overheating.

NOTE

The E.FLEX 50 can charge rechargeable power supplies from other manufacturers as long as they accept 18V DC input. The included 5.5mm DC Adapter Connectors may be used with the Solar Panel Connectors to 5.5mm DC Adapter Cable to connect the E.FLEX 50 to the rechargeable power supply. Please follow the instructions provided by the manufacturer of the rechargeable power supply.

- To charge smart phones, tablets, action cameras, or other USB enabled devices, please connect the device to the E.FLEX 50's USB-A Port using a USB charging cable (not included).

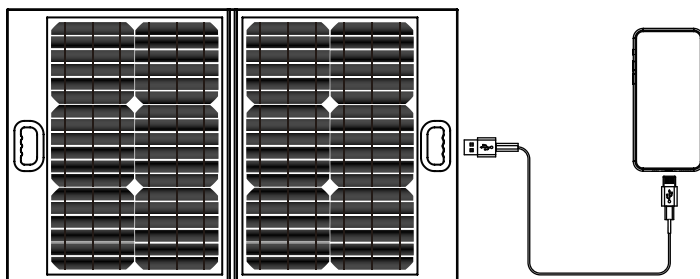

- To charge handheld gaming consoles, DSLR cameras, or other USB-C enabled devices, please slide the Slide Switch to the left position and connect the device to the E.FLEX 50's USB-C Port using a USB-C charging cable (not included).

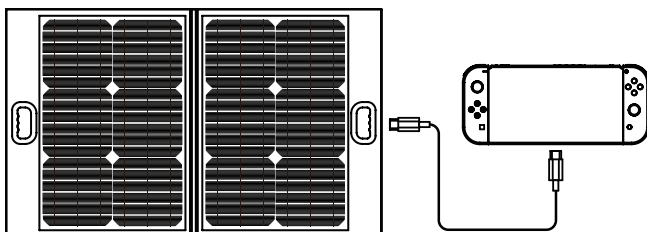
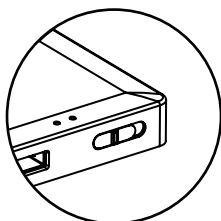

NOTE

The USB-C Port of the E.FLEX 50 does not support the Power Delivery (PD) protocol and cannot charge USB-C laptops.

- To charge laptops, please first select the output voltage of the DC Output Port based on the voltage rating of the laptop. Slide the Slide Switch to the middle position for 16V DC output and the LED Indicator 1 will illuminate blue. Slide the Slide Switch to the right position for 19V DC output and both the LED Indicator 1 and LED Indicator 2 will illuminate blue. Then, connect laptop to the E.FLEX 50's DC Output Port using the included 5.5mm DC to 5.5mm DC Power Cable and 5.5mm DC Adapter Connectors.

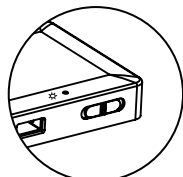

16V DC Output

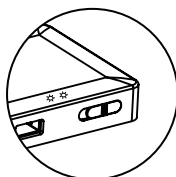

19V DC Output

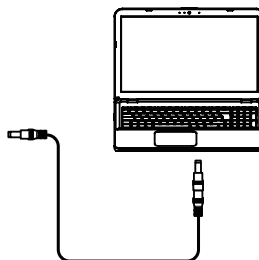
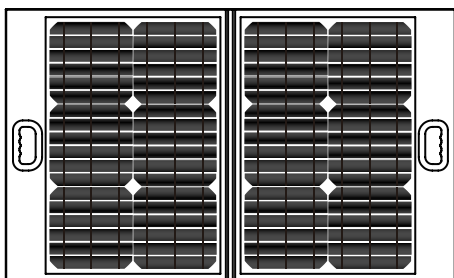
**CAUTION**

Please check the voltage rating of the laptop before charging it. DO NOT charge laptops with voltage ratings other than 16V and 19V. Doing so may damage the laptop.

NOTE

It is highly recommended to shut down the laptop or put it into sleep mode before charging it. The DC Output Port of the E.FLEX 50 may turn on and off frequently if the laptop runs at full capacity while charging.

- To charge batteries, please first connect the Solar Panel Connectors of the E.FLEX 50 to the PV terminals of a charge controller (not included) using adapter cables (not included). Then, connect the BATT terminals of the charge controller to the battery terminals using tray cables (not included). Lastly, set the charging parameters on the charge controller properly. The E.FLEX 50 will begin to charge the battery automatically and the real-time battery level will be displayed on the LCD screen of the charge controller.

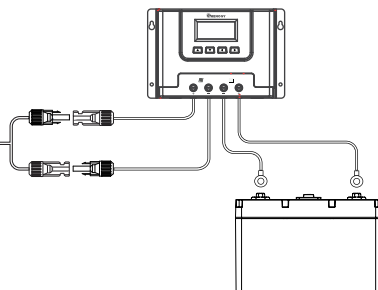
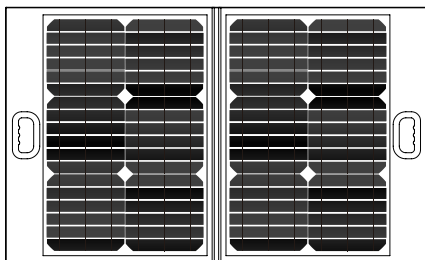

- To expand the output power, please connect multiple E.FLEX 50 in parallel by joining the female and male Solar Panel Connectors of each E.FLEX 50 together with solar parallel branch connectors (not included).

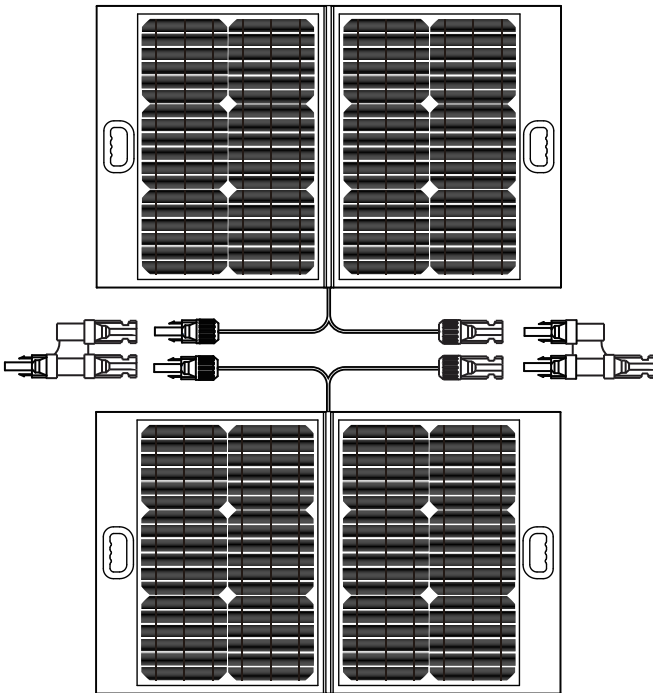

CAUTION

DO NOT connect multiple E.FLEX 50 in series. Doing so may cause irreversible damage to the E.FLEX 50.

TROUBLESHOOTING

- If the E.FLEX 50 does not charge the device connected to it, please check the connection between the E.FLEX 50 and the device. If all the connections are solid, please check if the Slide Switch is in the correct position.
- If the output port of the E.FLEX 50 turns on and off frequently during the charging process, please check if the E.FLEX 50 is receiving enough sunlight and if the device is drawing a large amount of power from the output port. The E.FLEX 50 cannot deliver more power to the device than the amount of solar power it has captured.
- If both the LED Indicator 1 and LED Indicator 2 illuminate red, one or more output ports of the E.FLEX 50 have been shut off due to over-current or short-circuit. Please connect only the devices that conform to the specifications of output ports or remove the short circuit.

WARRANTY





- RENOZY products are covered by a 12-month limited warranty from the original purchase date. If any problems occur, please contact us for assistance. Refer to the last page of User Guide for contact information.
- We only provide after-sales services for products that are sold by RENOZY or retailers and distributors authorized by RENOZY. If you have purchased your unit from other channels, please contact your seller for more information about return and warranty.
- Please register your purchase(s) directly at www.renogy.com/warranty-registration or your region's corresponding website so that we can stay in touch and contact you in the unlikely event that a safety recall is required.

FCC Compliance :

This device complies with Part 15 of the FCC Rules. Operation is subject to the following two conditions: (1) this device may not cause harmful interference, and (2) this device must withstand any interference received, including interference that may cause undesired operation.





Renogy reserves the right to change the contents of this manual without notice.



US |  2775 E Philadelphia St, Ontario, CA 91761, USA
 909-287-7111
 www.renogy.com
 support@renogy.com



CN |  苏州高新区科技城培源路1号5号楼-4
 400-6636-695
 <https://www.renogy.cn>
 support@renogy.cn

JP |  <https://www.renogy.jp>
 supportjp@renogy.com

CA |  <https://ca.renogy.com>
 supportca@renogy.com

AU |  <https://au.renogy.com>
 supportau@renogy.com

UK |  <https://uk.renogy.com>
 supportuk@renogy.com

DE |  <https://de.renogy.com>
 supportde@renogy.com