

Shark® Rocket®

Corded Ultra-Light Vacuum

ZERO-M™

QUICK START GUIDE

WHAT'S INSIDE

- A Handheld Vacuum
- B Zero-M® Cleaner Head
- C Wand
- D 5" Crevice Tool
- E Pet Multi-Tool

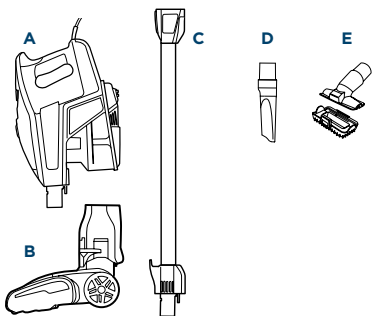

ASSEMBLY

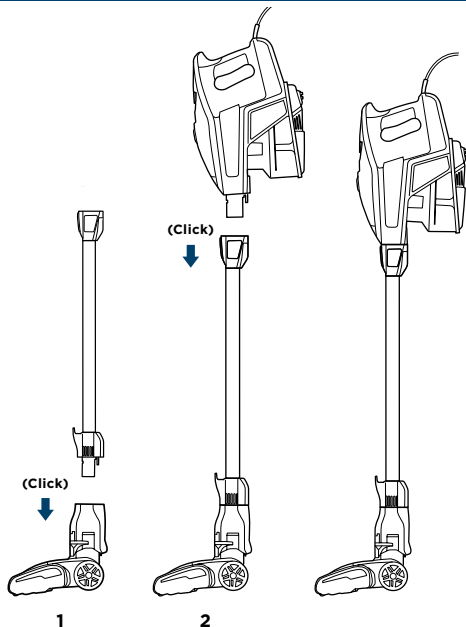

STORAGE

Onboard Hook

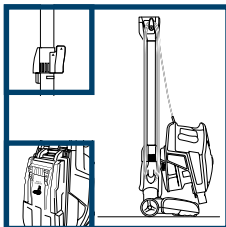

Hang the handheld vacuum on the hook on the bottom of the wand, and wrap the power cord around the cord hooks.

MAINTENANCE

Dust Cup

Empty dust cup every time debris reaches the MAX fill line.

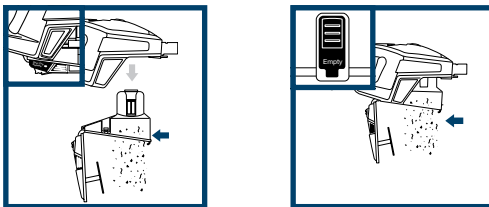

Brushroll Maintenance

The Zero-M cleaner head delivers powerful Shark suction performance while actively removing hair from the brushroll while in use.

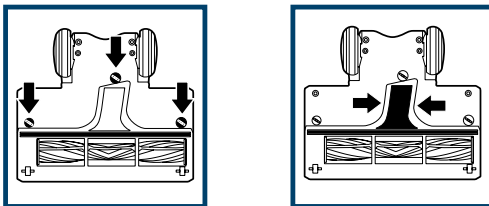

1. Using a coin, turn the locks on the bottom of the cleaner head counterclockwise to open, then lift off cover to access brushroll.
2. Check airway for blockages.
3. Replace cover, pressing down firmly on all sides before turning the locks clockwise to close.

VERSATILE FLOOR-TO-CEILING CLEANING

Settings

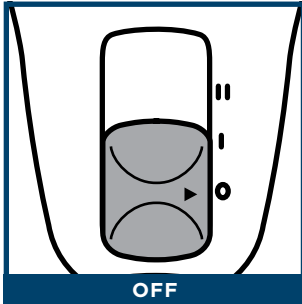

Slide the **Power** switch to the appropriate speed setting.

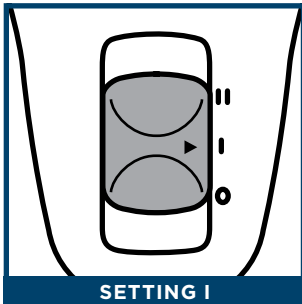

Bare Floor/Small Area Rugs

The brushroll spins slowly to clean bare floors and delicate area rugs.

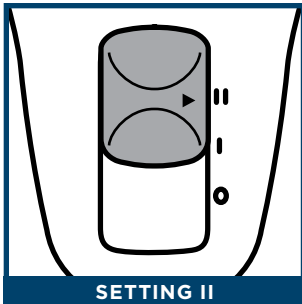

Carpets

The brushroll spins faster to pick up debris below the surface of your carpets.

NOTE: For deep cleaning per ASTM F 608 (embedded dirt in carpets) please use setting II, Carpets.

Upright Mode

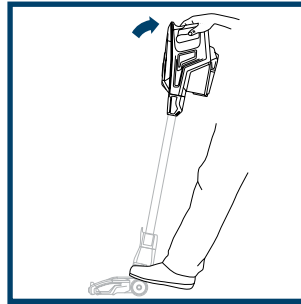

To clean floors, place foot on cleaner head and tilt handheld vacuum back.

Above-Floor Mode

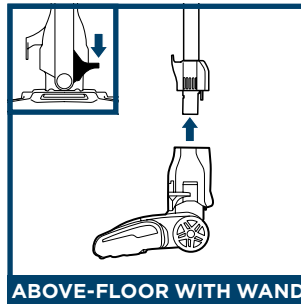

Stand the vacuum upright. Step on the foot pedal and pull the wand up to disconnect it from the cleaner head.

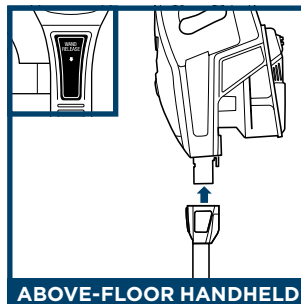

Press the **WAND RELEASE** button and lift the handheld vacuum off the wand.

NOTE: All accessories are compatible with both the wand and the handheld vacuum. Use Setting I for all above-floor accessories.

For additional parts and accessories, visit sharkaccessories.com

For questions or to register your product, visit us online at sharkclean.com



@sharkcleaning