

INSIGNIA™

4.3 Cubic Foot Compact Refrigerator

NS-CF43SS6



Before using your new product, please read these instructions to prevent any damage.

Insignia 4.3 Cubic Foot Compact Refrigerator

Contents

- Introduction2
- Important Safety Instructions.....3
 - Grounding requirement.....5
- Features5
 - Main components6
- Setting up your refrigerator6
 - Before using your refrigerator6
 - Finding a suitable location6
 - Leveling your refrigerator7
 - Providing proper ventilation7
 - Providing a proper power supply.....8
- Setting the thermostat9
- Using the freezer compartment9
 - Making ice.....10
 - Defrosting your refrigerator10
- Reversing the door position10
- Maintaining your refrigerator.....14
 - Changing the interior light14
- Shutting down your refrigerator - long vacations (several months).....15
- Moving Your Refrigerator.....15
- Tips on saving energy15
- Troubleshooting16
- Specifications.....18
- ONE-YEAR LIMITED WARRANTY - INSIGNIA19

Introduction

Congratulations on your purchase of a high-quality Insignia product. Your NS-CF43SS6 represents the state of the art in compact refrigerator design and is designed for reliable and trouble-free performance.

Important Safety Instructions



This symbol indicates that dangerous voltage constituting a risk of electric shock is present within your compact refrigerator.



This symbol indicates that there are important operating and maintenance instructions in the literature accompanying your compact refrigerator.

WARNING

- 1 Read these instructions.
- 2 Keep these instructions.
- 3 Heed all warnings.
- 4 Follow all instructions.
- 5 Do not use this appliance near water.
- 6 Clean only with damp cloth.
- 7 Do not block any ventilation openings. Install in accordance with the manufacturer's instructions.
- 8 Do not install near any heat sources such as radiators, heat registers, stoves, or other apparatus (including amplifiers) that produce heat.
- 9 Do not defeat the safety purpose of the polarized or grounding-type plug. A polarized plug has two blades with one wider than the other. A grounding type plug has two blades and a third grounding prong. The wide blade or the third prong are provided for your safety. If the provided plug does not fit into your outlet, consult an electrician for replacement of the obsolete outlet.
- 10 Protect the power cord from being walked on or pinched particularly at plugs, convenience receptacles, and the point where they exit from the appliance.
- 11 Do not attempt to modify or extend the power cord of this appliance.
- 12 Unplug this appliance during lightning storms or when it will not be used for long periods of time.
- 13 Make sure that the available AC power matches the voltage requirements of this appliance.

- 14 Do not handle the plug with wet hands. This could result in an electric shock.
- 15 Unplug the power cord by holding the plug, never by pulling the cord.
- 16 Do not turn the appliance on or off by plugging or unplugging the power cord.
- 17 Turn off the appliance before unplugging it.
- 18 Refer all servicing to qualified service personnel. Servicing is required when the appliance has been damaged in any way, such as the power-supply cord or plug is damaged, liquid has been spilled or objects have fallen into the appliance, the appliance has been exposed to rain or moisture, does not operate normally, or has been dropped.
- 19 To reduce the risk of fire or electric shock, do not expose this appliance to rain, moisture, dripping, or splashing, and no objects filled with liquids should be placed on top of it.



WARNING

Electric Shock Hazard

Failure to follow these instructions can result in electric shock, fire, or death.

- 1 **WARNING**—Keep ventilation openings in the appliance clear of obstruction.
- 2 **WARNING**—Do not touch the interior of the freezer compartment with wet hands. This could result in frost bite.
- 3 **WARNING**—Do not use mechanical devices or other means to accelerate the defrosting process, other than those recommended by the manufacturer.
- 4 **WARNING**—Do not damage the refrigerant tubing when handling, moving, or using the refrigerator.
- 5 **WARNING**—Do not use electrical appliances inside the food storage compartment of the refrigerator, unless they are of the type recommended by the manufacturer.
- 6 **WARNING—DANGER**—Never allow children to play with, operate, or crawl inside the refrigerator.
Risk of child entrapment. Before you throw away your old refrigerator or freezer:
 - 1) Take off the doors
 - 2) Leave the shelves in place so that children may not easily climb inside
- 7 Unplug the refrigerator before carrying out user maintenance on it.



- 8 This appliance can be used by children age 8 years and older and persons with reduced physical or mental capabilities or lack of experience and knowledge if they are given supervision or instruction concerning the use of the appliance in a safe way and understand the hazards involved. Children should not play with the appliance. Cleaning and maintenance should not be performed by children without supervision.
- 9 If a component part is damaged, it must be replaced by the manufacturer, its service agent, or similar qualified persons in order to avoid a hazard.
- 10 Please dispose of the refrigerator according to local regulations as it contains flammable gas and refrigerant.
- 11 Follow local regulations regarding disposal of the appliance due to flammable refrigerant and gas. All refrigeration products contain refrigerants, which under the guidelines of federal law must be removed before disposal. It is the consumer's responsibility to comply with federal and local regulations when disposing of this product.
- 12 This appliance is intended to be used in household and similar environments.
- 13 Do not store or use gasoline or any flammable liquids inside or in the vicinity of this refrigerator.
- 14 Do not use an extension cord with this appliance. If the power cord is too short, have a qualified electrician install an outlet near the appliance. Use of an extension cord can negatively affect the refrigerator's performance.

Grounding requirement

This appliance must be grounded. This appliance is equipped with a cord having a grounding wire with a grounding plug. The plug must be inserted into an outlet that is properly installed and grounded.

Improper use of the grounding plug can result in a risk of electric shock. Consult a qualified electrician or service person if the grounding instructions are not completely understood, or if doubt exists as to whether the appliance is properly grounded.

Features

Package contents

- 4.3 cubic foot compact refrigerator
- Ice cube tray
- Ice scoop
- *User Guide*

Main components

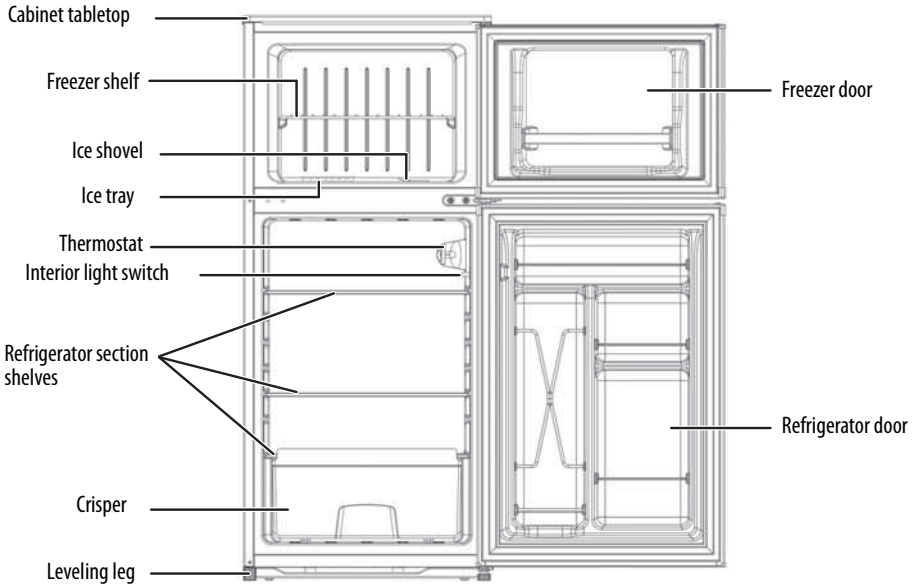

Setting up your refrigerator

Before using your refrigerator

- Remove the exterior and interior packing.
- Let the refrigerator stand upright for approximately four hours before connecting it to power. This reduces the possibility of a malfunction in the cooling system from improper handling during transportation.
- Clean the interior surface with lukewarm water using a soft cloth.

Finding a suitable location

- This refrigerator is designed to be free standing only, and should not be recessed or built-in.
- Place your refrigerator on a floor that is strong enough to support the refrigerator when it is fully loaded.
- Allow five inches of space between the back and sides of the refrigerator and any surrounding walls. This allows the proper air ventilation. Adjust the feet to keep the refrigerator level.

- Locate the refrigerator away from direct sunlight and sources of heat (stove, heater, radiator, and so on). Direct sunlight may affect the acrylic coating and heat sources may increase electrical consumption. Ambient temperature below 50°F (10°C) or above 85°F (29.4°C) will hinder the performance of this refrigerator. This refrigerator is not designed for use in a garage or any other outside installation.
- Avoid locating the refrigerator in moist areas.

Leveling your refrigerator

- It is very important for the refrigerator to be level in order to function properly. If the refrigerator is not leveled during installation, the doors may not close or seal properly, causing cooling, frost, or moisture problems.
- To level your refrigerator, you may either turn the leveling foot clockwise to raise that side to the refrigerator or turn it counter-clockwise to lower that side.

Note

Having someone push against the top of the refrigerator helps to take some weight off the leveling foot, making it easier to adjust.

Providing proper ventilation

Place the refrigerator at least five inches from the wall to ensure proper airflow to the compressor. Do not place the refrigerator near any heat sources, such as a heater or stove, as this may put a strain on the compressor.

Providing a proper power supply

Check your local power source. This refrigerator requires a 110V-120V, 60Hz power supply.

Use a receptacle that accepts the grounding prong. The power cord is equipped with a 3-prong (grounding) plug which mates with a standard 3-prong (grounding) wall outlet to minimize the possibility of electric shock hazard from this refrigerator.

Using a 3-prong plug and outlet

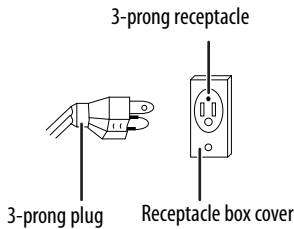

Using a grounding adapter

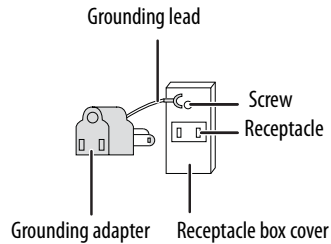

Notes

- The refrigerator should always be plugged into its own individual electrical outlet which has a voltage rating that matches the rating plate.
- Never unplug your refrigerator by pulling on the power cord. Always grip the plug firmly and pull straight out from the outlet.

Setting the thermostat

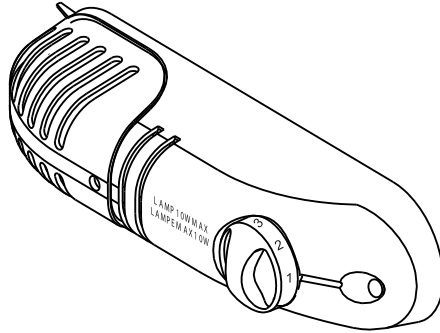

- 1 The first time you turn the refrigerator on, adjust the thermostat to “7” and run for at least two hours before putting food in.
- 2 After it is fully cooled, test it and adjust towards “4” to make less cool, to best suit your needs. The “4” setting should be appropriate for home or office refrigerator use.

Notes

- Turning the thermostat to the “0” position stops the cooling cycle but does not shut off the power to the refrigerator.
- If the refrigerator is unplugged or loses power, you must wait three to five minutes before restarting it. If you attempt to restart before this time delay, the refrigerator will not start.
- Large amounts of food will lower the cooling efficiency of the refrigerator.
- If you choose to change the thermostat setting, adjust it by one increment at a time. Allow several hours for temperature to stabilize between adjustments.

Using the freezer compartment

The freezer compartment is designed for the long-term storage of frozen foods.

The storage life of frozen foods varies and the recommended storage time should not be exceeded.

- Place frozen food into the freezer as quickly as possible after purchase. If there are instructions on the packet, carefully follow these instructions regarding storage times.

Making ice

- 1 Set the thermostat to "7".
- 2 Fill the ice cube tray (2/3 capacity) with cold water and place the tray on the bottom of the freezer compartment to freeze properly.
- 3 When the water in the ice cube tray has hardened, remove the ice tray from the freezer, then twist slightly to eject the ice cubes from the tray.
- 4 Re-set the thermostat to "4" when you are done making ice.

Defrosting your refrigerator

This refrigerator is not designed to defrost automatically. In order to prevent damage to the interior liner of the refrigerator from excessive frost build-up, defrost the refrigerator every three months or when ice or frost is approximately ¼" thick inside the freezer compartment.

- 1 Set the thermostat to "0", then remove all contents from the freezer compartment.
- 2 Leave the freezer door open to allow accumulated ice and frost to melt. Remove large pieces of ice as needed.

Caution

Do not use hot water or electric heating devices to melt the accumulated ice.

- 3 After defrosting, remove accumulated ice and water, then wipe the freezer compartment dry with a soft cloth.
- 4 Even though ice is not visibly present in the freezer compartment, allow the evaporator, located behind the freezer wall, to completely defrost for approximately two hours before restarting the refrigerator.
- 5 Restart following the instructions in "Setting the thermostat" on page 9.

Reversing the door position

Your refrigerator is built with a reversible door. Based on the location where you plan to use your compact refrigerator, you may find it more convenient to reverse the position of the door, to have it open from right to left instead of left to right.

Caution

To avoid injury to yourself or your property, we recommend that someone assist you during the door reversal process.

Reversing the door position

You will need: A 10 mm socket driver and a Phillips screw driver available.

- Make sure that your refrigerator is unplugged and empty.
- Have someone available to assist you in the process.
- Keep all of the parts you remove to reuse them later.
- Removing the door requires that the refrigerator be tilted backwards. Rest the refrigerator on something solid, such as a chair, just below the top panel.
- Do not lay the refrigerator completely flat so that you do not damage the coolant system.

Removing the door

- 1 Remove the decorative plugs from the top of the refrigerator, then remove the four screws (two on the top and two on the back) holding the top onto the refrigerator body.

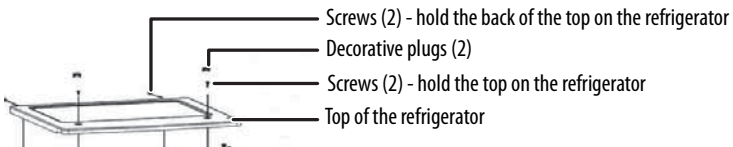

- 2 Remove the top of the refrigerator.
- 3 Remove the screws holding the top hinge to your refrigerator, then remove the hinge and the freezer door.

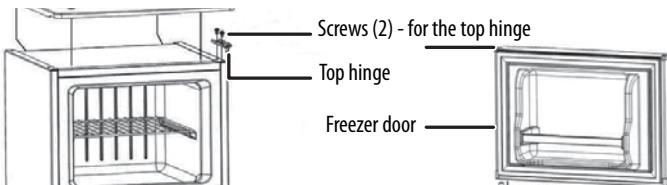

- 4 Remove the two screws holding the middle hinge to the refrigerator body, then remove the hinge.

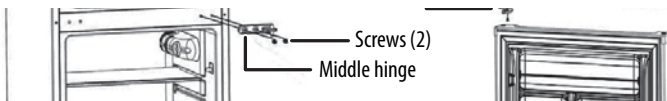

- 5 Pull the refrigerator door upwards and remove it from the refrigerator.
- 6 Tilt the refrigerator back or lay it on its back.
- 7 Unscrew the right and left leveling legs, then remove them.

- 8 Unscrew the screws holding the bottom hinge on the refrigerator and remove the hinge.

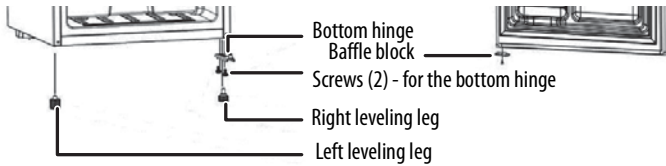

Reinstalling the doors

- 1 Reinstall the leveling leg you removed from the left side into the right bottom of your refrigerator and the leveling leg you removed from the right side into the left bottom of your refrigerator.
- 2 Install the bottom hinge on the left bottom of your refrigerator using the screws you previously removed. Tighten the screws.

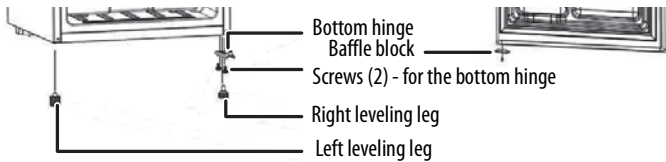

- 3 Align the hole in the bottom left of the refrigerator door with the bottom hinge pin, then install the door on the hinge pin.

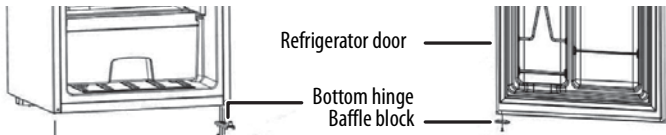

- 4 Place the middle hinge pin into the left top of the refrigerator door, then install the middle hinge on the left of the refrigerator with the screws your previously removed.

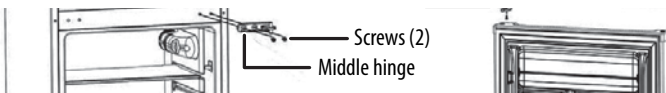

- 5 Check the fit and alignment (vertical and horizontal) of the door and make sure that it moves freely open and closed, then tighten the screws holding the middle hinge.

- 6 Align the hole in the bottom left of the freezer door with the top pin in the middle hinge, then install the freezer door on the hinge pin.

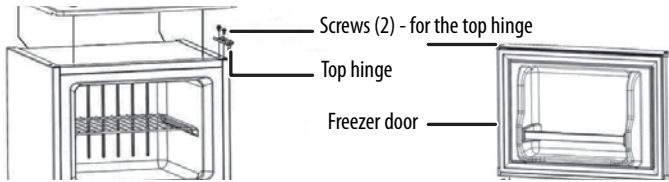

- 7 Install the top hinge on the left top of your refrigerator using the screws your previously removed.

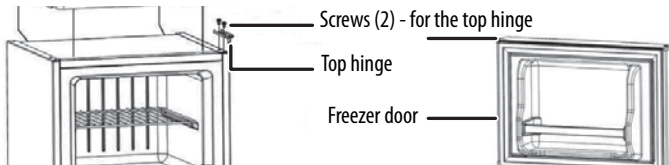

- 8 Check the fit and alignment (vertical and horizontal) of the freezer door and make sure it moves freely open and closed, then tighten the screws holding the top hinge.
- 9 Replace the top of the refrigerator.
- 10 Replace the four screws that hold the top of the refrigerator to the body of the refrigerator.
- 11 Install the screw covers previously removed into the holes in the top of the refrigerator.

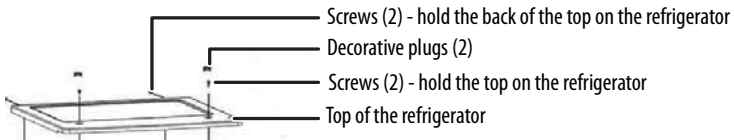

- 12 Adjust the leveling legs to level the refrigerator.

Maintaining your refrigerator

Your refrigerator is designed for year-round use with only minimal cleaning and maintenance.

When you first receive it, wipe the case with a mild detergent and warm water, then wipe dry with a dry cloth. Do this periodically to keep your refrigerator looking new.

Caution

To prevent damage to the finish, do not use:

- Gasoline, benzine, thinner, or other similar solvents.
- Abrasive cleaners.

Cleaning the interior of your refrigerator:

- 1 Turn off the refrigerator and unplug it from the wall outlet.
- 2 Remove all food.
- 3 Wash the inside with a damp warm cloth soaked in a solution of one quart of water lukewarm water to two tablespoons of baking soda solution.
- 4 Be sure to keep the door gasket (seal) clean to keep the refrigerator running efficiently.
- 5 Dry the interior and exterior with a soft cloth.

Changing the interior light

Caution

- All parts removed must be saved to reinstall the light bulb.
- Before removing the light bulb, unplug the refrigerator from the power supply. Failure to do so could result in electrical shock or personal injury.

- 1 Hold the lamp cover and push toward inside of the cabinet to remove it from the refrigerator compartment.
- 2 Unscrew the old bulb, then install the new bulb (10W/12E).
- 3 Re-install the lamp cover.

Shutting down your refrigerator - long vacations (several months)

- 1 Turn off the refrigerator and unplug it from the wall outlet.
- 2 Remove all food.
- 3 Clean the refrigerator.
- 4 Leave the door open slightly to avoid possible formation of condensation, mold, or odor.

Caution

Use extreme caution with children. The refrigerator should not be accessible to child's play.

Moving Your Refrigerator

- 1 Turn off the refrigerator and unplug it from the wall outlet.
- 2 Remove all food.
- 3 Securely tape down all loose items inside your refrigerator.
- 4 Tape the doors shut.
Be sure the refrigerator stays in the upright position during transportation.

Tips on saving energy

- Locate your refrigerator in the coolest area of the room, away from heat producing appliances or heating ducts and out of the direct sunlight.
- Let hot foods cool before placing them in the refrigerator. Overloading the refrigerator forces the compressor to run longer. Foods that freeze too slowly may lose quality or spoil.
- Wrap foods properly and wipe containers dry before placing them in the refrigerator. This cuts down on frost build-up inside the refrigerator.
- Organize and label food to reduce door openings and extended searches.

Troubleshooting

Caution

Do not try to repair your refrigerator yourself. Doing so invalidates the warranty.

Problem	Possible cause	Possible solution
The refrigerator does not operate	The refrigerator is unplugged.	Make sure that the refrigerator is plugged in and that the plug is pushed completely into the outlet.
	The thermostat is set to the "0" position.	Turn the thermostat knob to "4."
	The fuse on the circuit is blown or the circuit breaker is tripped.	Check the house fuse/circuit breaker box and replace the fuse or reset the circuit breaker.
	Power failure.	If a power failure occurs, the refrigerator turns off. Wait until the power is restored.
The compressor turns on and off frequently	The door has been opened too often or was not closed properly. The door seal may be dirty.	Make sure that the door is closed properly. Clean the door seal if necessary.
	The room temperature is hotter than normal.	This is normal, under the circumstances.
	A large amount of food was recently added to the refrigerator.	This is normal, under the circumstances.
	The thermostat is not set correctly.	Reset the thermostat correctly.
	The refrigerator does not have the correct clearances.	The refrigerator should be no closer than five inches from the adjacent walls.
	The refrigerator has recently been disconnected for a period of time.	Allow four hours for the refrigerator to cool down completely.
Food in the refrigerator compartment is freezing	The thermostat is set too cold.	Set the thermostat to a warmer setting.

Problem	Possible cause	Possible solution
Food in the refrigerator compartment is not cold	The door has been opened too often or was not closed properly.	Make sure that the door is closed properly.
	You have just added a large amount of food to the refrigerator or freezer compartments.	Allow time for the new food to cool, then check again.
	The thermostat is set too warm.	Adjust the thermostat to a colder setting.
	The door gasket does not seal properly.	Clean the gasket.
	The refrigerator has recently been disconnected for a period of time.	Allow four hours for the refrigerator to cool completely.
The refrigerator makes unusual noises.	The refrigerator may not be level on the floor.	Level the refrigerator with the leveling feet.
	The body of the refrigerator is touching a wall.	Move the refrigerator out from the wall.
Moisture is building up in the interior of the refrigerator	The door has been opened too often or was not closed properly.	Make sure that the door is closed properly.
	The refrigerator is in a location that is very humid.	Move the refrigerator to a dryer location.
	The food in the refrigerator is not packaged properly.	Repackage the food in the refrigerator to make sure that it is sealed.
The refrigerator door does not close completely	Food packages are interfering with the door.	Move the food packages or remove some food.
	The shelves are out of position.	Adjust the shelves properly.
	The door gaskets are dirty.	Clean the door gaskets.
	The refrigerator is not level.	Level the refrigerator with the leveling feet.
The exterior of the refrigerator is warm	This is normal.	
There is a popping or crackling sound when the compressor comes on	This is normal.	The sound should level off or disappear as the refrigerator continues to run.
There is a bubbling or gurgling sound, like water boiling	This is normal.	
Vibrations	The refrigerator is not on a level or sturdy surface.	Make sure that the refrigerator is on a level, sturdy surface. Level the refrigerator with the leveling legs.
	The refrigerator may be touching a wall.	Make sure that the refrigerator is not touching a wall.

Problem	Possible cause	Possible solution
There is moisture forming on the external walls of the refrigerator	The door may be slightly open.	Make sure that the door closes completely.

Specifications

Dimensions (WxDxH)	19.1 x 20.5 x 43.4 in (48.5 x 52.0 x 110.3 cm)
Weight	69.9 lbs (31.72 kg)
Power requirements	115 V~60 Hz - 110 W
Current	1.5 A
Power consumption (annual)	294 kwh

ONE-YEAR LIMITED WARRANTY - INSIGNIA

Definitions:

The Distributor* of Insignia branded products warrants to you, the original purchaser of this new Insignia-branded product ("Product"), that the Product shall be free of defects in the original manufacturer of the material or workmanship for a period of one (1) year from the date of your purchase of the Product ("Warranty Period").

For this warranty to apply, your Product must be purchased in the United States or Canada from a Best Buy branded or Future Shop branded retail store or online at www.bestbuy.com, www.bestbuy.ca, or www.futureshop.ca and is packaged with this warranty statement.

How long does the coverage last?

The Warranty Period lasts for 1 year (365 days) from the date you purchased the Product. Your purchase date is printed on the receipt you received with the Product.

What does this warranty cover?

During the Warranty Period, if the original manufacture of the material or workmanship of the Product is determined to be defective by an authorized Insignia repair center or store personnel, Insignia will (at its sole option): (1) repair the Product with new or rebuilt parts; or (2) replace the Product at no charge with new or rebuilt comparable products or parts. Products and parts replaced under this warranty become the property of Insignia and are not returned to you. If service of Products or parts are required after the Warranty Period expires, you must pay all labor and parts charges. This warranty lasts as long as you own your Insignia Product during the Warranty Period. Warranty coverage terminates if you sell or otherwise transfer the Product.

How to obtain warranty service?

If you purchased the Product at a Best Buy or Future Shop retail store location, please take your original receipt and the Product to any Best Buy or Future Shop store. Make sure that you place the Product in its original packaging or packaging that provides the same amount of protection as the original packaging. If you purchased the Product from a Best Buy or Future Shop online web site (www.bestbuy.com, www.bestbuy.ca, or www.futureshop.ca), mail your original receipt and the Product to the address listed on the web site. Make sure that you put the Product in its original packaging or packaging that provides the same amount of protection as the original packaging.

To obtain warranty service, in the United States call 1-888-BESTBUY, Canada call 1-866-BESTBUY for Future Shop call 1-800-663-2275. Call agents may diagnose and correct the issue over the phone.

Where is the warranty valid?

This warranty is valid only in the United States and Canada at Best Buy or Future Shop branded retail stores or websites to the original purchaser of the product in the county where the original purchase was made.

What does the warranty not cover?

This warranty does not cover:

- Food loss/spoilage due to failure of refrigerator or freezer
- Customer instruction/education
- Installation
- Set up adjustments
- Cosmetic damage
- Damage due to weather, lightning, and other acts of God, such as power surges
- Accidental damage
- Misuse
- Abuse
- Negligence

- Commercial purposes/use, including but not limited to use in a place of business or in communal areas of a multiple dwelling condominium or apartment complex, or otherwise used in a place of other than a private home.
- Modification of any part of the Product, including the antenna
- Display panel damaged by static (non-moving) images applied for lengthy periods (burn-in).
- Damage due to incorrect operation or maintenance
- Connection to an incorrect voltage or power supply
- Attempted repair by any person not authorized by Insignia to service the Product
- Products sold “as is” or “with all faults”
- Consumables, including but not limited to batteries (i.e. AA, AAA, C etc.)
- Products where the factory applied serial number has been altered or removed
- Loss or Theft of this product or any part of the product
- Display panels containing up to three (3) pixel failures (dots that are dark or incorrectly illuminated) grouped in an area smaller than one tenth (1/10) of the display size or up to five (5) pixel failures throughout the display. (Pixel based displays may contain a limited number of pixels that may not function normally.)
- Failures or Damage caused by any contact including but not limited to liquids, gels or pastes.

REPAIR REPLACEMENT AS PROVIDED UNDER THIS WARRANTY IS YOUR EXCLUSIVE REMEDY FOR BREACH OF WARRANTY. INSIGNIA SHALL NOT BE LIABLE FOR ANY INCIDENTAL OR CONSEQUENTIAL DAMAGES FOR THE BREACH OF ANY EXPRESS OR IMPLIED WARRANTY ON THIS PRODUCT, INCLUDING, BUT NOT LIMITED TO, LOST DATA, LOSS OF USE OF YOUR PRODUCT, LOST BUSINESS OR LOST PROFITS. INSIGNIA PRODUCTS MAKES NO OTHER EXPRESS WARRANTIES WITH RESPECT TO THE PRODUCT, ALL EXPRESS AND IMPLIED WARRANTIES FOR THE PRODUCT, INCLUDING, BUT NOT LIMITED TO, ANY IMPLIED WARRANTIES OF AND CONDITIONS OF MERCHANTABILITY AND FITNESS FOR A PARTICULAR PURPOSE, ARE LIMITED IN DURATION TO THE WARRANTY PERIOD SET FORTH ABOVE AND NO WARRANTIES, WHETHER EXPRESS OR IMPLIED, WILL APPLY AFTER THE WARRANTY PERIOD. SOME STATES, PROVINCES AND JURISDICTIONS DO NOT ALLOW LIMITATIONS ON HOW LONG AN IMPLIED WARRANTY LASTS, SO THE ABOVE LIMITATION MAY NOT APPLY TO YOU. THIS WARRANTY GIVES YOU SPECIFIC LEGAL RIGHTS, AND YOU MAY ALSO HAVE OTHER RIGHTS, WHICH VARY FROM STATE TO STATE OR PROVINCE TO PROVINCE.

Contact Insignia:

For customer service please call 1-877-467-4289

www.insigniaproducts.com

INSIGNIA is a trademark of Best Buy and its affiliated companies.

Registered in some countries.

Distributed by Best Buy Purchasing, LLC

7601 Penn Ave South, Richfield, MN 55423 U.S.A.

©2015 Best Buy. All rights reserved.

Made in China

INSIGNIA™

www.insigniaproducts.com

1-877-467-4289 (U.S. and Canada) or 01-800-926-3000 (Mexico)

INSIGNIA is a trademark of Best Buy and its affiliated companies.

Registered in some countries.

Distributed by Best Buy Purchasing, LLC

7601 Penn Ave South, Richfield, MN 55423 U.S.A.

©2015 Best Buy. All rights reserved.

Made in China.

V1 ENGLISH
15-0265