



# RAZER KIYO PRO

MASTER GUIDE

Achieve the highest standards of streaming with the **Razer Kiyo Pro**—a USB webcam with a high-performance adaptive light sensor for max fidelity at 1080p 60FPS, and the ability to enable HDR at 30FPS. Give your viewers the pro-grade clarity and quality they deserve in any setup and lighting condition.

# CONTENTS

1. WHAT'S INSIDE / WHAT'S NEEDED.....	3
2. LET'S GET YOU COVERED.....	5
3. TECHNICAL SPECIFICATIONS.....	6
4. GETTING STARTED.....	7
5. CONFIGURING YOUR RAZER KIYO PRO VIA RAZER SYNAPSE.....	8
6. SAFETY AND MAINTENANCE.....	16
7. LEGALESE.....	17

---

## 1. WHAT'S INSIDE / WHAT'S NEEDED

### WHAT'S INSIDE

- Razer Kiyo Pro

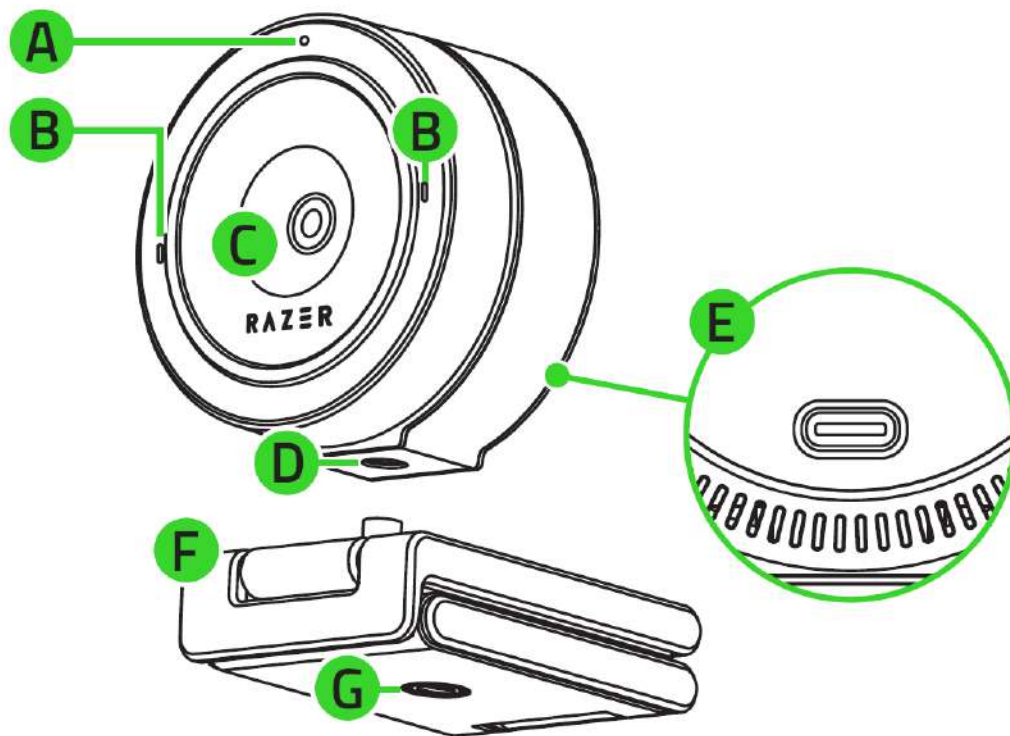

- |   |                        |
|---|------------------------|
| A. Status indicator                                     | D. Camera thread mount |
| B. Built-in microphones                                 | E. Power port          |
| C. Wide-angle lens with adjustable Field of View (FoV)* | F. Detachable stand    |
|   | G. Stand thread mount  |

*\*Field of View adjustment can be made using Razer Synapse.*

- Type A to Type C cable

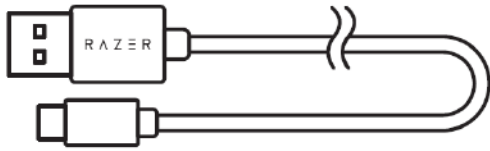

- Lens cover

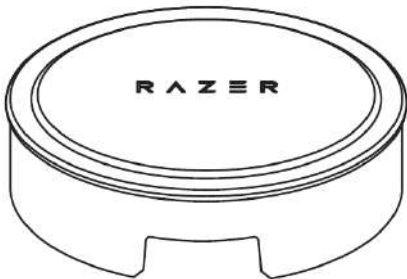

- Important Product Information Guide

## WHAT'S NEEDED

### PRODUCT REQUIREMENTS

- Direct USB connection to a PC\*

### RAZER SYNAPSE REQUIREMENTS

- Windows® 8 64-bit (or higher)\*
- Internet connection for software installation

*\*Windows® 10 and USB 3.0 is recommended to maximize streaming and/or recording performance.*

---

## 2. LET'S GET YOU COVERED

You've got a great device in your hands, complete with a 1-year limited warranty coverage. Now maximize its potential and score exclusive Razer benefits by registering at [razerid.razer.com](https://razerid.razer.com)

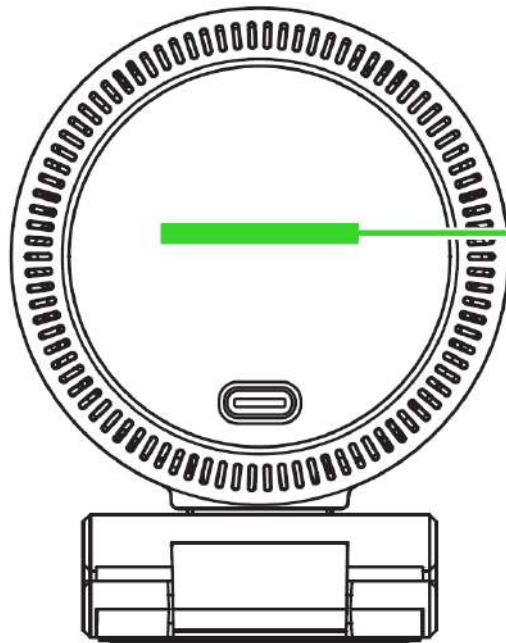

*Your product's  
serial number can  
be found here.*

Got a question? Ask the Razer Support Team at [support.razer.com](https://support.razer.com)

---

## 3. TECHNICAL SPECIFICATIONS

### CAMERA

- Connection type: USB3.0
- Image resolution: 2.1 Megapixels
- Video Resolution: 1080p @ 60/30/24FPS / 720p @ 60FPS / 480p @ 30FPS / 360p @ 30FPS
- Video encoding: H.264 codec
- Still Image Resolution: 1920x1080
- Image Quality Settings Customization: Yes
- Diagonal Field of View (FOV): 103°, 90°, 80°
- Focus Type: Auto
- Mounting Options: L-shape joint and Tripod (Not included)
- Cable Length: 1.5 meters braided cable

### MICROPHONE

- Channels: Stereo
- Audio Codec: 16bit 48KHz
- Polar patterns: Omni-directional
- Sensitivity: -38dB

---

## 4. GETTING STARTED

1. Depending on your setup, you may either position the camera on top of a monitor or table; or attach the camera to a tripod\* using the stand's thread mount.

**i** You may also detach the stand if you want to affix the camera directly to a tripod\*.

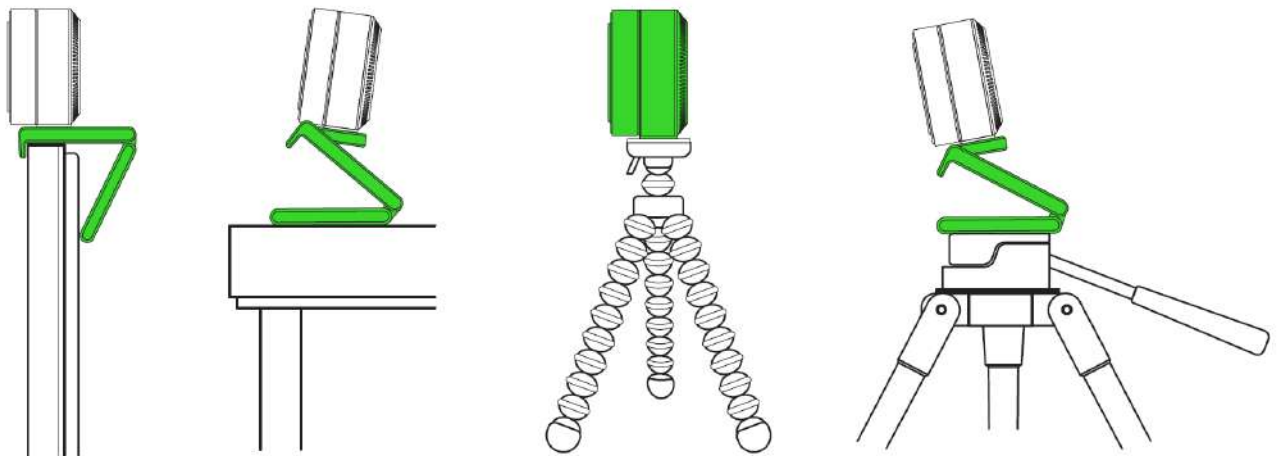

\*Tripod not included.

2. Connect the camera to a USB port on your PC using the Type A to Type C cable and launch any camera application. The camera's status indicator will light up, indicating that the device is active.

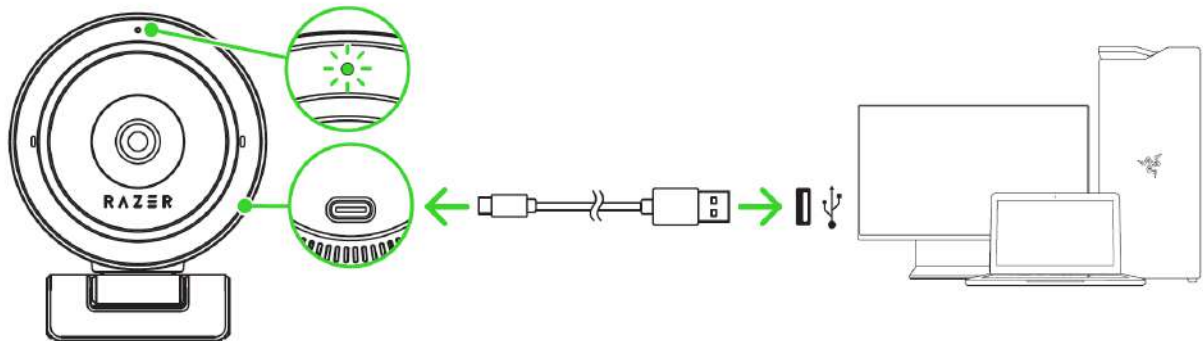

**i** To optimize the streaming and recording performance of your camera, it's highly recommended that you connect it directly to a USB 3.0 port on your PC. Connecting the device to a USB 2.0 port, USB hub, switch or extender may affect its performance.

3. Use the Razer Synapse to customize various settings such as your camera's pan, zoom, image and audio quality, and more.

\*Install Razer Synapse when prompted or download its installer from [razer.com/synapse](https://www.razer.com/synapse)



---

## 5. CONFIGURING YOUR RAZER KIYO PRO VIA RAZER SYNAPSE

- i** *Internet connection is required for installation, updates and cloud-based features. Registering for a Razer ID account is recommended, but optional. All listed features are subject to change based on the current software version, connected device(s), and supported apps and software.*

### SYNAPSE TAB

The Synapse tab is your default tab when you first launch Razer Synapse. This tab allows you to navigate the Dashboard subtab.

### Dashboard

The Dashboard subtab is an overview of your Razer Synapse where you can access all your Razer devices, modules, and online services.

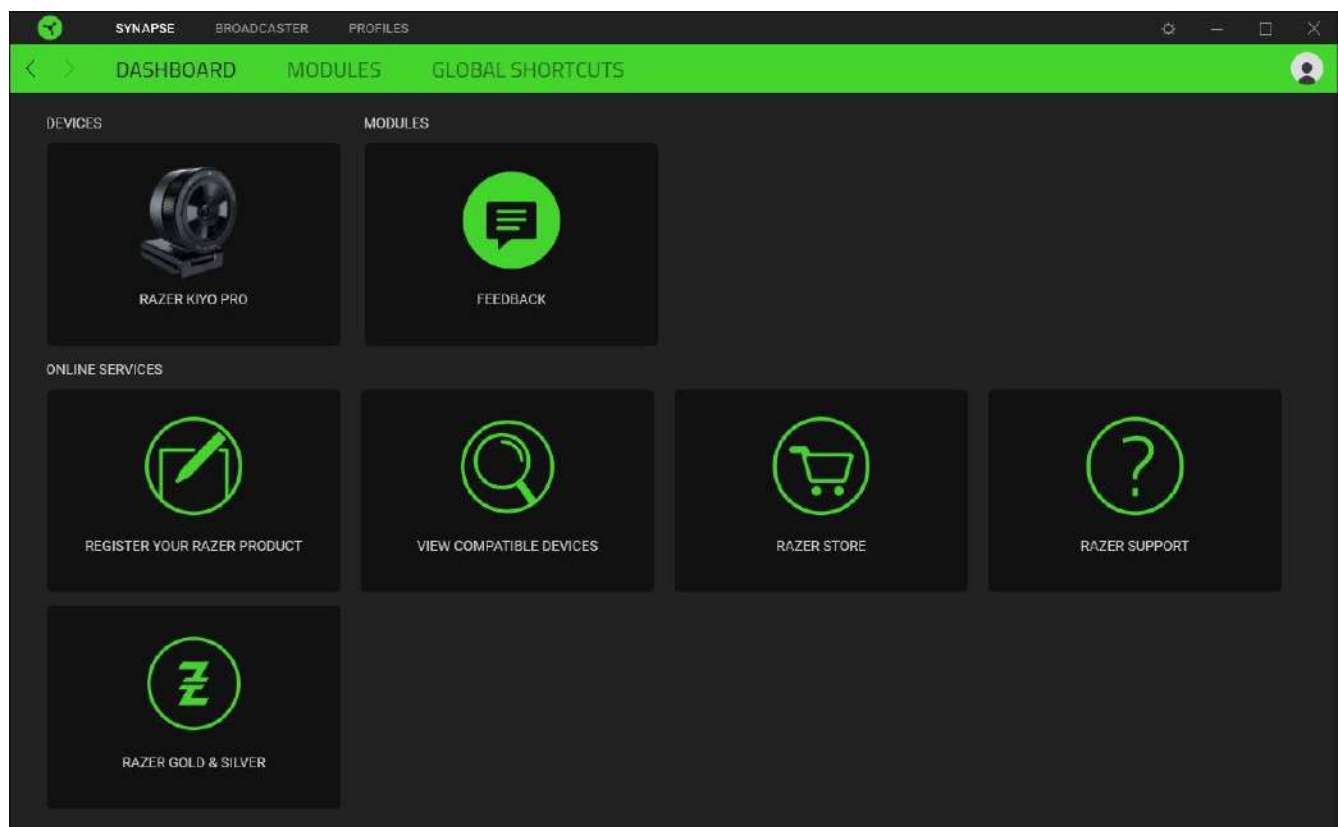

## Modules

The Modules subtab displays all installed and available modules for installation.

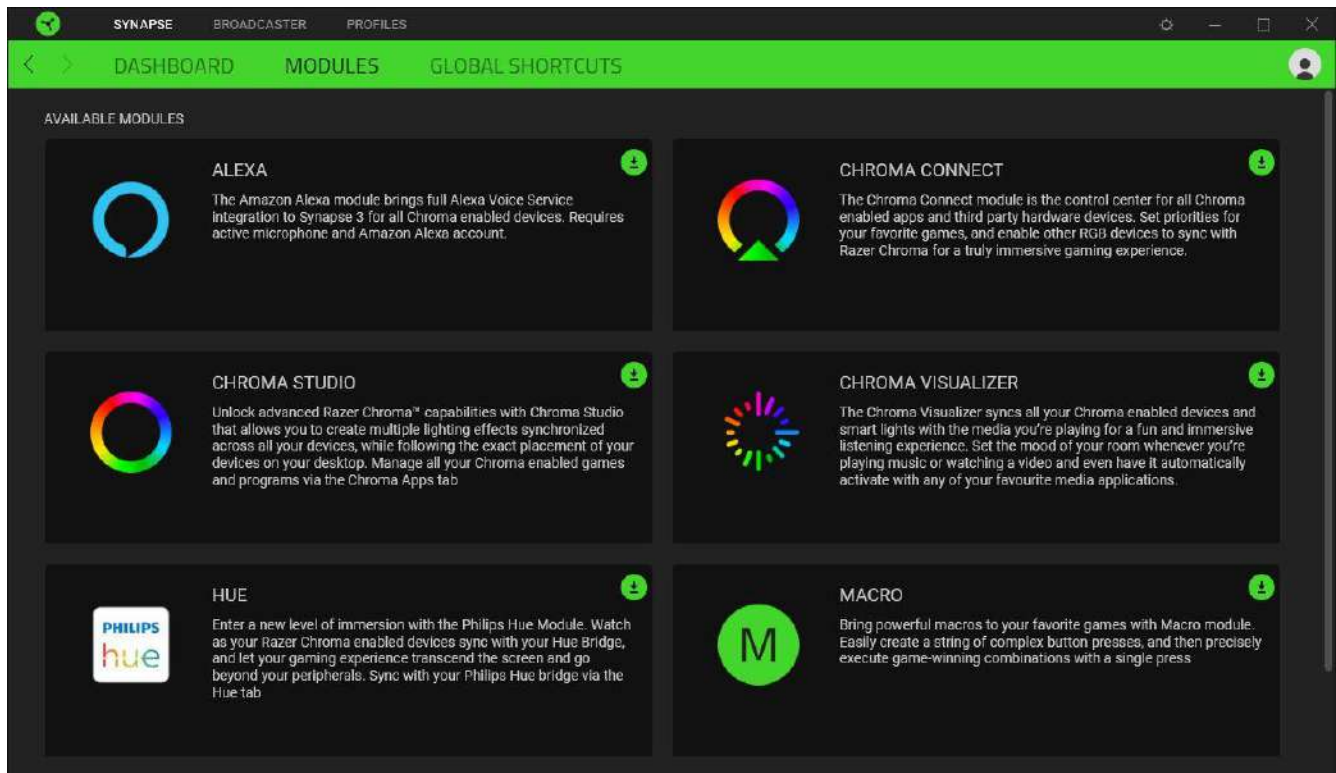

## Global Shortcuts

Bind operations or Razer Synapse functions to custom key-combinations from any Razer Synapse-enabled device inputs which apply across all device profiles. [Learn more about Profiles](#)

 *Only Razer Synapse-enabled device inputs will be recognized.*

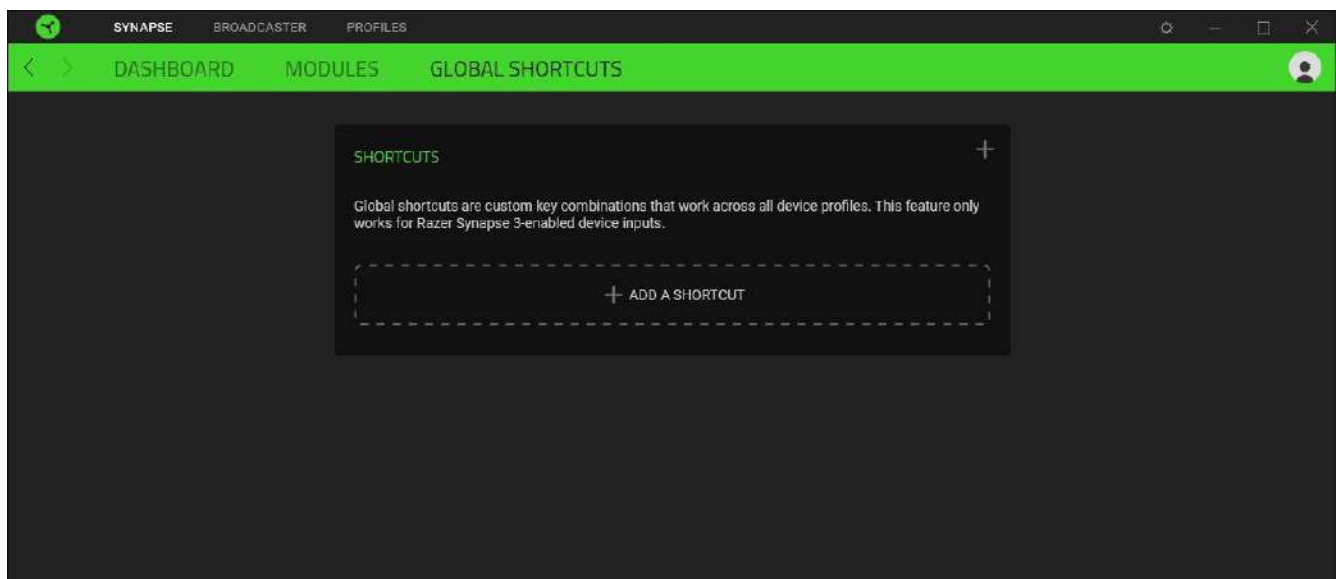

## BROADCASTER TAB

The Broadcaster tab is the main tab for your Razer Kiyo Pro. From here, you'll be able to view and customize your camera feed's preview. Changes made under this tab are automatically saved to your system and cloud storage.

### Settings

The Settings subtab enables you to see your camera's real time preview as you customize its settings such as enabling HDR capture, changing the camera's focus and Field of View (FoV) properties, and adjusting other image settings.

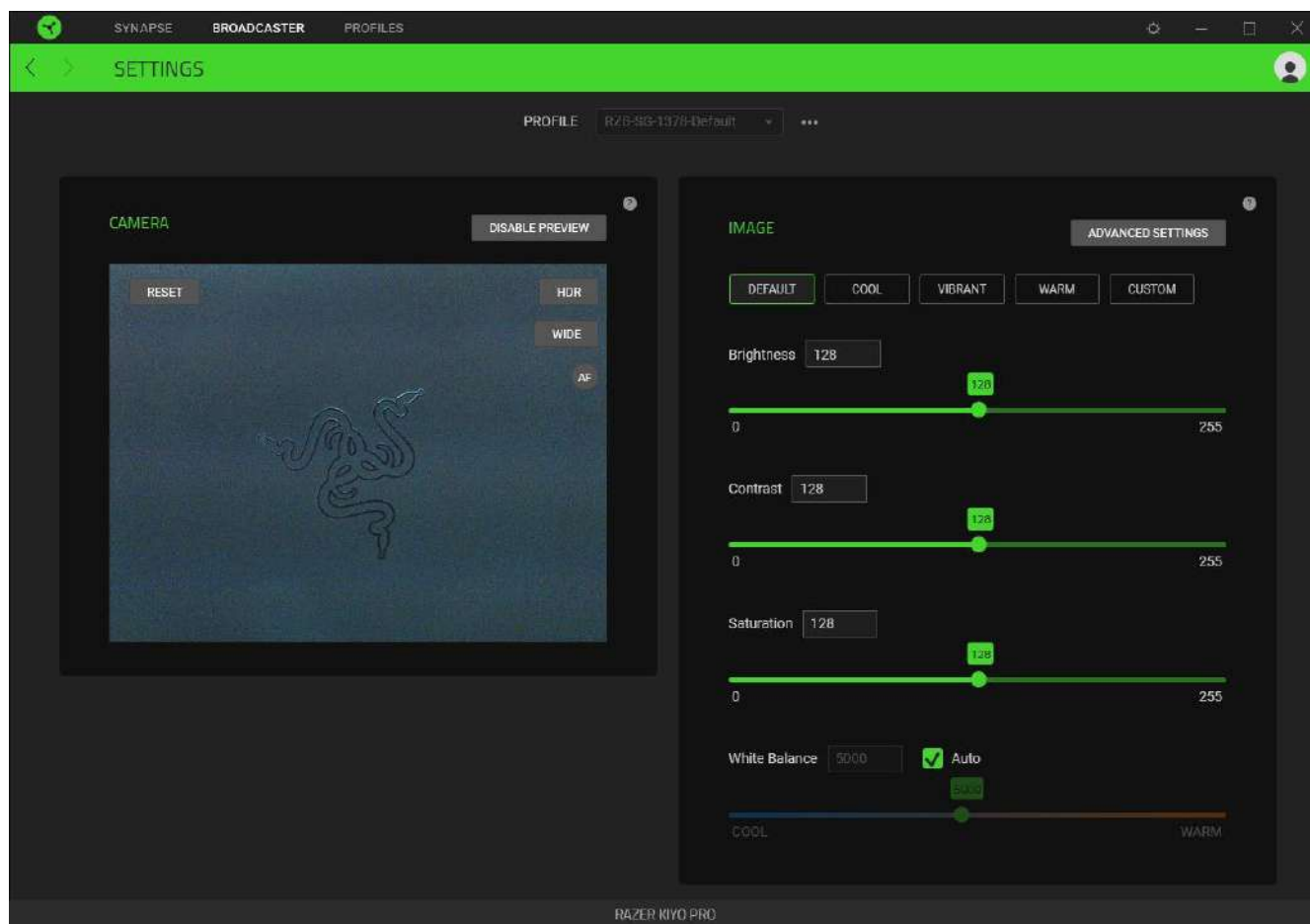

### Profile

A Profile is a data storage for keeping all your Razer devices' settings. By default, the profile name is based on your system's name. To add, import, rename, duplicate, export, or delete a profile, simply press the profile's corresponding Miscellaneous button ( ●●● ).

## Camera

Displays the camera's real time preview. Here you'll also be able to modify the following:

- **Disable Preview.** Disable the camera preview. This is useful if you want other applications to begin using your Razer Kiyo Pro.
  - ❗ *When the camera preview is disabled, all camera settings will become unchangeable.*
- **Dynamic Range.** Enable or disable High Dynamic Range (HDR).
- **Field of View (FoV).** Change how much area is captured by the camera. Simply click to switch between Wide, Medium, and Narrow field of view.
- **Automatic Focus (AF) / Manual Focus (MF).** Switch between Automatic and Manual focus. When Manual Focus is active, you'll be able to manually adjust the camera's focus through the focus slider.
- **Reset.** Resets all camera settings to their default properties.

## Image

Fine tune the camera's image settings using any of the available image presets or by adjusting each setting's corresponding slider as preferred.

- **Brightness.** Control the overall brightness of the camera preview.
- **Contrast.** Highlight the separation of tones within the camera's preview.
- **Saturation.** Change the intensity of the camera preview's color.
- **White Balance.** Control the color temperature of the camera's light source.

Alternatively, you may also click on **Advanced Settings** to open your operating system's camera properties window and individually customize color corrections and camera controls.

- ❗ *Razer Synapse will prompt you to select which setting you want to keep when making changes on the Advanced Settings or other camera apps. To keep changes made from the Advanced Settings or other camera apps, make sure to select 'Camera' when prompted.*



## PROFILES TAB

The Profiles tab is a convenient way of managing all your profiles and linking them to your games and applications.

### Devices

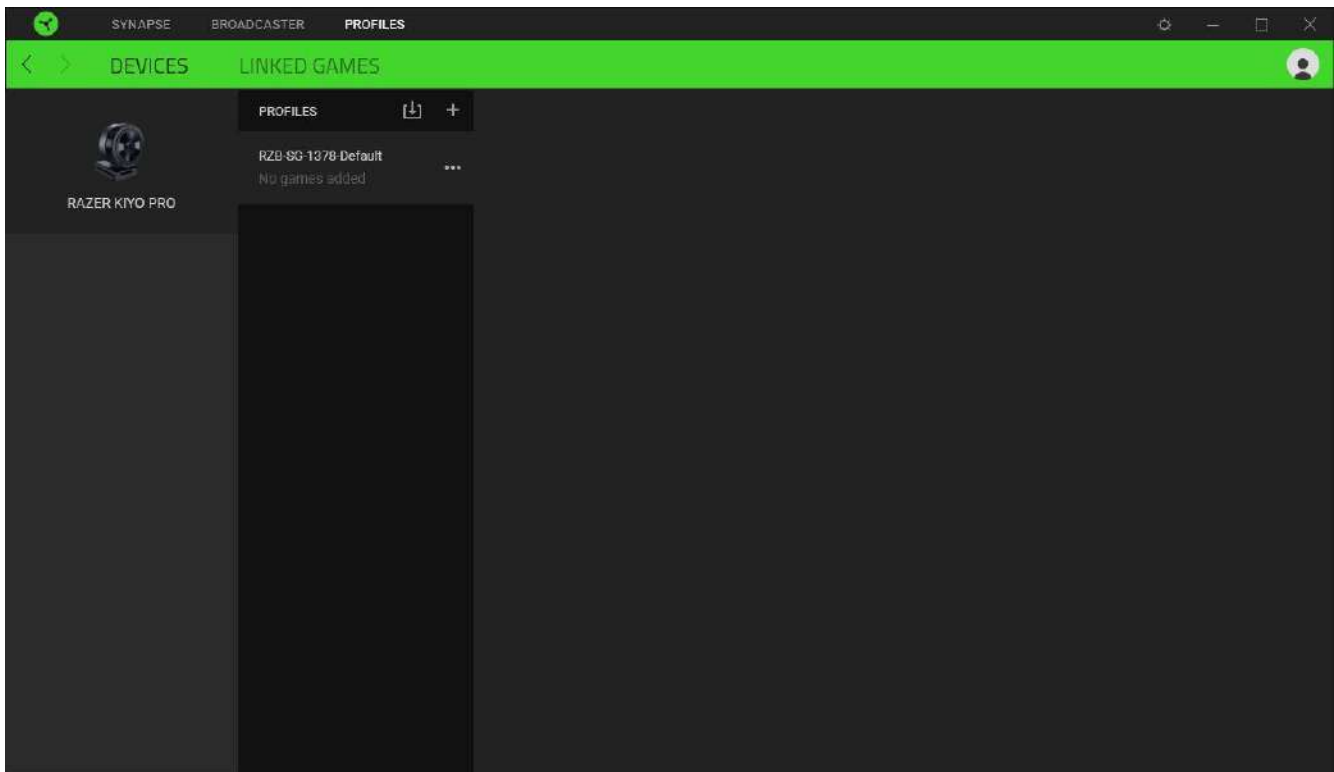
View which games are linked to each device's profiles or which Chroma Effect is linked to specific games using the Devices subtab.



You can import Profiles from your computer or from the cloud through the import button (  ) or create new profiles within the selected device using the add button (  ). To rename, duplicate, export, or delete a profile, simply press the Miscellaneous button (  ). Each profile can be set to automatically activate when you run an application using the Linked Games option.

## Linked Games

The Linked Games subtab gives you the flexibility to add games, view devices that are linked to games, or search for added games. You can also sort games based on alphabetical order, last played, or most played. Added games will still be listed here even if it is not linked to a Razer device.

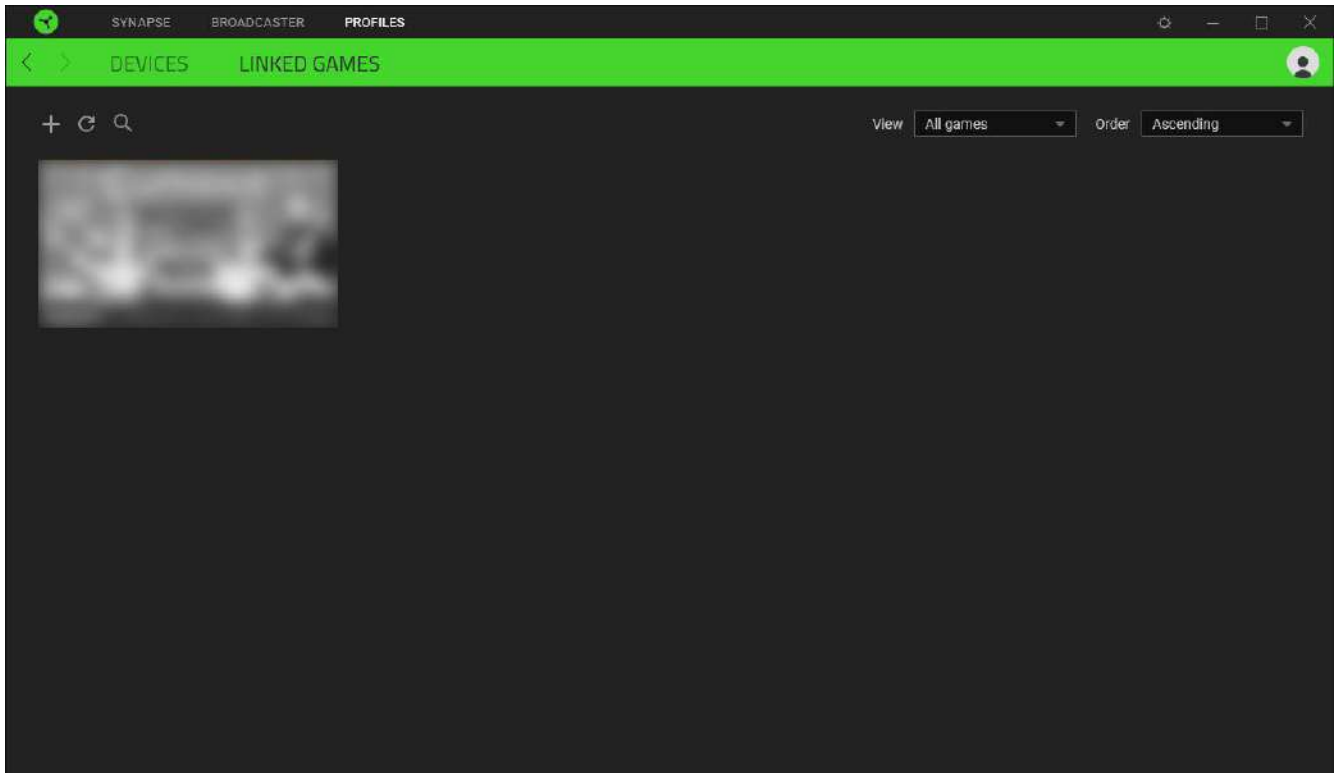

To link games to connected Razer devices or Chroma Effects, simply click on any game from the list, and then click **Select a device and its profile to launch automatically during gameplay** to select the Razer device or Chroma Effect it will link with. Once linked, you may click on the Miscellaneous button (●●●) of the corresponding Chroma Effect or device to select a specific Chroma Effect or profile.

## SETTINGS WINDOW

The Settings window, accessible by clicking the ( ⚙ ) button on Razer Synapse, enables you to configure the startup behavior and display language of Razer Synapse, view the master guides of each connected Razer device, or perform factory reset on any connected Razer device.

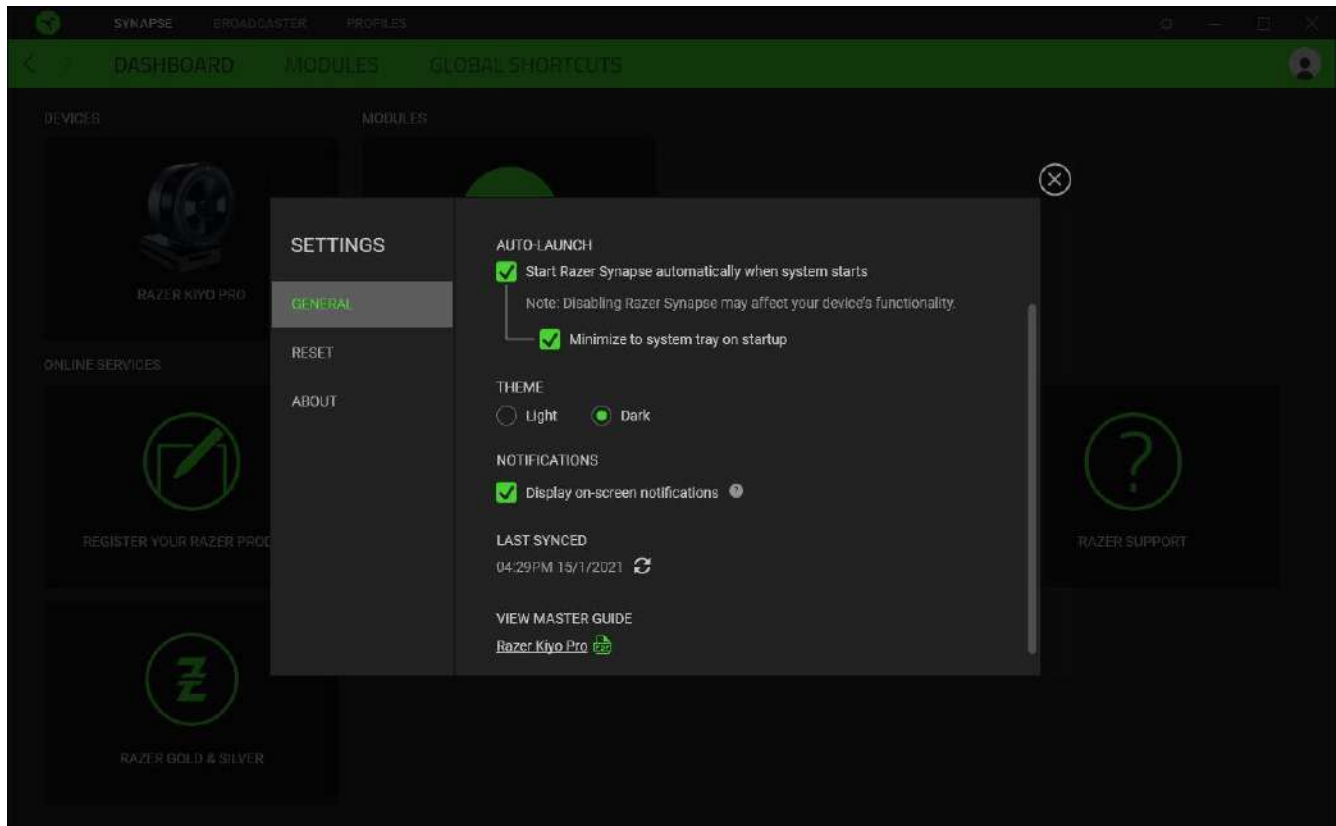

### General tab

The default tab of the Settings window. The General tab enables you to change the software's display language, start-up behavior, display theme, and on-screen notifications display. You may also manually sync your profiles to the cloud ( ↻ ) or view the master guide of all connected Razer devices and installed modules.

### Reset tab

The Reset tab allows you to perform a factory reset on all connected Razer devices with on-board memory and/or reset Razer Synapse tutorials to acquaint yourself again with Razer Synapse's new features on its next launch.



*By resetting a Razer device, all profiles stored on the selected device's on-board memory will be erased.*

**About tab**

The About tab displays brief software information, copyright statement and provides relevant links for its terms of use. You may also use this tab to check for software updates, or as a quick access to Razer's social communities.



---

## 6. SAFETY AND MAINTENANCE

### SAFETY GUIDELINES

In order to achieve maximum safety while using your Razer Kiyo Pro, we suggest that you adopt the following guidelines:

Should you have trouble operating the device properly and troubleshooting does not work, unplug the device and contact the Razer hotline or go to [support.razer.com](https://support.razer.com) for support.

Do not take apart the device and do not attempt to operate it under abnormal current loads. Doing so will void your warranty.

Do not use or install the device and its components near water, moisture, solvents, or other wet surfaces, nor expose the device to high temperatures or direct sunlight for an extended period of time.

Keep the device away from liquid, humidity or moisture. Operate the device only within the specific temperature range of 0°C (32°F) to 40°C (104°F). Should the temperature exceed this range, unplug and/or switch off the device in order to let the temperature stabilize to an optimal level.

### MAINTENANCE AND USE

The Razer Kiyo Pro requires minimum maintenance to keep it in optimum condition. Once a month we recommend you unplug the device from the computer and clean it using a soft cloth or cotton to prevent dirt buildup. Do not use soap, harsh cleaning agents, or abrasives.

---

## 7. LEGALESE

### **COPYRIGHT AND INTELLECTUAL PROPERTY INFORMATION**

©2021 Razer Inc. All rights reserved. Razer, the triple-headed snake logo, Razer logo, “For Gamers. By Gamers.”, and “Powered by Razer Chroma” logo are trademarks or registered trademarks of Razer Inc. and/or affiliated companies in the United States or other countries. All other trademarks are the property of their respective owners.

Windows and the Windows logo are trademarks of the Microsoft group of companies.

Razer Inc. (“Razer”) may have copyright, trademarks, trade secrets, patents, patent applications, or other intellectual property rights (whether registered or unregistered) concerning the product in this guide. Furnishing of this guide does not give you a license to any such copyright, trademark, patent or other intellectual property right. The Razer Kiyo Pro (the “Product”) may differ from pictures whether on packaging or otherwise. Razer assumes no responsibility for such differences or for any errors that may appear. Information contained herein is subject to change without notice.

### **LIMITED PRODUCT WARRANTY**

For the latest and current terms of the Limited Product Warranty, please visit [razer.com/warranty](https://www.razer.com/warranty).

### **LIMITATION OF LIABILITY**

Razer shall in no event be liable for any lost profits, loss of information or data, special, incidental, indirect, punitive or consequential or incidental damages, arising in any way out of distribution of, sale of, resale of, use of, or inability to use the Product. In no event shall Razer’s liability exceed the retail purchase price of the Product.

### **GENERAL**

These terms shall be governed by and construed under the laws of the jurisdiction in which the Product was purchased. If any term herein is held to be invalid or unenforceable, then such term (in so far as it is invalid or unenforceable) shall be given no effect and deemed to be excluded without invalidating any of the remaining terms. Razer reserves the right to amend any term at any time without notice.