



Voyager 4300 UC Series

Bluetooth headset

User guide

Contents

Headset overview	3
Be safe	3
USB Bluetooth adapter	3
Charge stand (select models only)	4
Connect and pair	5
Connect to PC	5
Configure USB adapter	5
Pair to mobile device	5
Pair USB adapter again	6
Pair mode	6
Fit and charge	7
Wear on the right or left	7
Charge	7
Check headset battery status	7
Load software	9
Update your Poly device	9
The basics	10
Power on/off	10
Adjust the volume	10
Adjust voice prompt volume	10
Make/Take/End Calls	10
Launch Microsoft Teams (Teams model only)	11
Play or pause audio	11
Voice assistant	11
More Features	12
Select language	12
DeepSleep Mode	12
Online indicator	12
Corded mode (audio over USB)	12
Troubleshooting	13
What's in the box	15
Support	16

Headset overview

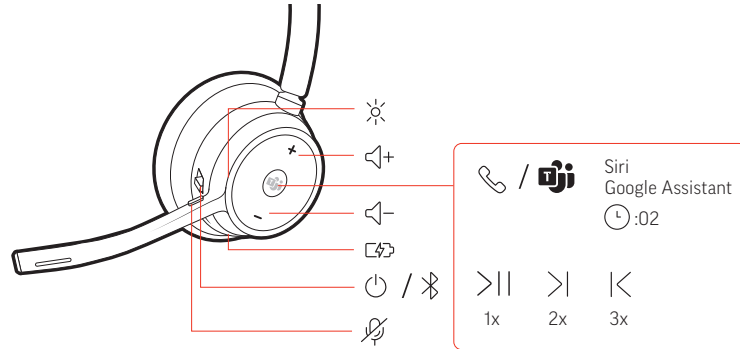

	LEDs/Online indicator
	Volume up
	Call button/Press to interact with Microsoft Teams (app required)
Siri®, Google Assistant™	Smartphone feature: Default voice assistant
	Play/pause**
	Next track**
	Previous track**
	Volume down
	Charge port
	Power
	Bluetooth® pairing
	Mute/unmute

NOTE **Functionality varies by application. May not function with web-based apps.

Be safe

Please read the safety guide for important safety, charging, battery and regulatory information before using your new headset.

USB Bluetooth adapter

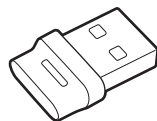

Your high-fidelity Bluetooth USB adapter comes pre-paired to your Poly device. Plug it into your computer to connect to computer audio.

NOTE Adapter design may vary

Standard LEDs

USB LEDs	What they mean
Flashing red and blue	Pairing
Solid blue	Headset connected
Flashing blue	On a call
Solid red	Mute active
Flashing purple	Streaming media from computer

LEDs when Microsoft Teams* is detected

USB LEDs	What they mean
Flashing red and blue	Pairing
Solid purple	Microsoft Teams connected
Flashing blue	On a call
Solid red	Mute active
Pulsing purple	Microsoft Teams notification

NOTE *Requires Microsoft Teams desktop application

Charge stand (select models only)

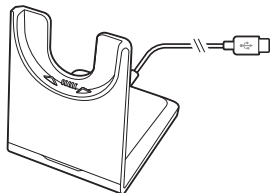

NOTE The charge stand plugs into a computer or wall charger's USB port.

Connect and pair

Connect to PC

Your Bluetooth USB adapter comes pre-paired to your headset.

- 1 Turn on your headset and insert the Bluetooth USB adapter into your laptop or PC.

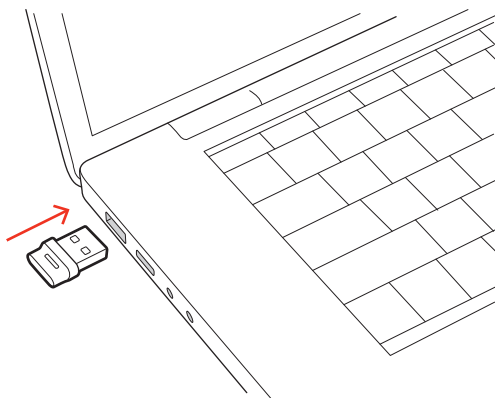

- 2 The USB adapter LED flashes and then turns solid to indicate the headset is connected to the USB adapter. If you are wearing your headset you hear "PC connected" to indicate the connection has been established. When on a call, the LED on the USB adapter flashes blue. When not on a call the LED is solid.
- 3 Load Poly Lens Desktop App by visiting poly.com/lens. This allows you to customize your headset behavior through advanced settings and options.

Configure USB adapter

Your high-fidelity Bluetooth USB adapter comes ready to take calls. If you want to listen to music, you will need to configure your Bluetooth USB adapter.

Windows

- 1 To configure your Bluetooth USB adapter to play music, go to Start menu > Control Panel > Sound > Playback tab. Select **Poly BT700** or **Plantronics BT600**, set it as the Default Device and click OK.
- 2 To pause music when you place or receive calls, go to Start menu > Control Panel > Sound > Communications tab and select the desired parameter.

Mac

- 1 To configure the Bluetooth USB adapter, go to Apple menu > System Preferences > Sound. On both the Input and Output tabs, select **Poly BT700** or **Plantronics BT600**.

Pair to mobile device

- 1 To put your headset in pair mode, slide and hold the Power $\text{\textcircled{P}}$ switch away from the off position until you hear "pairing" and the headset LEDs flash red and blue.



- 2 Activate Bluetooth on your phone and set it to search for new devices.

- iPhone Settings > Bluetooth > On*
- Android Settings > Bluetooth On > Scan for devices*

NOTE *Menus may vary by device.

- 3 Select "Poly V43XX Series."
Once successfully paired, you hear "pairing successful" and the headset LEDs stop flashing.
NOTE Your headset can pair with up to 8 devices but only maintain 2 connections simultaneously; this includes the Bluetooth adapter.

Pair USB adapter again

Typically, your USB adapter is pre-paired to your headset. In the event that your adapter is disconnected or bought separately, you will need to pair the adapter to your headset.

- 1 Insert the high-fidelity Bluetooth USB adapter into your laptop or computer and wait for your computer to recognize it.
- 2 Put your headset in pair mode.
- 3 Put your Bluetooth USB adapter into pair mode by selecting "Pair" in Poly Lens App. Your adapter flashes red and blue.
Pairing is successful when you hear "pairing successful" and "PC connected" and the Bluetooth USB adapter LED is solid.

Pair mode

Slide and hold the headset Power  switch away from the off position until the LEDs flash red and blue.

Fit and charge

Wear on the right or left

To position the microphone on the right or left side, rotate the microphone boom up and over. Gently bend the boom so it is approximately 2 finger widths from the corner of your mouth.

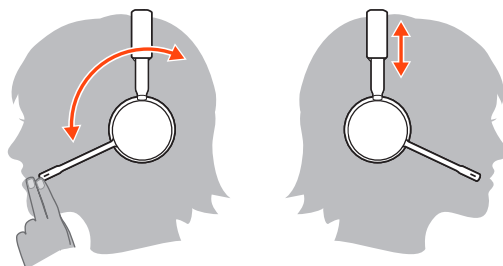

Charge

Charge your headset using the USB cable or the charge stand (select models only). The headset LEDs flash when charging. It takes approximately 90 minutes to fully charge your headset. The LEDs turn off once charging is complete.

NOTE The USB cable and charge stand (select models only) plug into a computer or wall charger's USB port.



USB cable

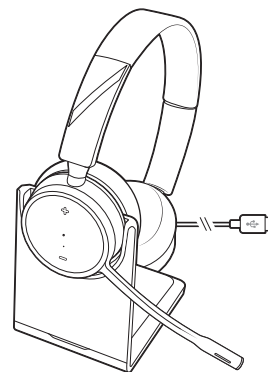

Charge stand (select models only)

Headset LEDs	What they mean
Off	Charging complete
●●●	Battery high
●●	Battery medium
●	Battery low
☠	Battery critical

Check headset battery status

Check your headset battery status:

- View status in Poly Lens Desktop App
- With headset inactive, slide and release the Power  switch away from the off position. Listen to the voice alert or observe the headset LEDs.

Headset LED behavior while charging

Off Charging complete

● ● ● Battery high

● ● Battery medium

● Battery low

✖ Battery critical

TIP *To reset the accuracy of the talk time alert, deplete the headset battery then charge fully.*

Load software

Customize your device behavior through advanced settings and options with Poly Lens App. Some softphones require the installation of Poly software to enable device call control (answer/end and mute) functionality. Download: poly.com/lens.

NOTE *Device settings and updates are also available in Plantronics Hub App.*

Update your Poly device

Keep your firmware and software up-to-date to improve performance and add new features to your Poly device.

Update your device using your computer with Poly Lens Desktop App. Download at poly.com/lens.

While updating:

- Do not use your Poly device until the update is complete.
- Disconnect your Poly device from paired devices such as phones, tablets and computers.
- Do not start a second update from a second device.
- Do not stream media.
- Do not answer or place a call.

The basics

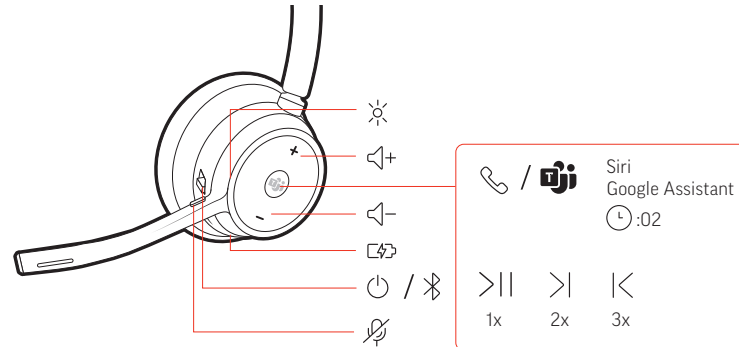

Power on/off

Slide the switch to power on or off.

Adjust the volume

Tap the Volume up (+) or down (-) button.

Adjust headset microphone volume (softphone)

Place a test softphone call and adjust softphone volume and PC sound volume accordingly.

Adjust voice prompt volume

To adjust the volume of voice alerts and prompts, toggle the volume switch up (+) or down (-) while not on a call or streaming audio.

Make/Take/End Calls

Answer or end a call

Tap the Call button.

Answer a second call

First, tap the Call button to end current call, then tap the Call button again to answer new call.

Mute

While on an active call, tap the red Mute button.

Hold a call

To hold an active call, press the headset Mute button for 2 seconds. Press the Mute button to resume a held call.

Switch between calls (flash)

To switch between calls, press the Mute button for 2 seconds.

Call back last call (smartphone)

To dial your last number you dialed, double-tap the Call button.

Answer calls from a second device

It's easy to answer calls from two devices (including softphone).

When on a call, you hear a ringtone notification of the incoming call from the second paired device.

To answer a second call from the other device, first tap the Call button to end the current call and tap the Call button again to answer the new call. If you choose to not answer the second call, it will go to voicemail.

Launch Microsoft Teams (Teams model only)

Tap your headset Teams  button to quickly open and use the Microsoft Teams desktop app.

- When not on a call, tap your Teams  button to view Microsoft Teams app on your computer.
- When your connected USB adapter LED pulses purple, tap your Teams button to view Teams notifications.



NOTE *Teams model and Teams desktop application required. Teams mobile application is not supported.*

Play or pause audio

Tap the Call  button to pause or resume streaming audio.



NOTE *Functionality varies by application. May not function with web-based apps.*

Track selection

Double-tap the Call  button to skip to the next track or triple-tap the Call  button to play the previous track.

NOTE *Functionality varies by application. May not function with web-based apps.*

Fast forward/rewind

Double-tap and hold the Call  button to fast-forward. Triple-tap and hold the Call  button to rewind.

NOTE *Functionality varies by application. May not function with web-based apps.*

Voice assistant

Siri, Google Assistant™, Cortana Press and hold the Call button for 2 seconds to activate your phone's default voice assistant. Wait for the phone prompt to activate voice dialing, search, and other smartphone voice controls.

More Features

- Select language** You can wirelessly change your headset language using Poly Lens App. Download: poly.com/lens.
- Adjust voice prompt volume**
To adjust the volume of voice alerts and prompts, toggle the volume switch up (+) or down (-) while not on a call or streaming audio.
- DeepSleep Mode** If you leave your headphones powered on but out of range of your paired phone or USB adapter for more than 7 days, your headset conserves its battery power by entering into DeepSleep mode.
Once back in range with your phone or USB adapter, press the Call control  button to exit DeepSleep mode.
- Online indicator** Your headset LED illuminates red to inform others that you are on a call. Manage settings in Poly Lens App.
- Corded mode (audio over USB)** If your audio is cutting out during softphone calls, you may be experiencing Bluetooth density problems. Improve audio performance by using density-friendly corded mode.
- 1 Disconnect your Bluetooth USB adapter from your computer
 - 2 Connect your headset directly to your computer with the provided 1.5 m USB cable
 - 3 Power off your headset to use density-friendly corded mode
- NOTE** *Your headset battery charges while in corded mode.*

Troubleshooting

How do I pair my headset to a mobile device?	See Pair to mobile device .
How do I pair my headset to a computer or laptop?	Plug in the USB Bluetooth adapter to your computer or laptop. The adapter is paired to your headset and connects to computer audio. See Connect to PC .
Why should I use the USB Bluetooth adapter instead of my computer's Bluetooth?	Your USB Bluetooth adapter provides the best connection, softphone functionality and acoustic sound quality through your headset. See Connect to PC, Configure USB adapter .
How do I pair my USB Bluetooth adapter to another supported Poly audio device?	Poly Lens Desktop App is required to pair your BT700 USB Bluetooth adapter to another device. Your Bluetooth adapter remembers up to 2 supported Poly audio devices, but connects to only one at a time. See Pair USB adapter again .
Can I connect my headset to a mobile phone and computer at the same time?	Yes, your headset can connect to mobile and PC. Your headset remembers up to 8 devices, but connect to up to 2 devices at a time. That includes the USB Bluetooth adapter.
The headset audio is not working as expected when connected to my computer. <ul style="list-style-type: none">• During a call, nobody can hear me• During a call, I can't hear anybody• Music is not coming through my headset• When I play music and a call comes in, the music is too loud or doesn't pause	Check the following: <ul style="list-style-type: none">• To configure the headset sound on your computer, see Configure USB adapter.• Ensure that only one softphone application is opened at a time.• For best performance, ensure your headset firmware is up-to-date. See Update your Poly device.
My headset call control is not working as expected when on a softphone call.	Check the following: <ul style="list-style-type: none">• For best performance, ensure your headset firmware is up-to-date. See Update your Poly device.• Ensure that only one softphone application is opened at a time.• If required to enable headset control (answer/end and mute) functionality, ensure you have Poly Lens Desktop App installed. See Load software.• Select your softphone application in Poly Lens Desktop App.
How do I lower the volume of voice prompts?	See Adjust voice prompt volume .
(Teams model only) How do I interact with Microsoft Teams using my headset?	<ul style="list-style-type: none">• Tap the headset Call  button to quickly open and use Microsoft Teams. See Launch Microsoft Teams.• Set your target softphone by going to Poly Lens Desktop App

(Teams model only) Does my Microsoft Teams-enabled headset work with other softphones?

Yes, while your headset is optimized for Microsoft Teams, it can be configured to use with other supported softphones. Set your target phone by going to Poly Lens Desktop App.

When you configure another softphone, the Call button:

- doesn't interact with Teams
- doesn't go to Teams notifications
- will not launch Cortana

I want to customize my headset features.

Customize your device settings with Poly Lens App. Download: poly.com/lens

The headset audio is cutting out during softphone calls.

You may be experiencing Bluetooth density issues. Use density-friendly corded mode. See [Corded mode \(audio over USB\)](#).

I want to use my headset as a USB corded headset with my computer.

Your headset can be used in corded mode. See [Corded mode \(audio over USB\)](#).

Can I use my headset while charging it?

Your headset charges while in corded mode. See [Corded mode \(audio over USB\)](#).

The headset talk time is not accurate.

Deplete your headset battery and then fully charge to reset the accuracy of the talk time prompts.

I don't have enough charge ports for my Bluetooth USB adapter and my optional charge stand.

Try the following:

- Plug your charge stand into a wall charger
- To charge your headset while connected to your computer, use corded mode. See [Corded mode \(audio over USB\)](#).

What's in the box

Contents may vary by model.



Stereo or mono headset

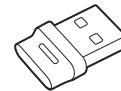

Bluetooth USB adapter (USB-A or USB-C, design varies)

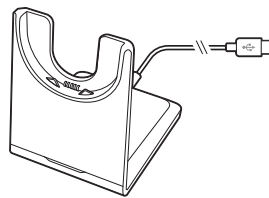

Charge stand (select models only)

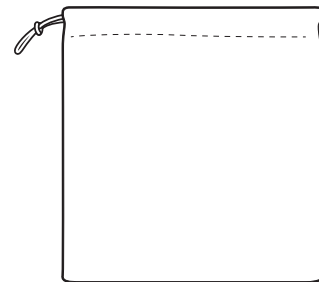

Headset carrying case

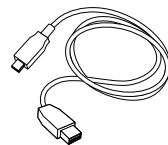

USB-A to USB-C cable

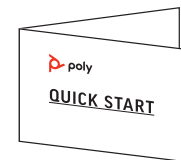

Quick start guide

Support

NEED MORE HELP?

poly.com/support

Manufacturer:

Plantronics, Inc.
345 Encinal Street
Santa Cruz, CA 95060
United States

Plantronics B.V.
Scorpius 171
2132 LR Hoofddorp
Netherlands

Plantronics Ltd.
Building 4, Foundation Park
Cannon Lane, Part 1st Floor
Maidenhead, SL6 3UD
United Kingdom

© 2023 Poly. Bluetooth is a registered trademark of Bluetooth SIG, Inc. All trademarks are the property of their respective owners. Manufactured by Plantronics, Inc.

Model ID: Headset: V4310/V4310-M/V4320/V4320-M, Adapter: BT700/BT700C, Charge Stand: CB4300. System: Poly Voyager 4300 UC Series has a V4310/V4310-M/V4320/V4320-M headset, a BT700/BT700C adapter and may include a CB4300 charge stand.

220245-06 01.23