

COCOON™  
**VOYAGER**  
FPV



Model Number: HE160341

**INSTRUCTION MANUAL**



## Warranty Note

**If you experience any issues with this product, or it's performance is not what you had expected, please contact us at Winplus before returning the item to the store.**

**It is likely that we can resolve any problems for you via phone or email.**

**We can be reached on:**

**Phone: 1300 663 907 (Mon - Fri; 8:30am - 6:00pm EST)**

**Email: [customercare@winplus.com.au](mailto:customercare@winplus.com.au)**

**Web: [www.winplus.com.au](http://www.winplus.com.au)**

## Battery Note

- **Non-rechargeable batteries are not to be recharged.**
- **Rechargeable batteries are to be removed from the toy before being charged.**
- **Rechargeable batteries are only to be charged under adult supervision.**
- **Exhausted batteries are to be removed from the toy.**
- **The supply terminals are not to be short circuited.**



## VOYAGER QUADCOPTER FPV

# Warranty Details

---

The product is guaranteed to be free from defects in workmanship and parts for a period of 12 months from the date of purchase. Defects that occur within this warranty period, under normal use and care, will be repaired, replaced or refunded at our discretion. The benefits conferred by this warranty are in addition to all rights and remedies in respect of the product that the consumer has under the Competition and Consumer Act 2010 and similar state and territory laws.

Our goods come with guarantees that cannot be excluded under the Australian Consumer Law. You are entitled to a replacement or refund for a major failure and for compensation for any other reasonably foreseeable loss or damage. You are also entitled to have the goods repaired or replaced if the goods fail to be of acceptable quality and the failure does not amount to a major failure.

---

#### AFTER SALES SUPPORT



[customercare@winplus.com.au](mailto:customercare@winplus.com.au)

MODEL: HE160341 PRODUCT CODE: 54969 09/2016



# Safety Instructions

Follow all instructions and take notice of all warnings to reduce risk of fire or electric shock.

- Read the instructions in this manual thoroughly before operating your Cocoon Voyager Quadcopter FPV.
- This Cocoon Voyager Quadcopter FPV must be operated safely at all times. It is the operator's responsibility to always fly in safe conditions.
- Always check each component of the Voyager Quadcopter FPV is operating correctly before flying.
- Always follow local aviation rules and regulations when flying the Voyager Quadcopter FPV.
- This Cocoon Voyager Quadcopter FPV is designed for ages 14+.
- Adult supervision is always advisable with any form of flying toy.
- Always ensure your flight area is safe.
- If a problem occurs with the Cocoon Voyager Quadcopter FPV, always contact the supplier before attempting to fly again.
- Do not fly in windy, rainy or low light conditions.
- Non-rechargeable batteries are not to be recharged.
- Rechargeable batteries are to be removed from the toy before being charged.
- Rechargeable batteries are only to be charged under adult supervision.
- Exhausted batteries are to be removed from the toy.
- The supply terminals are not to be short-circuited.

Winplus Australasia will not take any responsibility for incorrect use of the Cocoon Voyager Quadcopter FPV.

## After Sales Support



1300 663 907



customercare@winplus.com.au

Model Number HE160341

# Rules & Regulations

The following regulations must be followed when operating your Cocoon Voyager Quadcopter FPV in Australia.

- You must only operate this aircraft in your line-of-sight in daylight.
- You must not fly closer than 30 metres to vehicles, boats, buildings or people.
- You must not fly over populous area, such as beaches, other people's backyards, heavily populated parks, or sports ovals where there is a game in progress.
- If you are in controlled airspace, which covers most Australian cities, you must not fly higher than 120 meters (400 feet).
- You should not fly within 5.5 km of an airfield.
- It's illegal to fly for money or economic reward unless you have an unmanned operator's certificate issued by the Civil Aviation Safety Authority (CASA).

Source: [http://www.casa.gov.au/wcmswr/\\_assets/main/lib100071/flying\\_with\\_control\\_model.pdf](http://www.casa.gov.au/wcmswr/_assets/main/lib100071/flying_with_control_model.pdf)

It is the Voyager Quadcopter FPV operator's responsibility to regularly check and abide by the current rules and regulations.

Incorrect operation of this Cocoon Voyager Quadcopter FPV may result in severe injury, loss of property or fines.

Winplus Australasia does not take any responsibility if local rules and regulations are not followed.

## After Sales Support

 1300 663 907

 [customercare@winplus.com.au](mailto:customercare@winplus.com.au)

**Model Number** HE160341

# Contents

|   |           |
|---|-----------|
| <b>Warranty Details</b>   | <b>3</b>  |
| <b>Safety Instructions</b>  | <b>4</b>  |
| <b>Rules &amp; Regulations</b>  | <b>5</b>  |
| <b>Parts List</b>   | <b>7</b>  |
| <b>Technical Specifications</b>   | <b>7</b>  |
| <b>Features</b>   | <b>7</b>  |
| <b>Product Overview</b>   | <b>8</b>  |
| 1.1 Cocoon Voyager Quadcopter FPV   | <b>8</b>  |
| 1.2 Remote Control - Buttons  | <b>8</b>  |
| 1.3 Remote Control - Display  | <b>9</b>  |
| <b>Installation</b>   | <b>10</b> |
| 2.1 Installing the Control Batteries  | <b>10</b> |
| 2.2 Installing Landing Skids and Blade Guards   | <b>10</b> |
| 2.3 Charging and Inserting the Voyager Quadcopter Battery   | <b>10</b> |
| 2.4 Install the Camera  | <b>11</b> |
| 2.5 Connecting Phone Clamp onto Remote Control  | <b>12</b> |
| 2.6 Installing FPV Software and pairing the Cocoon Voyager Quadcopter FPV with the Remote Control | <b>12</b> |
| <b>Operation</b>  | <b>13</b> |
| 3.1 Flying the Cocoon Voyager Quadcopter FPV  | <b>13</b> |
| 3.2 Fine Tuning   | <b>14</b> |
| 3.3 2. Using 'DRONE FPV' App and the Camera   | <b>14</b> |
| 3.4 Speed Control   | <b>15</b> |
| 3.5 Tricks  | <b>15</b> |
| 3.6 Mid Air Start   | <b>15</b> |
| 3.7 Changing to Mode 2  | <b>15</b> |
| 3.8 Mode 2: Flying  | <b>16</b> |
| 3.9 Mode 2: Fine Tuning   | <b>16</b> |
| 3.10 Resetting the Cocoon Voyager Quadcopter FPV  | <b>17</b> |
| 3.11 Replacing Propellor Blades   | <b>17</b> |
| <b>FAQs</b>   | <b>18</b> |
| <b>Repair and Refurbished Goods or Parts Notice</b>   | <b>19</b> |

## After Sales Support

 1300 663 907

 [customercare@winplus.com.au](mailto:customercare@winplus.com.au)

**Model Number** HE160341

# Parts List

|                                     |                              |                          |
|-------------------------------------|------------------------------|--------------------------|
| 1x Cocoon Voyager<br>Quadcopter FPV | 1x Phone Clamp               | 4x Landing Skids         |
| 1x 2.4GHz Remote Control            | 1x Screwdriver               | 4x Additional Blades     |
| 1x USB Charging Cable               | 1x WIFI Camera               | 1x Instruction Manual    |
| 1x Rechargeable Battery             | 4x AA Activ Energy Batteries | 1x Getting Started Guide |
|                                     | 4x Propeller Guards          | 1x Warranty Certificate  |

**NOTE:** See bottom of blister for Screwdriver and Landing Skids



# Technical Specifications

|                             |                           |
|-----------------------------|---------------------------|
| Frequency:                  | 2.4GHz                    |
| Channel:                    | 4CH                       |
| Gyro:                       | 6 axis                    |
| Quadcopter Size:            | 31.4 x 31.4 x 8.9cm       |
| Quadcopter Weight:          | 0.136kg                   |
| Flight time:                | 6-7 minutes per charge    |
| Charging time:              | Approx. 100 minutes       |
| Control distance:           | Approx. 45m               |
| Battery for quadcopter:     | 3.7V 500mAh               |
| Battery type:               | Li-ion                    |
| Battery for Remote Control: | 4 x AA battery (included) |

# Features

FPV (First Person View) transmission to any iOS or Android smart phone to view and record videos and photos

Headless and inverse control function

6-Axis gyro quad-rotorcraft flight for strong stability, movement, stronger wind resistance and easier to control.

2.4GHz technology for anti-interference and RC range

One key 360° flip feature

Detachable WIFI 640 x 480 resolution camera

## After Sales Support

 1300 663 907

 [customercare@winplus.com.au](mailto:customercare@winplus.com.au)

**Model Number** HE160341

# Product Overview

## 1.1 Cocoon Voyager Quadcopter FPV

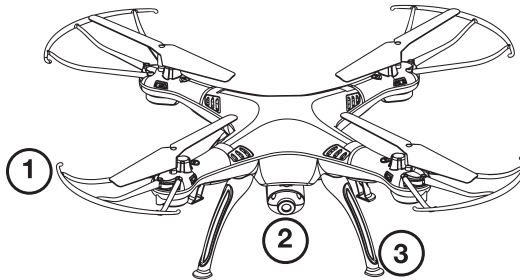

1. Propeller Guards

2. Camera

3. Landing Skids

## 1.2 Remote Control - Buttons

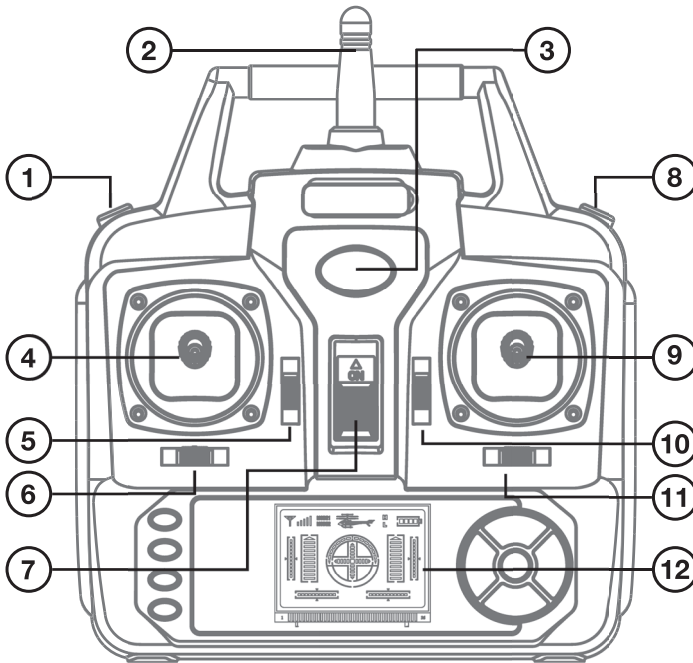

1. High/Low Speed Button

5. Photo/Video Switch

9. Right Control Stick

2. Antenna

6. Left Tuning Switch

10. Forward/Back Trim

3. Indicator

7. On/Off Switch

11. Mode Switch

4. Left Control Stick

8. Trick Button

12. LCD Display

### After Sales Support

1300 663 907



customercare@winplus.com.au

Model Number HE160341



# Product Overview

## 1.3 Remote Control - Display

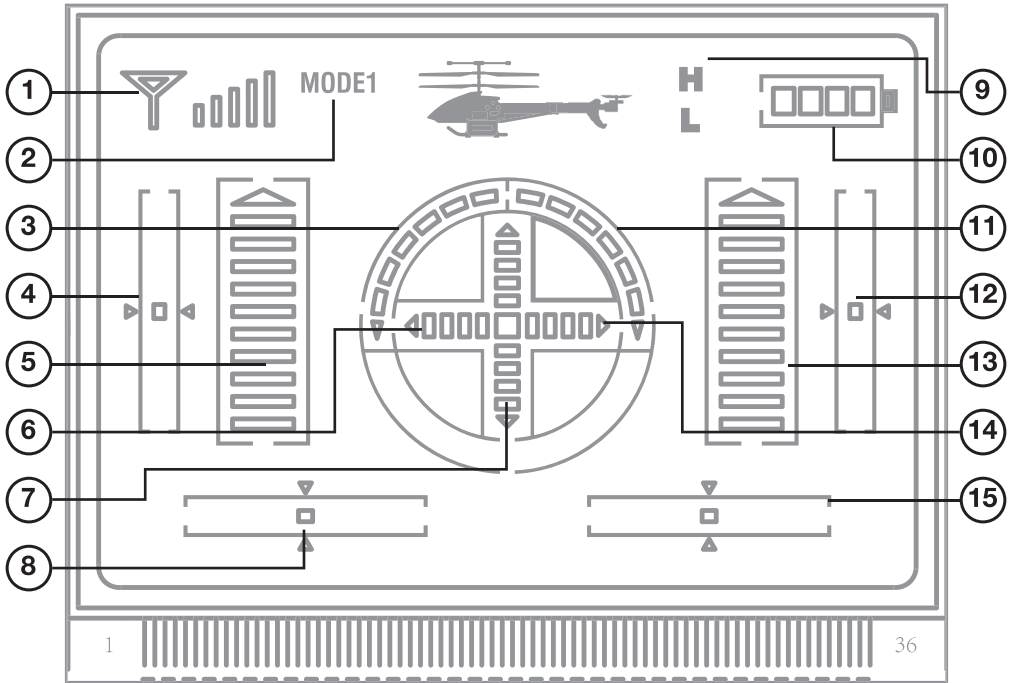

- |                                  |                                   |                                     |
|----------------------------------|-----------------------------------|-------------------------------------|
| 1. Signal Indicator              | 7. Backward                       | 12. Forward/Backward<br>Fine-tuning |
| 2. Mode Indicator                | 8. Turn Left/Right<br>Fine-tuning | 13. Throttle                        |
| 3. Turn Left                     | 9. High/Low Speed<br>Indicator    | 14. Left                            |
| 4. Throttle Lever<br>Fine-tuning | 10. Control Battery Level         | 15. Sideways Fine-tuning            |
| 5. Throttle                      | 11. Turn Right                    |                                     |
| 6. Right                         |                                   |                                     |

### After Sales Support

 1300 663 907

 [customercare@winplus.com.au](mailto:customercare@winplus.com.au)

Model Number HE160341

# Installation

## 2.1 Installing the Control Batteries

- Use a screwdriver to remove the screw on the back of the remote control, then open the battery cover.
- Install 4x AA batteries into the back of the remote control. Please note the polarity positions indicated.
- Replace the cover and reinstall the screw.

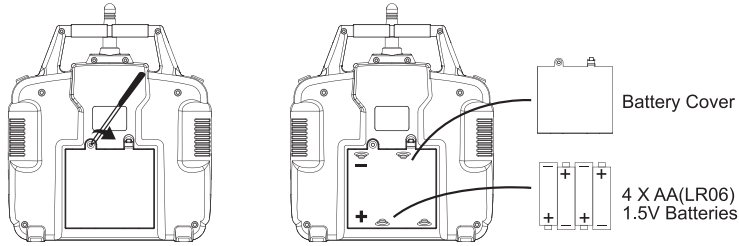

**NOTE:** For best performance, do not mix different types of batteries.

## 2.2 Installing Landing Skids and Propeller Guards

- Insert the Landing Skids to the bottom of the Cocoon Voyager Quadcopter FPV as shown below and screw into place.
- Insert the Propeller Guards onto each of the wings as shown below.
- Secure the Propeller Guards with screws.

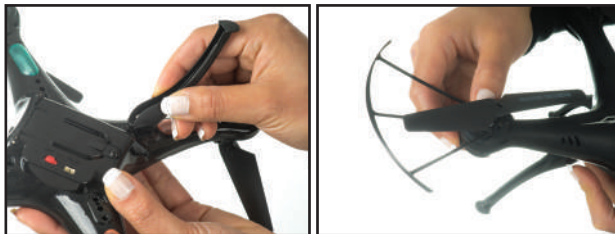

## 2.3 Charging and Inserting the Voyager Quadcopter FPV Battery

- Insert the battery power port into the small end of the USB charging cable.
- Insert the other end of the USB charging cable into a USB port. The charging indicator will now turn on.
- Once the charging indicator has turned off, the battery is fully charged.



### After Sales Support

 1300 663 907

 [customercare@winplus.com.au](mailto:customercare@winplus.com.au)

Model Number HE160341

# Installation

- d. Disconnect the USB cable from the USB port.
- e. Disconnect the battery power port from the small end of the USB charging cable.
- f. Connect the battery wire to the power port on the Cocoon Voyager Quadcopter FPV and insert battery into the base.
- g. Close the battery cover. To ensure it is securely closed, push cover in until it snap-locks into place.



- NOTE:**
- Always charge in a dry and ventilated area
  - Always remove the battery from the quadcopter when charging
  - Do not charge the battery if the surface is still warm
  - Only use the original USB charging cable provided
  - Replace the battery if it becomes swollen

## 2.4 Install the Camera

- a. Insert the camera onto the base of the Cocoon Voyager Quadcopter FPV.
- b. Connect the camera wires to the 'Plug' Port next to the ON/OFF Switch.

**NOTE:** To remove the camera, unplug the wire, press the camera release button to slide the camera out. Refer to image below:



### After Sales Support

 1300 663 907

 [customercare@winplus.com.au](mailto:customercare@winplus.com.au)

Model Number HE160341

## 2.5 Connecting Phone Clamp onto Remote Control

- a. Insert the Phone Clamp connector onto the antenna of the Remote Control as illustrated.
- b. Press the ends of the Phone Clamp to open and insert Smart Phone. Release to secure device. Ensure device is secure and does not move before proceeding.
- c. To remove Phone Clamp, press the ends of the Phone Clamp to open and remove device. Then, pull out connector from the Remote Control's antenna.



## 2.6 Installing FPV Software and pairing the Cocoon Voyager Quadcopter FPV with the Remote Control

**NOTE:** Ensure you have followed the steps above prior to connecting the Cocoon Voyager Quadcopter FPV wirelessly and pairing with the Remote Control



**Drone FPV  
Icon**

- a. Scan the QR code at the side of the box or download 'DRONE FPV' App from the App Store or Google Play.
- b. Set the switch on the Cocoon Voyager Quadcopter FPV to 'ON' and place it on a flat, horizontal surface.
- c. On the Remote Control, set the power switch located in the centre to the 'ON' position.
- d. Push the Left Control Stick to the highest position until you hear the Remote Control beep, then pull down to the lowest position until you hear another beep.
- e. Open Wi-Fi Settings on your smart phone and look for 'FPV\_WIFI\_xxxx' (xxxx being your Voyager Quadcopter FPV's unique code) to connect your phone to the Cocoon Voyager Quadcopter FPV's Camera.
- f. Once Wi-Fi is connected, open the 'DRONE FPV' App to view footage on your phone.

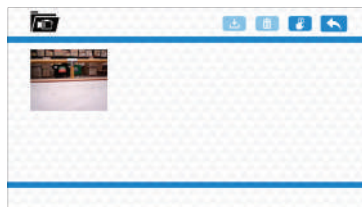

### After Sales Support

 1300 663 907

 [customercare@winplus.com.au](mailto:customercare@winplus.com.au)

**Model Number** HE160341

# Operation

## 3.1 Flying the Cocoon Voyager Quadcopter FPV

**WARNING:** Incorrect operation of the Cocoon Voyager Quadcopter FPV may result in severe injury, loss of property or fines. Winplus Australasia does not take any responsibility if local rules and regulations are not followed. Do not fly above 3 metres until you can accurately control the Cocoon Voyager Quadcopter FPV. Loss of the Cocoon Voyager Quadcopter FPV is not covered by warranty.

**TIP:** The best way to know which direction the Cocoon Voyager Quadcopter FPV is facing is by the coloured LEDs on its' wings. The red lights will face forwards, while the green lights face backwards. Always keep the Cocoon Voyager Quadcopter FPV in direct line of sight.

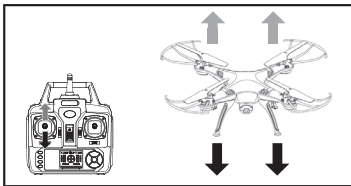

### Hover up and down:

Push the left control stick up or down. The Voyager Quadcopter FPV will fly upward or downward.

**TIP:** If you begin to lose control of your Voyager Quadcopter, turning the remote control off will stop the propellers turning and bring it back to the ground.

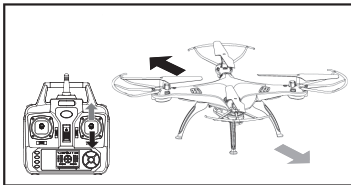

### Forward and backward:

Push the right control stick up or down. The Voyager Quadcopter FPV will fly forward or backward.

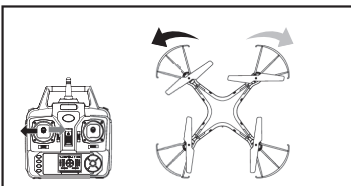

### Turn Left and Right:

Pull the left control stick left or right. The Voyager Quadcopter FPV will turn left or right.

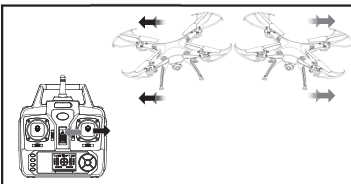

### Sideward fly:

Pull the right control stick left or right. The Voyager Quadcopter FPV will fly left or right.

### After Sales Support

 1300 663 907

 [customercare@winplus.com.au](mailto:customercare@winplus.com.au)

Model Number HE160341

# Operation

## 3.2 Fine Tuning

The Voyager Quadcopter FPV should keep steady when using the left control stick only. At times however, you may need to fine tune the control to keep the Voyager Quadcopter FPV steady. Depending on the issue, use the following buttons to fine tune the Voyager Quadcopter FPV;



### Flying forward/backwards:

Use the forward/back switch.

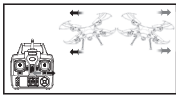

### Flying left/right:

Use the mode switch.

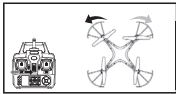

### Rotating left/right:

Use the left tuning switch.

**NOTE:** The amount of fine tuning is indicated on the remote control LCD display.

## 3.3 Using 'DRONE FPV' App and the Camera

### Using the camera

- Ensure the Phone Clamp is secured onto the Antenna of the Remote Control, and your Smart Phone is connected to the Cocoon Voyager Quadcopter FPV via Wi-Fi.
- Place your phone onto the Phone Clamp. Open the 'DRONE FPV' App on your iOS/Android Device. Press the 'Start' Button to view camera .

### Taking a Photo

- Press the Photo Icon to take a photo .

**NOTE:** You can view the photos taken by selecting the  icon and .

### Taking a Video

- Press the Recording Icon to take a video .
- To stop recording, press the Recording Icon and video will be saved into the folder.

**NOTE:** You can view the recorded videos by selecting the  icon and .

### After Sales Support

 1300 663 907

 [customercare@winplus.com.au](mailto:customercare@winplus.com.au)

Model Number HE160341

# Operation

## 3.4 Speed Control

This camera drone can be operated at low speed and high speed settings. These are indicated by the 'L' and 'H' on the remote control display.

To change between low and high speed, press the 'High / Low Speed Button' on the top left corner of the control.

## 3.5 Tricks

Once you are familiar with basic flight operations, you can:

1. Fly the Voyager Quadcopter FPV to a height of more than 3 metres.
2. Hold down the Trick button on the top right side of the remote control.
3. While still holding down the Trick button, push the right control stick in any direction to perform a 360 degree flip.

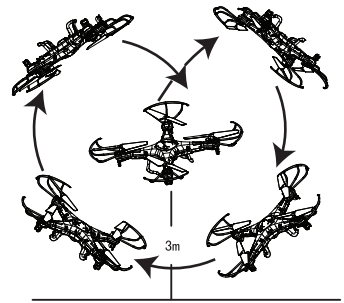

## 3.6 Mid Air Start

Thanks to the 6-axis gyroscope, you can throw the Voyager Quadcopter FPV and push the throttle upwards. The Voyager Quadcopter FPV will automatically level out and hover smoothly in the sky.

## 3.7 Changing to Mode 2

This Cocoon Voyager Quadcopter FPV allows you to swap the sideward control with turn left/right control.

- a. With the remote control turned off, hold the mode switch to the right.
- b. Turn on the Remote Control. A longer beep sound will indicate that the mode has been changed. You will also notice that Mode 2 is now shown on the control display.

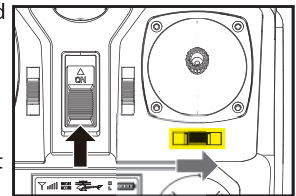

**NOTE:** To return to Mode 1, perform these steps again.

### After Sales Support

 1300 663 907

 [customercare@winplus.com.au](mailto:customercare@winplus.com.au)

Model Number HE160341

# Operation

## 3.8 Mode 2: Flying

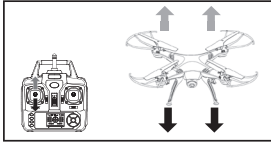

### Hover up and down:

Push the left control stick up or down. The Voyager Quadcopter FPV will fly upward or downward.

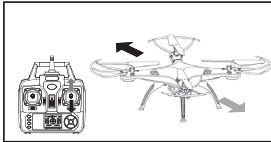

### Forward and backward:

Push the right control stick up or down. The Voyager Quadcopter FPV will fly forward or backward.

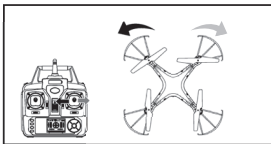

### Turn Left and Right:

Pull the right control stick left or right. The Voyager Quadcopter FPV will turn left or right.

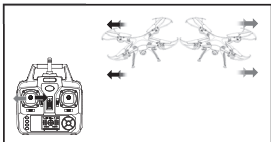

### Sideward fly:

Pull the left control stick left or right. The Voyager Quadcopter FPV will fly left or right.

## 3.9 Mode 2: Fine Tuning

Depending on the issue, use the following buttons to fine tune the Voyager Quadcopter FPV;



### Flying forward/backwards:

Use the forward/backward switch.

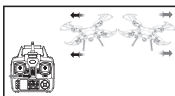

### Flying left/right:

Use the left tuning switch.

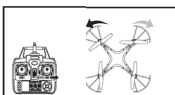

### Rotating left/right:

Use the mode switch.

## After Sales Support

 1300 663 907

 [customercare@winplus.com.au](mailto:customercare@winplus.com.au)

Model Number HE160341



# Operation

## 3.10 Resetting the Cocoon Voyager Quadcopter FPV

In the event of the Cocoon Voyager Quadcopter FPV flying strangely, first check that there is no issue with fine tuning on the Remote Control.

If fine tuning did not solve the issue, you can reset the Cocoon Voyager Quadcopter FPV to factory settings with this method:

- Perform the steps in "Pairing the Voyager Quadcopter FPV with the Control" to pair with the Cocoon Voyager Quadcopter FPV.
- Hold both Remote Control levers at their bottom right position. The Cocoon Voyager Quadcopter FPV LED's will flash rapidly.
- After 2-3 seconds, the LED's will return to normal. This indicates that the Cocoon Voyager Quadcopter FPV has restarted and reset successfully.

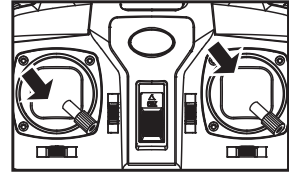

## 3.11 Replacing Propeller Blades

Eventually your propeller blades may need to be replaced. Do not operate the Cocoon Voyager Quadcopter FPV with damaged propeller blades as you may suddenly lose control of the Voyager Quadcopter FPV during flight. Follow the steps below to replace your Voyager Quadcopter FPV's propeller blades.

- Position the Cocoon Voyager Quadcopter FPV on a level, horizontal surface with the front end facing forward, as shown below.
- Determine which blades need replacing and note the blade warning text side (left or right) by checking the top of the blade.
- Using the screwdriver provided, unscrew the damaged blade.



Left Side



Right Side

- Replace the blade with the same type (left or right), also checking the diagram below to confirm the correct blade type.
- Screw in the replacement blade firmly using the screw that was removed in step c.
- When flying your Voyager Quadcopter FPV again, gently increase the throttle to check that the Voyager Quadcopter FPV will remain stable when flying. If the incorrect blade type is used, the Voyager Quadcopter will be unable to remain level.

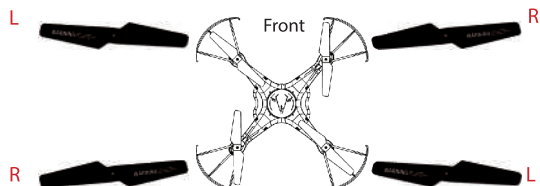







### After Sales Support

1300 663 907

[customercare@winplus.com.au](mailto:customercare@winplus.com.au)

Model Number HE160341

# FAQs

| Question  | Solution   |
|---|--|
| My Cocoon Voyager Quadcopter FPV didn't pair with my Remote Control | At times the Cocoon Voyager Quadcopter FPV may fail to pair with the Remote Control. Attempt to pair again, ensuring the Cocoon Voyager Quadcopter FPV is resting on a level surface.  |
| My Cocoon Voyager Quadcopter FPV isn't responding                   | Check that the battery in the Cocoon Voyager Quadcopter FPV is still charged. Also check that the Remote Control batteries are still charged.  |
| My Cocoon Voyager Quadcopter FPV is slow to respond                 | Ensure that the Remote Control batteries are still charged. There may also be interference from a similar frequency nearby. Try using the Cocoon Voyager Quadcopter FPV in a different location, away from other radio controlled devices.   |
| Not flying straight or spinning                                     | Follow the steps in 'Fine Tuning' to configure the Cocoon Voyager Quadcopter FPV correctly. If unsuccessful, try following the steps in 'Resetting the Cocoon Voyager Quadcopter FPV'.   |
| How do I see photos and pictures on my phone?                       | Open the DRONE FPV app > Start >  >  or <br>> Tap photo or video to view                        |
| How do I transfer photos to my camera roll in iOS?                  | Open the DRONE FPV app > START >  >  or  > SELECT > Tap photo or video to transfer > ADD TO ALBUM |
| How do I transfer photos or videos to my computer in iOS?           | First transfer photos or videos to your camera roll using the instructions above, then download to your computer per your devices instructions.  |
| How do I transfer photos or videos to my computer in Android?       | Connect your Android mobile to your computer. Navigate to the root > DRONE directory to find your photos and videos. Copy them to your computer.   |

## After Sales Support

 1300 663 907

 [customercare@winplus.com.au](mailto:customercare@winplus.com.au)

Model Number HE160341



## VOYAGER QUADCOPTER FPV

# Repair and Refurbished Goods or Parts Notice

---

Unfortunately, from time to time, faulty products are manufactured which need to be returned to the Supplier for repair.

Please be aware that if your product is capable of retaining user-generated data (such as files stored on a computer hard drive, telephone numbers stored on a mobile telephone, songs stored on a portable media player, games saved on a games console or files stored on a USB memory stick) during the process of repair, some or all of your stored data may be lost.

**We recommend you save this data elsewhere prior to sending the product for repair.**

You should also be aware that rather than repairing goods, we may replace them with refurbished goods of the same type or use refurbished parts in the repair process.

**Please be assured though, refurbished parts or replacements are only used where they meet ALDI's stringent quality specifications.**

If at any time you feel your repair is being handled unsatisfactorily, you may escalate your complaint. Please telephone us on 1300 663 907 or write to us at:

Winplus Australasia  
PO BOX 537  
Bayswater Business Centre  
Bayswater, VIC 3153

Winplus Help Desk 1300 663 907  
(Operating Hours: Mon-Fri 08:30AM to 6:00PM)

customercare@winplus.com.au  
www.winplus.com.au

---

#### AFTER SALES SUPPORT



 customercare@winplus.com.au

MODEL: HE160341 PRODUCT CODE: 54969 09/2016



COCOON™