

# SMARTCODE 916

TOUCHSCREEN ELECTRONIC DEADBOLT

## Programming and Troubleshooting Guide

<b>1</b>	Mastercode	2
<b>2</b>	Troubleshooting: Installation	10
<b>3</b>	Troubleshooting: Door Jamming and Door Handling	11
<b>4</b>	Troubleshooting: Touchscreen	14
<b>5</b>	Troubleshooting: Smart Home Systems	15
<b>6</b>	Troubleshooting: Battery	17
<b>7</b>	Battery FAQ	18

# 1 Mastercode

## A About the Mastercode

Using a Mastercode is an optional, added-security measure. It is not enabled by default. A Mastercode is used to add and delete user codes, but it cannot unlock the door (unless the same code is programmed as a user code, though this is not recommended). The Mastercode must be 4-8 digits.

## B Enabling and Setting the Mastercode

Programming timeout: If the screen is not pressed for 20 seconds, the system will time out (indicated by three beeps and the "X" pattern flashing three times), and you will need to restart the procedure.

1. Keep door open. Press and HOLD the Program button until the Checkmark symbol illuminates (about 5 seconds).

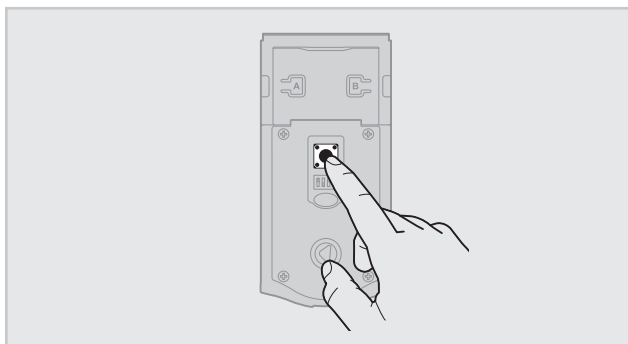

2. Press Checkmark symbol once.

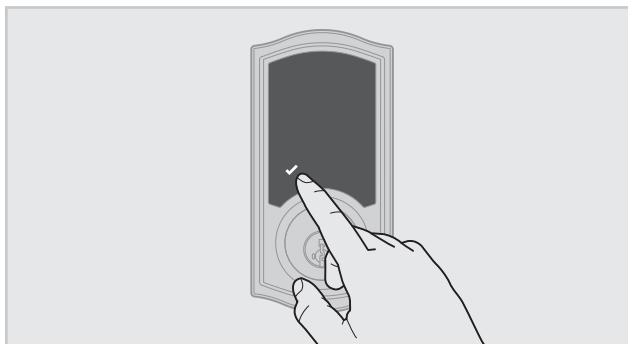

3. Enter new Mastercode.

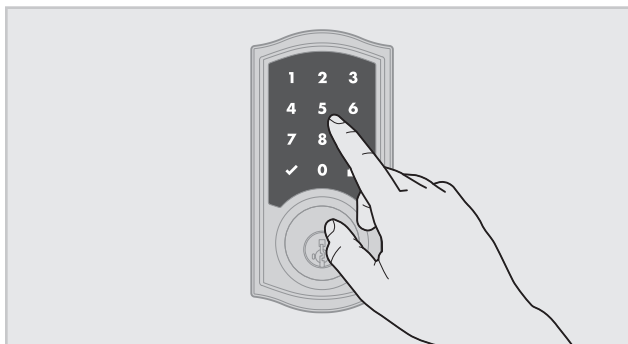

4. Press Lock symbol once.

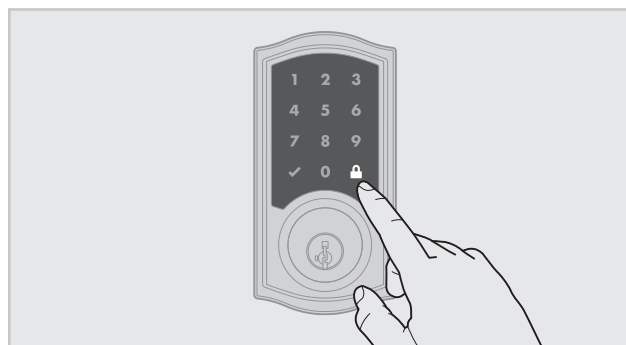

5. Re-enter Mastercode.

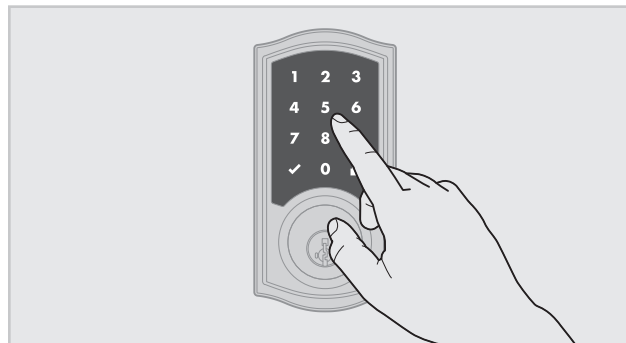

6. Press Lock symbol once.

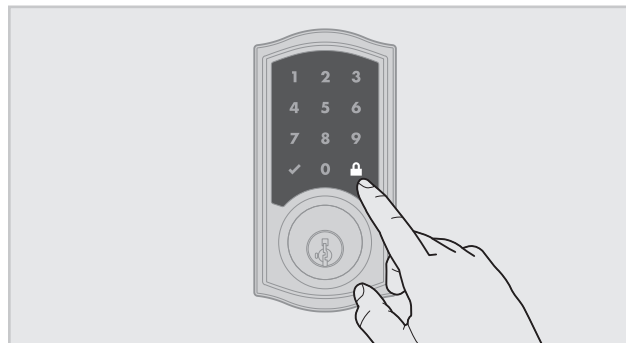

Procedure continued on next page

If programming is successful, the Checkmark will illuminate and you will hear one beep.

If programming is unsuccessful, the "X" pattern will flash three times, and you will hear three beeps. Make sure the Mastercode has not already been programmed. Attempt the procedure again, making sure to enter the same new Mastercode in step 3 and 5.

7. Make sure switch #3 is on, and press the Program button once. If you immediately hear five beeps and see the Checkmark flash five times, the Mastercode is enabled.

## C Adding User Codes with the Mastercode Enabled

The procedure for adding user codes is different when the Mastercode is enabled. For instructions on how to add user codes when the Mastercode is disabled, see the Installation and User Guide that came with your lock.

1. Keep door open. Press the Program button once. The Checkmark will flash five times and you will hear five beeps.

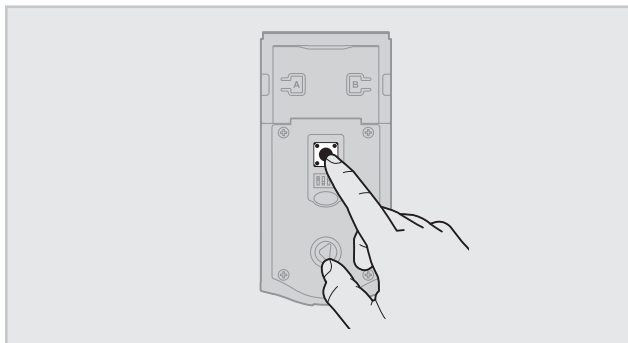

2. Press Checkmark symbol once.

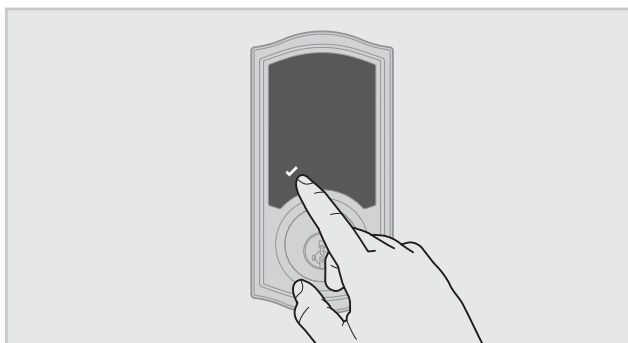

3. Enter Mastercode.

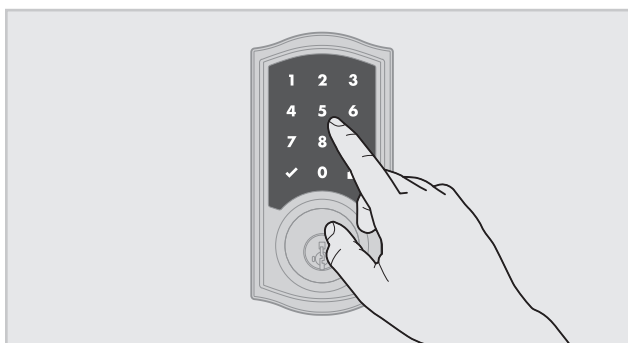

4. Press Lock symbol once.

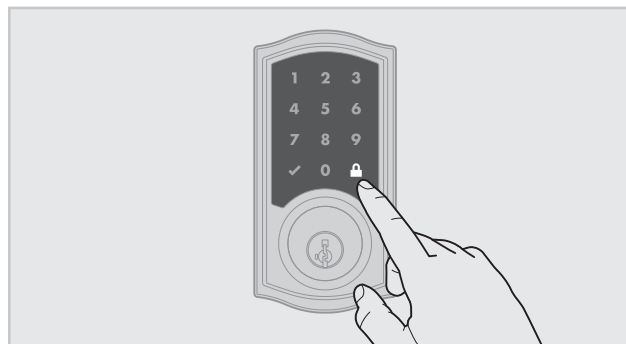

5. Enter new user code.

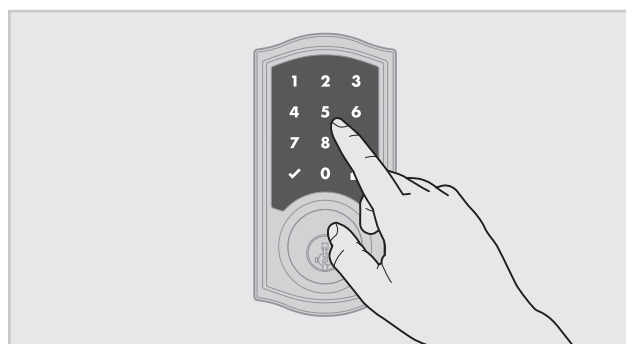

6. Press Lock symbol once.

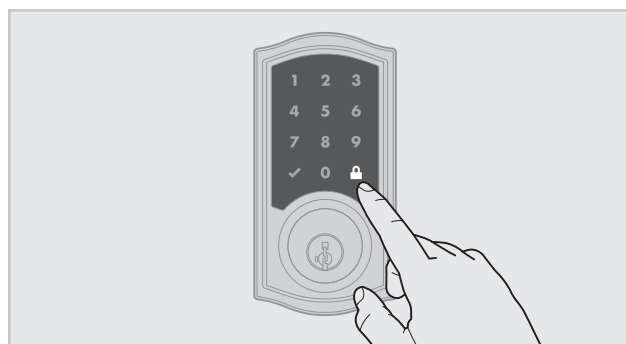

If programming is successful, the Checkmark will illuminate and you will hear one beep.

If programming is unsuccessful, the "X" pattern will flash three times with three beeps. Make sure the user code is not a duplicate and that it is between 4 and 8 digits during your next attempt. Make sure the lock has room for an additional code. If all user codes are filled, delete a code to make room for this one. Make sure to enter a valid Mastercode in step 3.

7. While the door is open and locked, test the user code to make sure it unlocks the door.

## D Deleting a Single User Code with the Mastercode Enabled

1. Keep door open. Press the Program button once. The Checkmark will flash five times and you will hear five beeps.

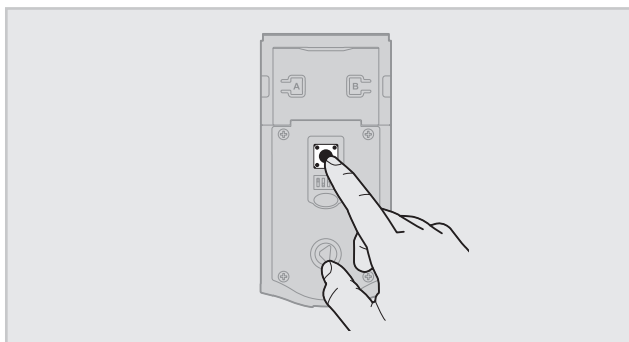

2. Press Checkmark symbol once.

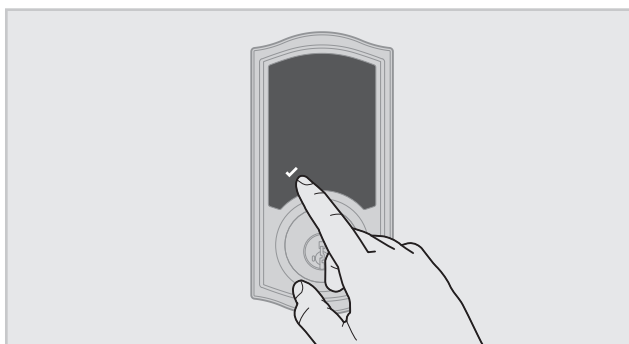

3. Press Lock symbol once.

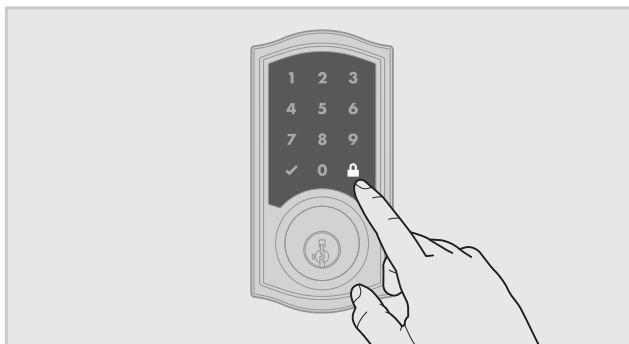

4. Enter Mastercode.

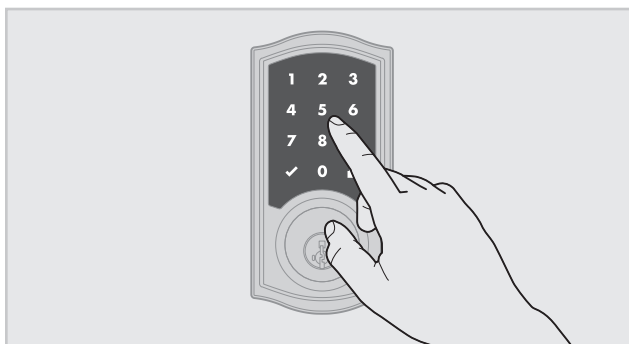

5. Press Lock symbol once.

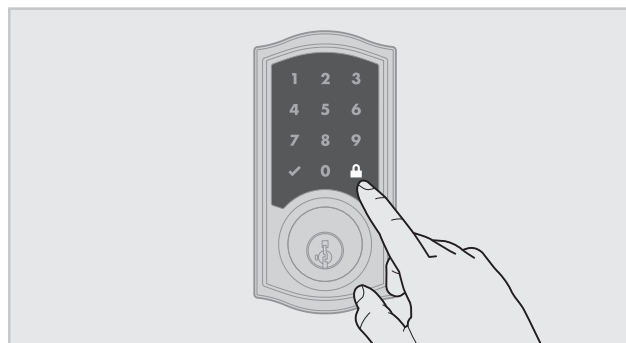

6. Enter user code to be deleted.

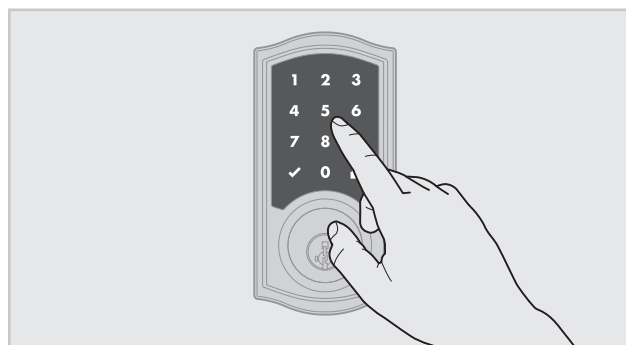

7. Press Lock symbol once.

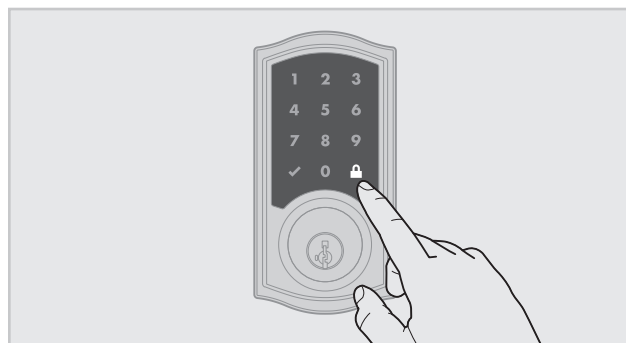

8. Re-enter user code to be deleted.

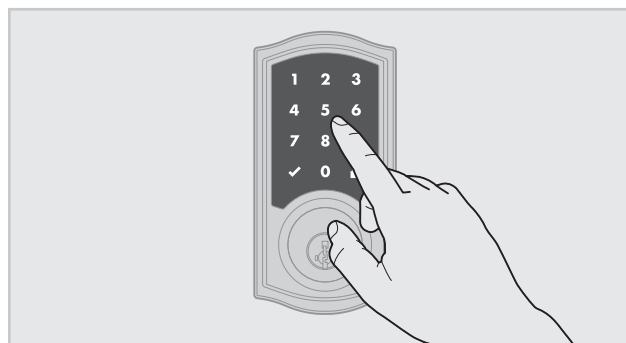

Procedure continued on next page

9. Press Lock symbol once.

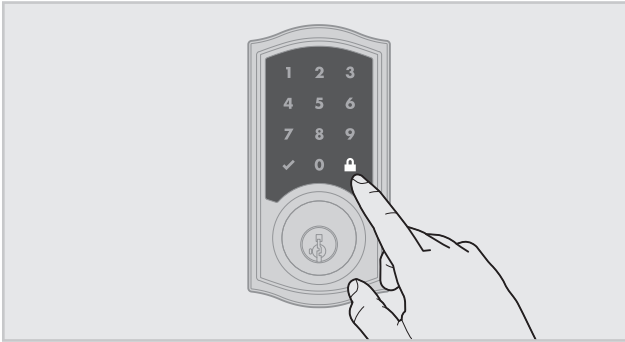

If programming is successful, the Checkmark will illuminate and you will hear one beep.

If programming is unsuccessful, the "X" pattern will flash three times with three beeps. Make sure to enter a valid Mastercode in step 4.

10. While the door is open and locked, test the user code to make sure it no longer unlocks the door.

## **E** Deleting All User Codes with the Mastercode Enabled

1. Keep door open. Press the Program button once. The Checkmark will flash five times and you will hear five beeps.

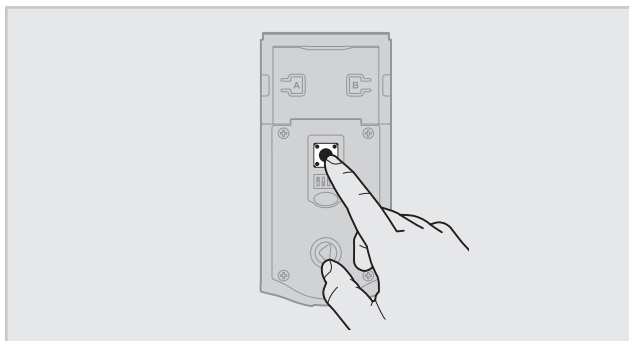

2. Press Checkmark symbol once.



3. Press Lock symbol once.

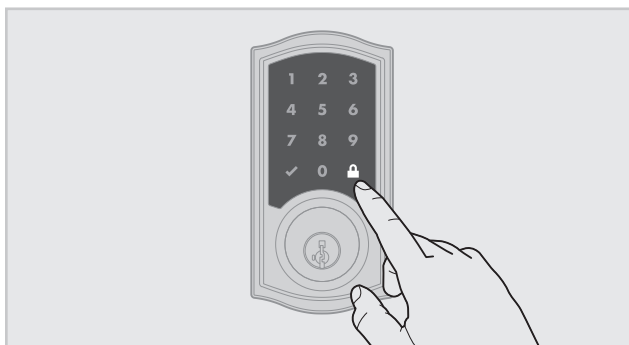

4. Enter Mastercode.

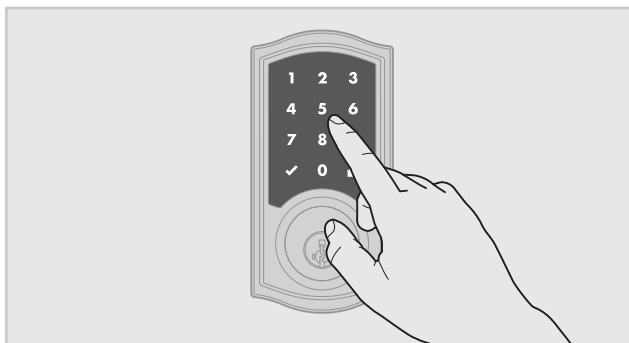

5. Press Lock symbol once.

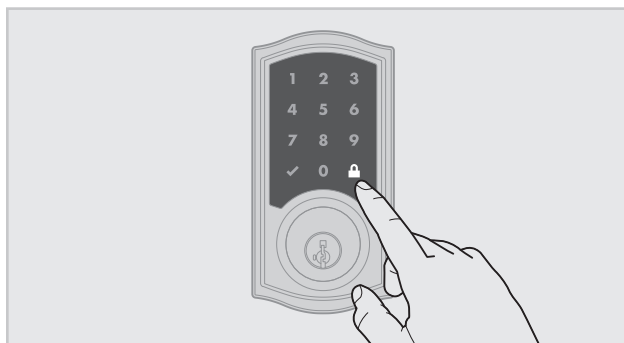

6. Press "9" six times.

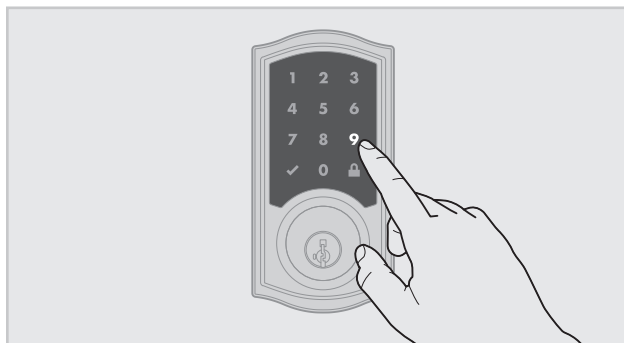

7. Press Lock symbol once.

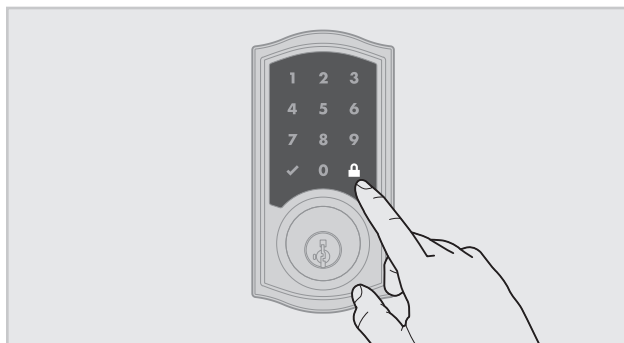

8. Press "9" six times.

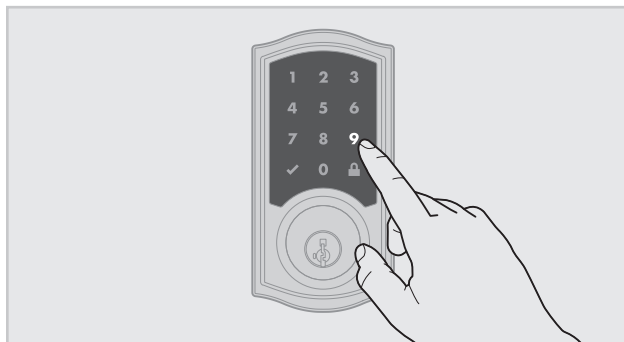

Procedure continued on next page

9. Press Lock symbol once.

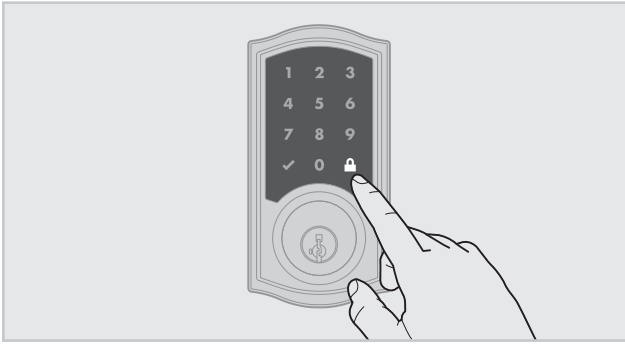

If programming is successful, the Checkmark will illuminate and you will hear one beep.

If programming is unsuccessful, the "X" pattern will flash three times with three beeps. Make sure to enter a valid Mastercode in step 4 during your next attempt.

10. While the door is open and unlocked, press the Lock symbol. If the latch bolt does not extend to lock, then all codes have been successfully deleted.



## F Disabling and Deleting the Mastercode

1. Keep door open. Press and HOLD the Program button until the Checkmark symbol illuminates (about 5 seconds).

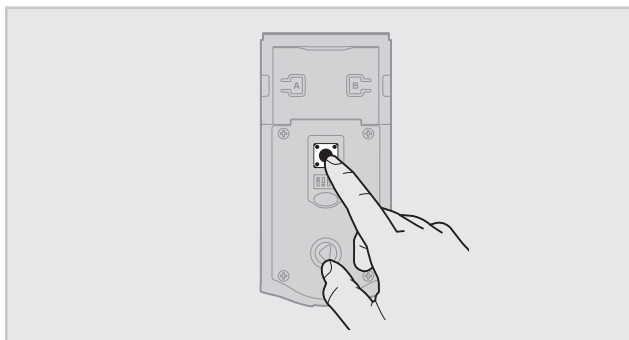

2. Press Checkmark symbol once.

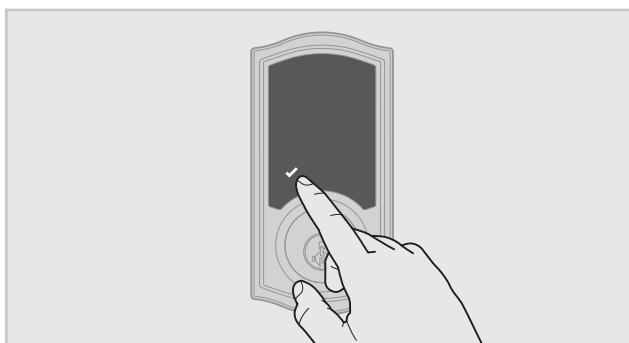

3. Press Lock symbol once.

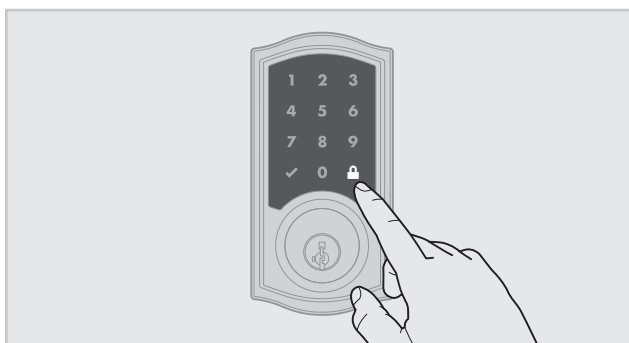

4. Enter Mastercode.

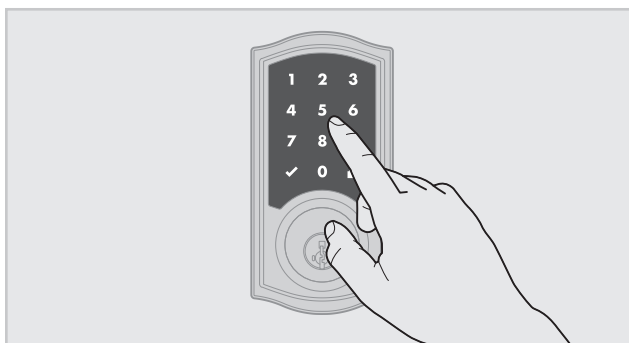

5. Press Lock symbol once.

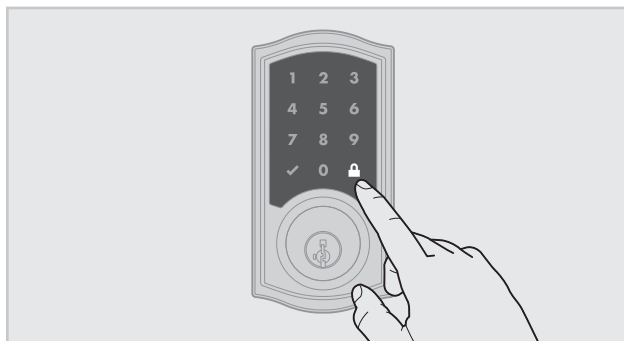

6. Re-enter Mastercode.

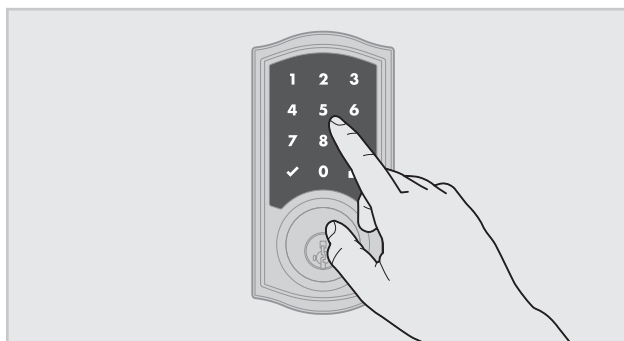

7. Press Lock symbol once.

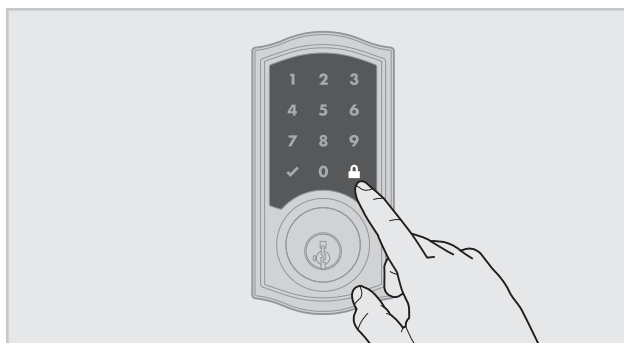

If programming is successful, the Checkmark will illuminate and you will hear one beep.

If programming is unsuccessful, the "X" pattern will flash three times, and you will hear three beeps. Make sure the Mastercode has been enabled before trying to disable it. Attempt the procedure again, making sure to enter the same Mastercode in step 4 and 6.

8. Make sure switch #3 is on, and press the Program button once. If you don't immediately hear five beeps and see the Checkmark flash five times, the Mastercode is disabled.

## 2 Troubleshooting: Installation

- A** The interior mounting screws are difficult to tighten.
- B** The interior and exterior assembly won't mount parallel to the door edge.
- C** The interior assembly does not fit on the mounting plate.

If you encounter any of the problems above, the deadbolt latch may be installed upside down. Remove the interior assembly, mounting plate, and exterior assembly from the door, and look at the latch inside the door hole.

If the word "UP" is upside down and at the bottom of the latch, the latch is installed incorrectly.

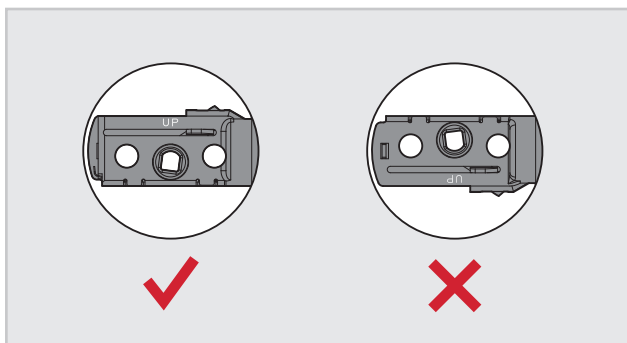

Reinstall the latch, making sure the word "UP" faces upward.

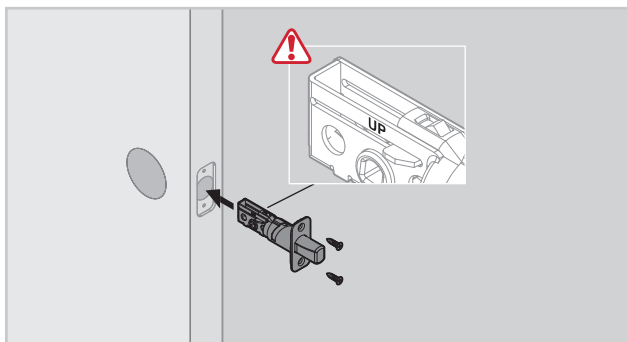

## 3 Troubleshooting: Door Jamming and Door Handing

- A** The lock jams and the turnpiece does not rotate smoothly.
- B** The lock beeps, the Checkmark and Lock symbols alternate flashing, and the door cannot lock.

The door handing process was not executed during installation.

Perform the manual door handing process in the Installation Guide.

The hole in the door is misaligned.

Disassemble the lock, and reinstall it without the adapter ring on the exterior side of the door.

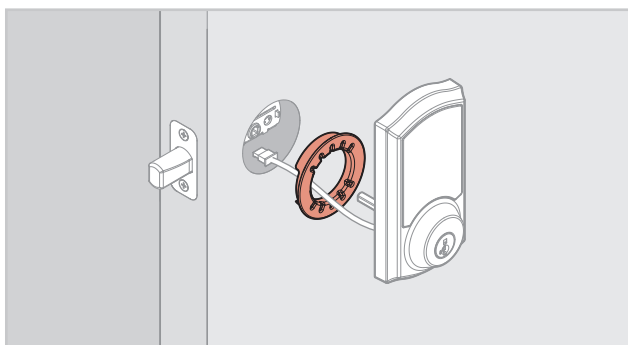

The wrong deadbolt latch is installed.

SmartCode deadbolts require a tapered latch bolt for ease of operation. If the latch being used is from an older lock, it will likely not have a tapered latch bolt. Remove the lock from the door, including the old latch. Replace with the new tapered latch that came with the lock and reinstall the lock.

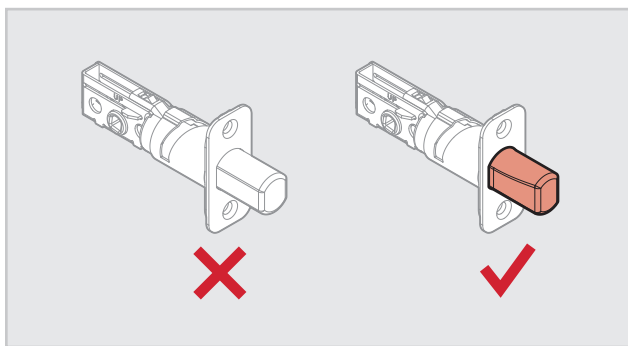

The deadbolt latch and strike are misaligned, causing the latch to bind.

Adjust the tab of the lower strike (for your knob or lever) to help align the upper latch and strike so that the latch bolt enters the strike when the door is locked.

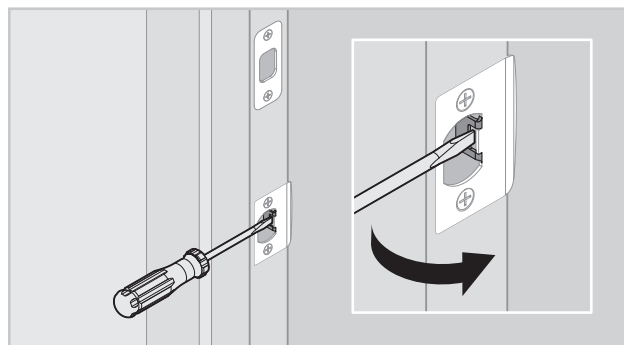

The lower latch and lower strike (for your knob or lever) are misaligned, putting too much load on the deadbolt latch.

As a test, rotate the turnpiece on the deadbolt so the latch is retracted (unlocked), and close the door. If you have to push, pull or lift the door to get it to close, adjust the position of the lower strike.

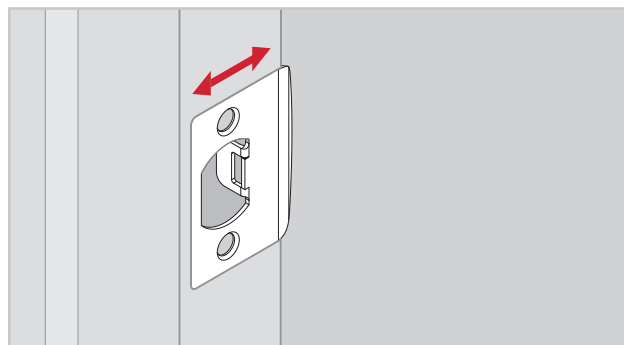

The hole in the door frame for the latch bolt is not drilled deep enough.

Make sure the hole in the door frame is drilled at least 1" (25 mm) deep.

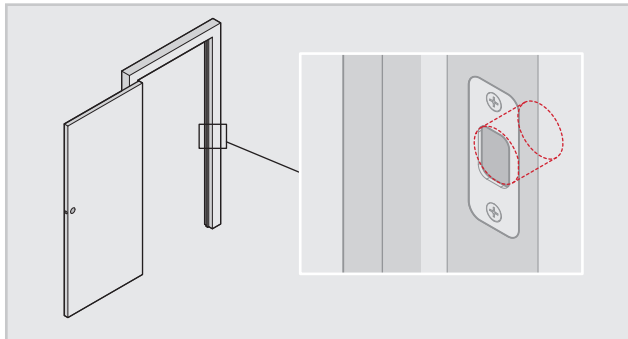

The mounting plate is placing tension on the torque blade.

Attempt to lock and unlock the door with the key. If it is unable to rotate, remove the interior assembly from the mounting plate. Test the key again. If it is still unable to rotate, loosen the screws on the mounting plate and reposition the plate so there is no tension on the cylinder torque blade. Make sure the latch bolt can operate smoothly with the key and reinstall the interior assembly.

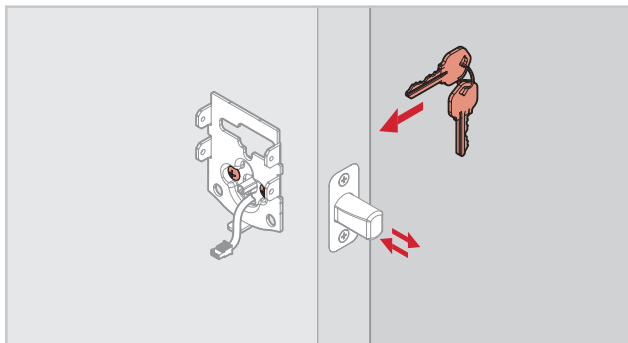

The clutch is disengaged.

Remove the battery pack. Remove the interior assembly from the door. Verify that the lock can be operated smoothly with the key while the interior is removed. Attempt to rotate the turnpiece on the interior assembly to the vertical position. If it cannot rotate to the vertical position, the clutch has become disengaged.

Place the battery cover onto the interior assembly, making sure to align the turnpiece with the shaft. Rotate the turnpiece 180° clockwise (you will need to use force when rotating the turnpiece, and you will hear it click). This will re-engage the clutch.

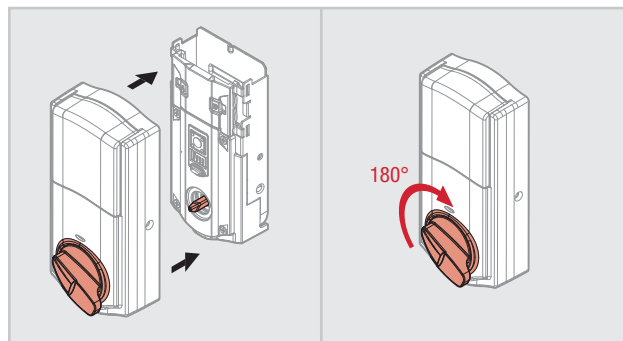

Align the turnpiece with the torque blade and reinstall the interior assembly on the door.

**C The door handing process does not happen automatically when the batteries are installed.**

The handing process may have been executed previously.

Follow the instructions inside the Installation and User Guide to perform the manual door handing process

The battery level is too low.

This is indicated by the Checkmark and Lock symbols flashing simultaneously five times with five beeps. Use a fresh set of batteries, and perform the door handing process again.

**D The touchscreen indicates a failure after the door handing process.**

**E The deadbolt latch does not extend or retract on its own during the door handing process.**

The hole in the door is misaligned.

Disassemble the lock, and reinstall it without the adapter ring on the exterior side of the door.

The mounting plate is placing tension on the torque blade.

See page 12.

The battery level is too low.

This is indicated by the Checkmark and Lock symbols flashing simultaneously five times with five beeps. Use a fresh set of batteries, and perform the manual door handing process.

The latch and strike are misaligned, causing the latch to bind.

Perform the manual door handing process while the door is open. If it is successful only when the door is open, the latch and strike are not aligned as they should be. Ensure door preparation is in accordance with the door drilling instructions, available online.

## 4 Troubleshooting: Touchscreen

### A The touchscreen is unresponsive.

#### Screen activation

To activate the screen, use one of the three options below:

1. Touch screen with palm or back of hand until digits illuminate.
2. Touch lower left area of screen (where Checkmark is located) until digits illuminate.
3. Touch screen with three or more fingers until digits illuminate.

#### One-second pause

The lock requires a one-second pause immediately after locking or unlocking before the touchscreen will re-activate. Fully remove hand from screen until the Checkmark or Lock symbol turns off, and then activate the screen again.

#### Touchscreen lockout

If three incorrect codes were entered within one minute, the touchscreen will lock for 60 seconds.

### B The Lock symbol does not lock the door.

No user codes are programmed.

If there are no codes in the lock, the lock symbol will not lock the door. This is indicated by the "X" pattern flashing three times with three beeps. Program at least one user code and test the Lock symbol again.

The door handing process was not executed.

Perform the manual door handing process, following the instructions inside the Installation and User guide.

The battery is too low to lock the door.

This is indicated by the Checkmark and Lock symbols flashing simultaneously five times with five beeps. Remove the batteries and replace with a fresh set.

The mounting plate is placing tension on the torque blade.

See page 12.

The clutch is disengaged.

See page 12.

### C Only two digits illuminate on the touchscreen.

SecureScreen is enabled.

SecureScreen is an added-security feature that displays random digits before you enter a user code to unlock the door. This feature ensures that there are fingerprints on all digits so that codes cannot be identified by examining the touchscreen for fingerprints.

If desired, this feature can be disabled by turning switch #4 to the off position.

## 5 Troubleshooting: Smart Home Systems

### A The lock fails to pair with a Z-wave smart home system.

The lock was not removed completely from another network before being paired with the new network.

Follow your smart home system's instructions to remove (exclude/unpair) the device from any other network. Then, attempt to pair (add/include) the lock again.

The lock is not close enough to the controller.

Some Z-wave systems require that the lock be within 12" of the controller during the pairing (inclusion/adding) process. If this is the case, remove the lock from the door to perform the pairing process closer to the controller.

**IMPORTANT:** The lock has an anti-tamper alarm that will sound if the interior is disconnect from the exterior while the batteries are installed. Follow steps in order:

- a. Remove the battery pack from the interior assembly.
- b. Remove interior assembly from the mounting plate.
- c. Remove the exterior assembly from the door.
- d. Connect the cable from the exterior assembly to the interior assembly.
- e. Reinstall the battery pack.
- f. Perform the inclusion process while the interior and exterior are connected.

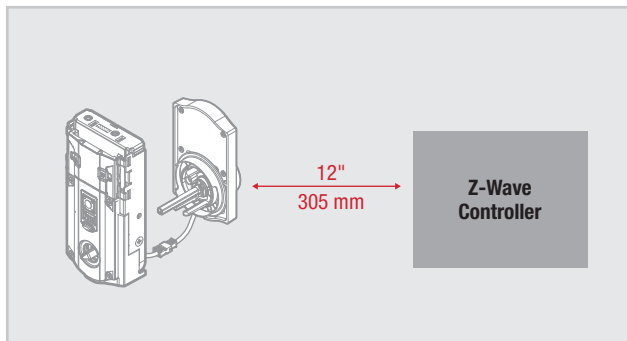

## **B** I can see the lock in my controller, but I can't control it from the controller.

The system needs a repeater or router to reach the lock.

Adding repeaters to your system may help communication between your lock and the controller, especially if they are far away from each other.

The network configuration changed.

If any repeaters or routers in the system were moved since adding the lock to the system, perform the "rediscover" process in your system's user interface.

The lock is in sleep mode.

If the lock has been unable to communicate with the system after multiple attempts, it will go into sleep mode. Lock and unlock the door

with a key so that the lock status transmits to the system. If it still does not communicate, remove (exclude/unpair) the lock from your system. Then, pair (add/include) the lock with your system again. If the problem persists, add a repeater or router between the controller and lock if none presently exist in the system.

The light module or switch is not beaming capable.

Z-Wave locks: Ensure the light module or switch located between the controller and lock is beaming capable.

ZigBee locks: Ensure the router is reachable by both controller and lock.

## **C** The lock fails to update or pair with a service provider's ZigBee smart home system.

Lock fails to OTA (Over the Air) update firmware.

1. Reboot the lock:
  - a. Remove the battery pack from the lock.
  - b. Press the "Program" button for 5 seconds and then the "A" button for 5 seconds.
  - c. If TS (touchscreen controller) shows low battery trouble for the lock subjected to the firmware update then install new batteries in pack.
  - d. Replace the battery pack into the lock.
  - e. If lock still fails to OTA update firmware, proceed to Step 2.
2. Delete, default, and pair lock again:
  - a. Delete the lock from TS (touchscreen controller).
  - b. Perform a factory reset:
    - i. Remove the battery pack from the lock.
    - ii. Press the "Program" button for 5 seconds and then the "A" button for 5 seconds.
  - iii. Press and hold the "Program" button while reinserting the battery pack. Keep holding the button for 30 seconds until the lock beeps and the status LED flashes red.
  - iv. Press the "Program" button momentarily.
  - v. After several seconds, the lock will flash the status LED red and green several times and beeps twice (if audio is enabled) to indicate factory reset is complete.
  - c. For model 910 or 914, perform handing on the lock. For model 916, it will automatically perform handing.
  - d. Pair the lock with TS again.
  - e. If lock still fails to OTA update firmware, proceed to Step 3.
3. If lock still fails to OTA update firmware after going through steps 1 and 2, it is recommended that your MSO/service provider contact Kwikset/Weiser for advanced replacement of the lock.



## 6 Troubleshooting: Battery

### A The batteries drain within one day.

The lock must be replaced. Contact Technical Support.

### B The batteries drain within one week.

The Wireless Card LEDs are staying on.

Remove the battery pack, press and hold the program button for 10 seconds. Replace the battery pack. If the Wireless Card LEDs continue to stay on, contact Technical Support.

### C The batteries drain within a few weeks.

The smart home system's user interface falsely reports a low battery.

If you receive an alert from your smart home system indicating that the battery is low, confirm this is true at the lock. Turn on switch #1 so that the status LED flashes every six seconds. If the LEDs turn amber or green, followed by a red flash, the battery is low. If the red flash is not seen, the battery is not low. This is an error on the smart home system side that will often be fixed when the lock is manually locked or unlocked.

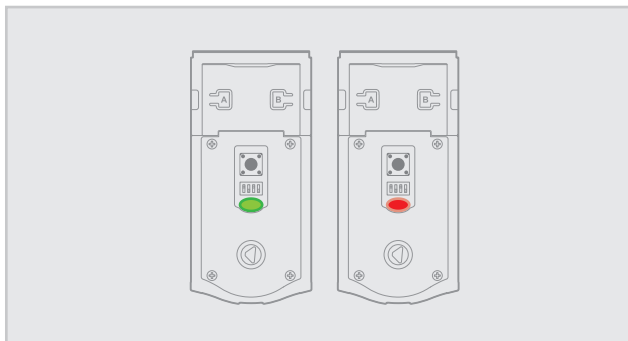

The smart home system controller's communication with the lock is draining the battery.

Remove the lock from your system. Put a new set of batteries in the lock. Operate the lock in stand-alone mode for a week. If the batteries drain within the week, the problem resides in the lock. If the batteries do not drain, the problem may be the smart home controller. Call Technical Support.

The smart home system controller's ping frequency is too high.

Decrease the ping frequency from the controller to the lock to the lowest possible setting.

### D The lock still shows low battery behavior locally and/or on SmartHome console after fresh batteries were installed:

To ensure proper operations post power cycle, allow 30 seconds between battery removal and replacement. If the lock still displays low battery behavior and/or fails to join/rejoin a ZigBee network, remove the battery pack, press and hold the program button for 5 seconds then press and hold button A for 5 seconds. Replace the battery pack.

## 7

## Battery FAQ

How long will the lock operate on a set of batteries?

Based on 10 operations per day, a single, new set of Alkaline batteries will operate the lock for over a year.

What type of batteries do you recommend?

For best results, use new non-rechargeable Alkaline batteries only.

I am planning to be away for several months. Will my lock operate when I get back?

When the system is idling, it consumes minimum power (very close to battery shelf life.) With alkaline batteries, the lock should be operable after years of idle.

I replaced my batteries less than a year ago and need to replace them again.

Check your door alignment. If the deadbolt makes several unsuccessful attempts to lock or unlock the door, it may mean that the door is warped and the latch does not line up correctly with the strike. Operating the lock excessively reduces battery life. Avoid turning on the keypad light unnecessarily.

What settings should I use to get the maximum battery life out of my lock?

Set all switches to the OFF position.