

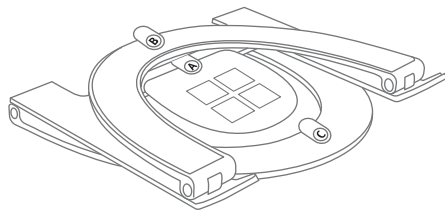

## What's in the Box

- 1** Curve Flex  
(with removable  
Getting Started guide)



- 2** Travel Sleeve  
(with hidden Adjustment Tool  
storage pocket inside)

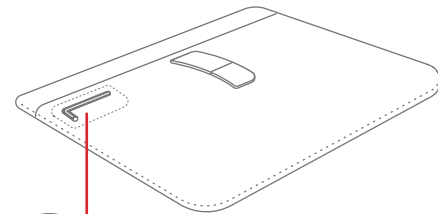

- 3** Adjustment Tool  
(4mm Hex Wrench located  
in Travel Sleeve pocket)

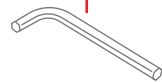

## Adjusting the tension of Curve Flex

Use the included Adjustment Tool to tighten (clockwise) or loosen (counter-clockwise) the four hinges on Curve Flex.

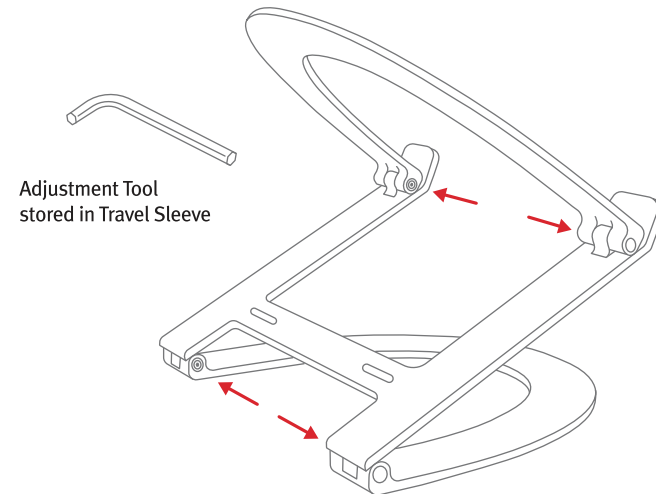

**Curve Flex**  
owner's guide

1 Using Curve Flex

Place Curve Flex on a desk or table.

Raising and adjusting your Curve Flex while it's resting on a table is much easier - and highly recommended.

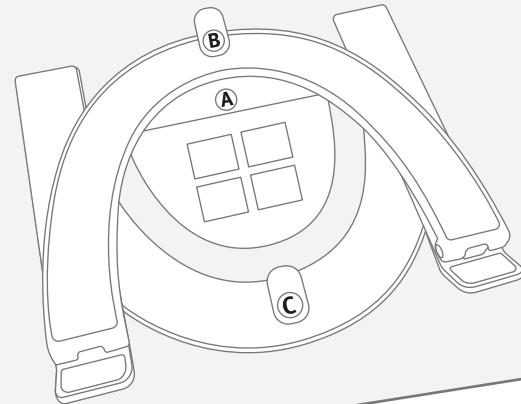

2 Using Curve Flex

Hold **A** down while gently lifting **B** to its maximum height.

Take care not to overextend the front hinges more than 90-degrees.

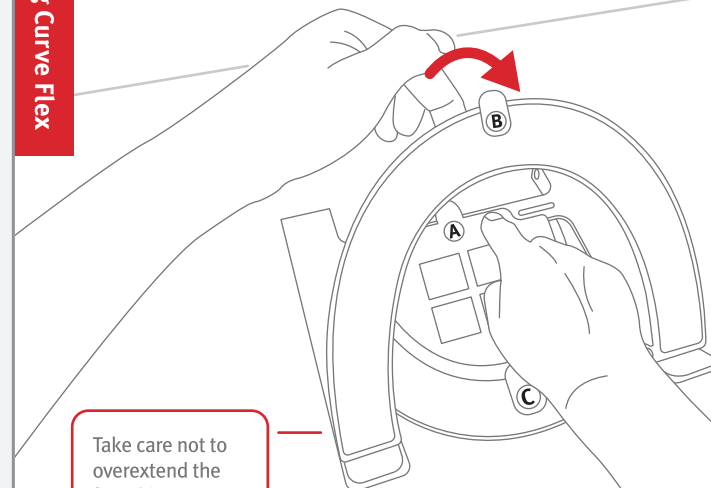

3 Using Curve Flex

Hold **C** down while carefully lifting **B** until you feel it stop.

Notice this opens the back hinges to their max angle of 35-degrees.

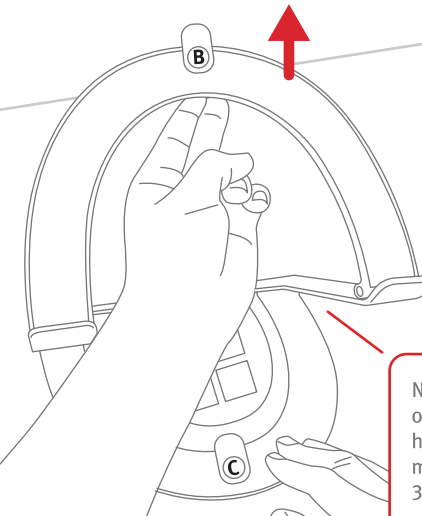

4 Using Curve Flex

Open your MacBook first, *then* place on Curve Flex. To adjust height & angle, hold MacBook and Curve Flex together, then gently press down.

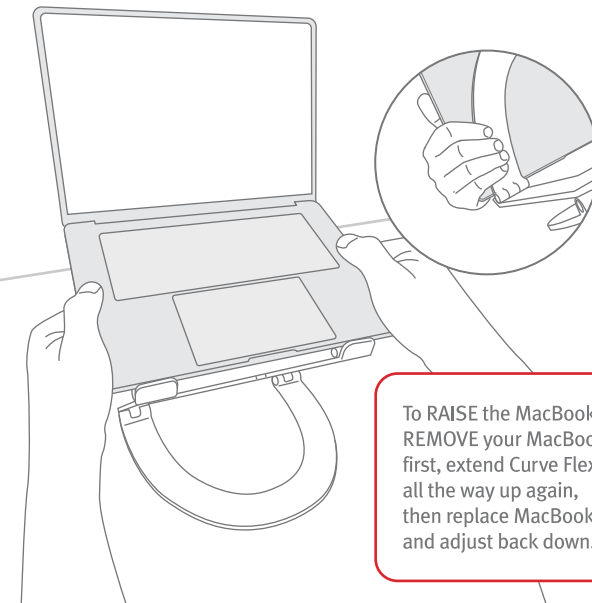

To RAISE the MacBook, REMOVE your MacBook first, extend Curve Flex all the way up again, then replace MacBook and adjust back down.