

INSIGNIA™

20-, 35-, or 50-Pint Dehumidifier

NS-DH20WH1-C/NS-DH35WH1/NS-DH35WH1-C/NS-DH50WH1



Before using your new product, please read these instructions to prevent any damage.

Contents

Introduction	2
IMPORTANT SAFETY INSTRUCTIONS	3
R32 Refrigerant Warning	6
Features	13
Package contents	13
Components	13
Setting up your dehumidifier	15
Preparing your dehumidifier	15
Finding a suitable location	15
Connecting to power	16
Using your dehumidifier	16
Setting the humidity level	16
Auto Start and Auto Stop timers	17
Removing collected water	17
Removing collected water with continuous draining	17
Maintaining your dehumidifier	18
Preparing for maintenance	18
Cleaning the grill and case	18
Cleaning the tank	18
Cleaning the air filter	18
Storing your dehumidifier	19
Troubleshooting	19
Understanding the LED display codes	21
Specifications	21
ONE-YEAR LIMITED WARRANTY	22

Introduction

Congratulations on your purchase of a high-quality Insignia product. Your NS-DH20WH1-C, NS-DH35WH1, NS-DH35WH1-C, or NS-DH50WH1 is a state of the art dehumidifier designed for reliable and trouble-free performance.

IMPORTANT SAFETY INSTRUCTIONS



This symbol indicates that dangerous voltage constituting a risk of electric shock is present within your cooler.



This symbol indicates that there are important operating and maintenance instructions in the literature accompanying your cooler.

WARNING

To reduce the risk of fire, electrical shock, or injury follow these basic precautions when using your dehumidifier.

- 1 Read these instructions.
- 2 Keep these instructions.
- 3 Heed all warnings.
- 4 Follow all instructions.
- 5 Do not exceed the rating of the power outlet or connection device.
- 6 Do not operate or stop the appliance by switching the power supply on or off.
- 7 Do not damage or use an unspecified power cord.
- 8 Do not modify the power cord length or share the outlet with other appliances.
- 9 Do not plug or unplug the AC power cord with wet hands.
- 10 Do not install the appliance in a location that may be exposed to combustible gas.
- 11 Do not place the appliance near a heat source.
- 12 Disconnect the power cord if strange sounds, smells, or smoke come from the appliance.
- 13 Do not try to take apart the appliance or repair it yourself.
- 14 Before cleaning, turn off the power and unplug the appliance.
- 15 Do not use the appliance near flammable gas or combustibles, such as gasoline, benzene, or thinner.
- 16 Do not drink or use the water drained from the appliance.
- 17 Do not remove the water tank during operation.
- 18 Do not use the appliance in small spaces.

- 19 Do not put in places where water may splash onto the appliance.
- 20 Place the appliance on a level, sturdy floor.
- 21 Do not cover the intake or exhaust openings with cloths or towels.
- 22 Care should be taken when using the appliance in a room with infants, children, elderly people, or people sensitive to humidity.
- 23 Do not use in areas where chemicals are handled.
- 24 Never insert your finger or other foreign objects into grills or openings. Take special care to warn children of these dangers.
- 25 Do not place heavy objects on the power cord and make sure that the power cord is not compressed.
- 26 Do not climb up on or sit on the appliance.
- 27 Always insert the filter securely. Clean the filter once every two weeks.
- 28 If water enters the appliance, turn it off and disconnect the power cord, then contact a qualified service technician.
- 29 Do not place flower vases or other items containing water on top of the appliance.
- 30 Do not use an extension cord.

Electrical Information

- 1 The manufacturer's nameplate is located on the rear panel of the appliance and contains electrical and other technical data specific to this appliance.
- 2 Be sure the appliance is properly grounded. To minimize shock and fire hazards, proper grounding is important. The power cord is equipped with a three-prong grounding plug for protection against shock hazards.
- 3 Your appliance must be plugged into a properly grounded wall receptacle. If the wall receptacle you intend to use is not adequately grounded or protected by a time delay fuse or circuit breaker (please refer to the nameplate for the electrical data), have a qualified electrician install a proper receptacle.

Cautions

- 1 This appliance can be used by children aged eight years and above and persons with reduced physical, sensory, or mental capabilities, or lack of experience and knowledge. Make sure that they have been given supervision or instruction concerning the use of the appliance in a safe way and understand the hazards involved. Children should not play with the appliance. Children should not clean or maintain the appliance without supervision. (applicable in European Countries)
- 2 This appliance is not intended for use by persons (including children) with reduced physical, sensory or mental capabilities or lack of experience and knowledge, unless they have been given supervision or instruction concerning use of the appliance by a person responsible for their safety. Children should be supervised to ensure that they do not play with the appliance (applicable except in European Countries).
- 3 If the supply cord is damaged, it must be replaced by the manufacturer, its service agent, or similarly qualified persons, in order to avoid a hazard.

- 4 Prior to cleaning or other maintenance, the appliance must be unplugged.
- 5 Do not install the appliance in a location that may be exposed to combustible gas. If combustible gas accumulates around the appliance, it may cause fire.
- 6 If the appliance is knocked over during use, turn it off and unplug it immediately. Visually inspect the appliance to ensure that there is no damage. If you suspect the appliance has been damaged, contact a technician or customer service for assistance.
- 7 Unplug the appliance in a thunderstorm to avoid damage due to lightning.
- 8 Do not run the electrical cord under carpeting. Do not cover the cord with throw rugs, runners, or similar coverings. Do not route the cord under furniture or appliances. Arrange the cord away from traffic areas and where it will not be tripped over.
- 9 Do not operate this appliance with a damaged power cord or plug. If the power cord or plug is damaged, discard the appliance or return it to an authorized service facility for examination and/or repair.
- 10 To reduce the risk of fire or electric shock, do not use this appliance with any solid-state speed control device.
- 11 The appliance shall be installed in accordance with national wiring regulations.
- 12 Contact an authorized service technician for repair or maintenance of this appliance.
- 13 Turn off the appliance when not in use.

SAVE THESE INSTRUCTIONS

Note: All of the illustrations in this manual are for explanation purposes only. Your dehumidifier may look slightly different than those depicted here. The actual shape is appropriate. The design and specifications are subject to change without prior notice for product improvement. Consult with the store or manufacturer for details. Any updates to the manual will be uploaded to the service website, please check for the latest version.

A note about fluorinated gases

- 1 Fluorinated greenhouse gases are contained in hermetically sealed equipment. For specific information on the type, the amount, and the CO² equivalent, in tons of the fluorinated greenhouse gas (on some models), please refer to the relevant label on the appliance itself.
- 2 Installation, service, maintenance, and repair of this appliance must be performed by a certified technician.
- 3 Product disassembly and recycling must be performed by a certified technician.

R32 Refrigerant Warning



CAUTION:
Risk of fire
flammable materials

IMPORTANT NOTE: Read this manual carefully before installing or operating your new air conditioning unit. Make sure to save this manual for future reference.

Explanation of symbols displayed on the unit

	CAUTION	This symbol shows that the operation manual should be read carefully.
	CAUTION	This symbol shows that a service personnel should be handling this equipment with reference to the installation manual.
	CAUTION	This symbol shows that information is available such as the operating manual or installation manual.

- Servicing shall only be performed as recommended by the equipment manufacturer. Maintenance and repair requiring the assistance of other skilled personnel shall be carried out under the supervision of a person competent in the use of flammable refrigerants.
- DO NOT modify the length of the power cord or use an extension cord to power the unit.
- DO NOT share a single outlet with other electrical appliances. Improper power supply can cause fire or electrical shock.
- Please follow the instructions carefully to handle, install, clear, or service the dehumidifier to avoid any damage or hazard.
- Flammable Refrigerant R32 is used within this dehumidifier.
- When maintaining or disposing of this dehumidifier, the refrigerant (R32) shall be recovered properly and shall not be discharged directly into the air.
- Compliance with national gas regulations shall be observed.
- Keep ventilation openings clear of obstruction.
- The appliance shall be stored so as to prevent mechanical damage from occurring.
- This appliance shall be stored in a well-ventilated area where the room size corresponds to the room area specified for its operation.
- Any person who is involved with working on or breaking into a refrigerant circuit should hold a current valid certificate from an industry-accredited assessment authority, which authorizes their competence to handle refrigerants safely and in accordance with an industry recognized assessment specification. Examples of such working procedures are:
 - Breaking into the refrigerating circuit.
 - Opening of sealed components.
 - Opening of ventilated enclosures.

- This dehumidifier should not be placed near any open fire or device which may generate sparks or arcing, to avoid causing ignition of the flammable refrigerant used. Please follow the instruction carefully to store or maintain this dehumidifier to prevent mechanical damage from occurring.
- The appliance shall not be stored in a room with continuously operating ignition sources (such as open flames, operating gas appliance, or electric heaters) close to the appliance.
- Do not pierce the refrigerant circuit or burn anything near this dehumidifier.
- Be aware that the refrigerant may not contain an odor.

AVERTISSEMENT

Ne pas utiliser de produits permettant d'accélérer le dégel ou de produits de nettoyage autres que ceux recommandés par le fabricant.

L'appareil doit être entreposé dans un endroit sans source d'allumage fonctionnant en continu (par exemple : flamme nue, appareil au gaz en marche ou radiateur électrique en marche).

Ne pas percer ni brûler. Attention : les frigorigènes peuvent être inodores.

Transport of equipment containing flammable refrigerants.

See transport regulations.

Marking of equipment using signs

See local regulations.

Disposal of equipment using flammable refrigerants

See national regulations.

Storage of equipment/appliances

The storage of equipment should be in accordance with the manufacturer's instructions.

Storage of packed (unsold) equipment

Storage package protection should be constructed such that mechanical damage to the equipment inside the package will not cause a leak of the refrigerant charge. The maximum number of pieces of equipment permitted to be stored together will be determined by local regulations.

Information on servicing

1 Checks to the area

Prior to beginning work on systems containing flammable refrigerants, safety checks are necessary to ensure that the risk of ignition is minimized. For repair to this dehumidifier, the following precautions shall be complied with prior to conducting work on the system.

2 Work procedure

Work shall be undertaken under a controlled procedure so as to minimize the risk of a flammable gas or vapor being present while the work is being performed.

3 General work area

All maintenance staff and others working in the local area shall be instructed on the nature of work being carried out. Work in confined spaces shall be avoided. The area around the workspace shall be sectioned off. Make sure that the conditions within the area have been made safe by control of flammable material.

4 Checking for presence of refrigerant

The area shall be checked with an appropriate refrigerant detector prior to and during work, to ensure that the technician is aware of potentially flammable gases. Make sure that the leak detection equipment being used is suitable for use with flammable refrigerants, and are non-sparking, adequately sealed, or intrinsically safe.

5 Presence of fire extinguisher

If any hot work is to be conducted on the refrigeration equipment or any associated parts, appropriate fire extinguishing equipment shall be readily available. Have a dry powder or CO2 fire extinguisher adjacent to the charging area.

6 No ignition sources

No person carrying out work in relation to a refrigerating system which involves exposing any pipe work that contains or has contained flammable refrigerant shall use any sources of ignition in such a manner that it may lead to the risk of fire or explosion. All possible ignition sources, including cigarette smoking, should be kept sufficiently far away from the site of installation, repairing, removing and disposal, during which flammable refrigerant can possibly be released to the surrounding space. Prior to work taking place, the area around the equipment is to be surveyed to make sure that there are no flammable hazards or ignition risks. No Smoking signs shall be displayed.

7 Ventilated area

Make sure that the area is in the open or that it is adequately ventilated before breaking into the system or conducting any hot work. A degree of ventilation shall continue during the period that the work is carried out. The ventilation should safely disperse any released refrigerant and preferably expel it externally into the atmosphere.

8 Checks to the refrigerating equipment

Where electrical components are being changed, they shall be fit for the purpose and to the correct specifications. The manufacturer's maintenance and service guidelines shall be followed at all times. If in doubt, consult the manufacturer's technical department for assistance.

The following checks shall be applied to installations using flammable refrigerants:

- The actual refrigerant charge is in accordance with the room size within which the refrigerant containing parts are installed.
- The ventilation machinery and outlets are operating adequately and are not obstructed.
- If an indirect refrigerating circuit is being used, the secondary circuit shall be checked for the presence of refrigerant.
- Marking to the equipment continues to be visible and legible. Markings and signs that are illegible shall be corrected.

- Refrigerating pipe or components are installed in a position where they are unlikely to be exposed to any substance which may corrode refrigerant containing components, unless the components are constructed of materials which are inherently resistant to being corroded or are suitably protected against being so corroded.
- 9 Checks to electrical devices
- Repair and maintenance to electrical components shall include initial safety checks and component inspection procedures. If a fault exists that could compromise safety, no electrical supply shall be connected to the circuit until it is satisfactorily dealt with. If the fault cannot be corrected immediately but it is necessary to continue operation, an adequate temporary solution shall be used. This shall be reported to the owner of the equipment so all parties are advised.
- Initial safety checks shall include:
- That capacitors are discharged: this shall be done in a safe manner to avoid possibility of sparking.
 - That there are no live electrical components or wiring exposed while charging, recovering, or purging the system;
 - That there is continuity of earth bonding.

Repairs to sealed components

- 1 During repairs to sealed components, all electrical supplies shall be disconnected from the equipment being worked upon prior to any removal of sealed covers, etc. If it is absolutely necessary to have an electrical supply to equipment during servicing, then a permanently operating form of leak detection shall be located at the most critical point to warn of a potentially hazardous situation.
- 2 Particular attention shall be paid to the following to ensure that by working on electrical components, the casing is not altered in such a way that the level of protection is affected:
 - This shall include damage to cables, excessive number of connections, terminals not made to original specification, damage to seals, incorrect fitting of glands, etc.
 - Make sure that the apparatus is mounted securely.
 - Make sure that seals or sealing materials have not degraded such that they no longer serve the purpose of preventing the ingress of flammable atmospheres.
 - Replacement parts shall be in accordance with the manufacturer's specifications.

NOTE: The use of silicon sealant may inhibit the effectiveness of some types of leak detection equipment. Intrinsically safe components do not have to be isolated prior to working on them.

Repair to intrinsically safe components

Do not apply any permanent inductive or capacitance loads to the circuit without ensuring that this will not exceed the permissible voltage and current permitted for the equipment in use. Intrinsically safe components are the only types that can be worked on while live in the presence of a flammable atmosphere. The test apparatus shall be at the correct rating. Replace components only with parts specified by the manufacturer. Other parts may result in the ignition of refrigerant in the atmosphere from a leak.

Cabling

Make sure that cabling will not be subject to wear, corrosion, excessive pressure, vibration, sharp edges, or any other adverse environmental effects. The check shall also take into account the effects of aging or continual vibration from sources such as compressors or fans.

Detection of flammable refrigerants

Under no circumstances shall potential sources of ignition be used in the searching for or detection of refrigerant leaks. A halide torch (or any other detector using a naked flame) shall not be used.

The following leak detection methods are deemed acceptable for systems containing flammable refrigerants:

- Electronic leak detectors shall be used to detect flammable refrigerants, but the sensitivity may not be adequate, or may need re-calibration. (Detection equipment shall be calibrated in a refrigerant-free area). Ensure that the detector is not a potential source of ignition and is suitable for the refrigerant used.
- Leak detection equipment shall be set at a percentage of the LFL of the refrigerant and shall be calibrated to the refrigerant employed and the appropriate percentage of gas (25% maximum) is confirmed.
- Leak detection fluids are suitable for use with most refrigerants but the use of detergents containing chlorine shall be avoided as the chlorine may react with the refrigerant and corrode the copper pipe-work. If a leak is suspected, all naked flames shall be removed/extinguished.

If a leakage of refrigerant is found which requires brazing, all of the refrigerant shall be recovered from the system, or isolated (by means of shut off valves) in a part of the system remote from the leak. Removal of refrigerant shall be according to Removal and evacuation.

Removal and evacuation

When breaking into the refrigerant circuit to make repairs – or for any other purpose–conventional procedures shall be used. However, for flammable refrigerants it is important that best practices be followed, since flammability is a consideration. The following procedure shall be adhered to:

- 1 Safely remove refrigerant following local and national regulations.
- 2 Purge the circuit with inert gas.
- 3 Evacuate (optional for A2L).
- 4 Purge with inert gas (optional for A2L).
- 5 Open the circuit by cutting or brazing.
- 6 The refrigerant charge shall be recovered into the correct recovery cylinders if venting is not allowed by local and national codes.
 - For appliances containing flammable refrigerants, the system shall be purged with oxygen-free nitrogen to render the appliance safe for flammable refrigerants. This process might need to be repeated several times.
 - Compressed air or oxygen shall not be used for purging refrigerant systems.
 - For appliances containing flammable refrigerants, refrigerants purging shall be achieved by breaking the vacuum in the system with oxygen-free nitrogen and continuing to fill until the working pressure is achieved, then

venting to atmosphere, and finally pulling down to a vacuum (optional for A2L). This process shall be repeated until no refrigerant is within the system (optional for A2L).

- When the final oxygen-free nitrogen charge is used, the system shall be vented down to atmospheric pressure to enable work to take place. Ensure that the outlet for the vacuum pump is not close to any potential ignition sources and that ventilation is available.

Charging procedures

In addition to conventional charging procedures, the following requirements shall be followed:

- Ensure that contamination of different refrigerants does not occur when using charging equipment.
- Hoses or lines shall be as short as possible to minimize the amount of refrigerant contained in them.
- Cylinders shall be kept in an appropriate position according to the instructions.
- Ensure that the refrigeration system is earthed prior to charging the system with refrigerant.
- Label the system when charging is complete (if not already).
- Extreme care shall be taken not to overfill the refrigeration system.
- Prior to recharging the system it shall be pressure tested with OFN.
- The system shall be leak tested on completion of charging but prior to commissioning.
- A follow up leak test shall be carried out prior to leaving the site.

Decommissioning

Before carrying out this procedure, it is essential that the technician is completely familiar with the equipment and all its detail. It is recommended good practice that all refrigerants be recovered safely. Prior to the task being carried out, an oil and refrigerant sample shall be taken in case analysis is required prior to re-use of reclaimed refrigerant. It is essential that electrical power is available before the task is commenced.

- 1 Become familiar with the equipment and its operation.
- 2 Isolate the system electrically.
- 3 Before attempting the procedure, make sure that:
 - Mechanical handling equipment is available, if required, for handling refrigerant cylinders.
 - All personal protective equipment is available and being used correctly.
 - The recovery process is supervised at all times by a competent person.
 - Recovery equipment and cylinders conform to the appropriate standards.
- 4 Pump down refrigerant system, if possible. If a vacuum is not possible, make a manifold so that refrigerant can be removed from various parts of the system.
- 5 Make sure that the cylinder is situated on the scales before recovery takes place.
- 6 Start the recovery machine and operate it in accordance with instructions.
 - Do not overfill cylinders. (No more than 80% volume liquid charge).
 - Do not exceed the maximum working pressure of the cylinder, even temporarily.

- 7 When the cylinders have been filled correctly and the process completed, make sure that the cylinders and the equipment are removed from the site promptly and all isolation valves on the equipment are closed.
- 8 Recovered refrigerant shall not be charged into another refrigeration system unless it has been cleaned and checked.

Labeling

Equipment shall be labeled stating that it has been decommissioned and emptied of refrigerant. The label shall be dated and signed. Make sure that there are labels on the equipment stating the equipment contains flammable refrigerant.

Recovery

When removing refrigerant from a system, either for servicing or decommissioning, it is a recommended good practice that all refrigerants are removed safely. When transferring refrigerant into cylinders, make sure that only appropriate refrigerant recovery cylinders are employed. Make sure that the correct number of cylinders for holding the total system charge are available. All cylinders to be used are designated for the recovered refrigerant and labeled for that refrigerant (i.e. special cylinders for the recovery of refrigerant). Cylinders shall be complete with pressure relief valve and associated shut-off valves in good working order. Empty recovery cylinders are evacuated and, if possible, cooled before recovery occurs.

The recovery equipment shall be in good working order with a set of instructions concerning the equipment that is at hand and shall be suitable for the recovery of flammable refrigerants. In addition, a set of calibrated weighing scales shall be available and in good working order. Hoses shall be complete with leak-free disconnect couplings and in good condition. Before using the recovery machine, check that it is in satisfactory working order, has been properly maintained, and that any associated electrical components are sealed to prevent ignition in the event of a refrigerant release. Consult manufacturer if in doubt. The recovered refrigerant shall be returned to the refrigerant supplier in the correct recovery cylinder, and the relevant Waste Transfer Note arranged.

Do not mix refrigerants in recovery units and especially not in cylinders. If compressors or compressor oils are to be removed, make sure that they have been evacuated to an acceptable level to make certain that flammable refrigerant does not remain within the lubricant. The evacuation process shall be carried out prior to returning the compressor to the suppliers. Only electric heating to the compressor body shall be employed to accelerate this process. When oil is drained from a system, it shall be carried out safely.

Non-duct connected appliances containing A2L refrigerants, with the supply and return air openings in the conditioned space, may have the body of the appliance installed in open areas, such as false ceilings not being used as return air plenums, as long as the conditioned air does not directly communicate with the air of the false ceiling.

Features

- Maintains a comfortable relative humidity level
- Capable of removing 20, 35, or 50 pints of water out of the air each day (depending on model)
- 20 pt. - 3.2 qt. (3 liter) tank
- 35/50 pt. - 6.3 qt. (6 liter) tank
- Automatically turns off when the tank is full
- Adjustable humidistat for complete control
- Portable design with caster wheels for easy movement and placement
- EnergyStar certified

Package contents



Dehumidifier



User Guide

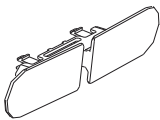

Power cord bracket

Components

Front and back

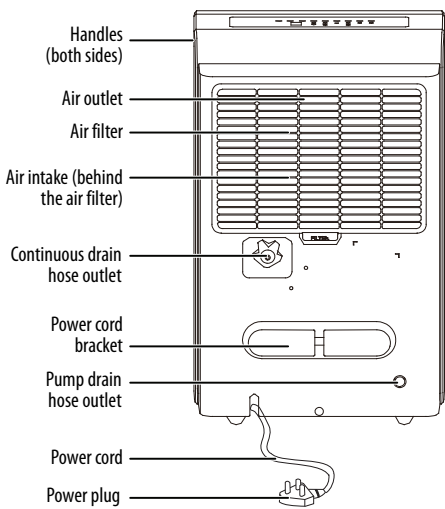
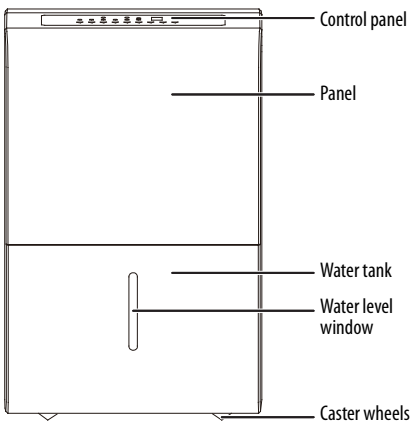

Control panel

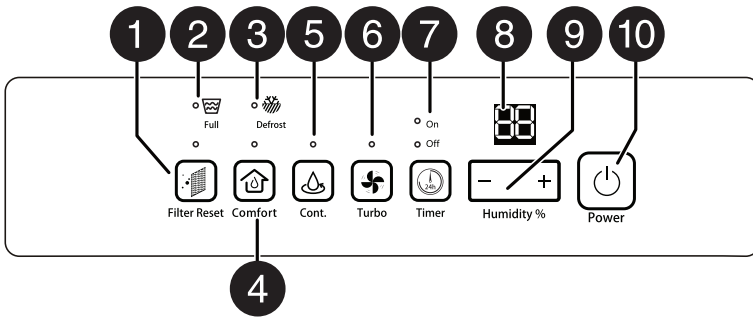

#	FEATURE	FUNCTION
1	Filter Reset	The filter light flashes after 250 hours of operation, indicating that the air filter needs to be cleaned. To reset the light after cleaning the filter, press the FILTER button.
2	Full	Turns on when the water tank is full. Turn off the unit and empty the water tank.
3	(Auto) Defrost	Turns on when the dehumidifier is in auto defrost mode. The fan continues to run in this mode.
4	Comfort	Press to set the dehumidifier to the comfort setting (humidity is set to a preset level). The indicator LED turns on. The dehumidifier senses the temperature in the room and automatically adjusts the humidity to 45–55% for the optimal comfort. The length time the dehumidifier is on will vary, depending on ambient humidity and temperature. Press again or adjust the humidity level to turn off the comfort setting. The indicator LED turns off.
5	Cont. (Continuous dehumidifying)	Press to turn on continuous dehumidifying. The indicator LED turns on. Press again to turn off continuous dehumidifying. The indicator LED turns off.
6	Turbo	Press to set the fan speed to high. The indicator LED turns on. Press again to set the fan speed to normal. The indicator LED turns off.
7	Timer	Press to initiate the Auto Start and Auto Stop programs. See Auto Start and Auto Stop timers on page 17.
8	LED Display	Normally displays the actual room relative humidity level (from 30% to 90%). When setting the desired humidity level, displays the setting level from 35% to 85%. When setting the auto start/stop time, displays the time (0~24 hours).
9	Humidity % +/- buttons	Use to set the desired humidity level from 35% to 85% (in 5% increments). When auto start/stop mode is initiated, press to set the time until auto start is initiated, then press to set the duration until auto stop turns the unit off.
10	Power	Press to turn the power on or off.

Notes:

- Touch the control panel lightly when pressing the keys.
- To avoid scratching the control panel, do not touch it with sharp objects.

Setting up your dehumidifier

Preparing your dehumidifier

- Remove the exterior and interior packing.
- Clean the exterior surface with lukewarm water using a soft cloth.

Finding a suitable location

Note: Your dehumidifier is more efficient when in a closed room, but it can be used in a room with the doors open to dehumidify a larger area.

- This dehumidifier is designed to be free standing.
- Place your dehumidifier on a solid floor that is strong enough to support it when the water tank is full.
- The working environment should be between 41° F (5° C) and 90° F (32° C).
- Locate the dehumidifier away from direct sunlight and sources of heat (stove, heater, radiator, and so on). Direct sunlight may affect the acrylic coating and heat sources may increase electrical consumption. Ambient temperature below 41° F (5° C) and above 90° F (32° C) will hinder the performance of this appliance.

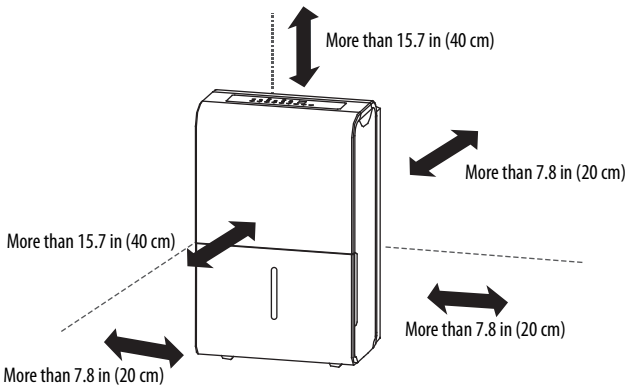
**CAUTION:**

- Do not force the casters to move over carpet.
- Do not move the dehumidifier with water in the tank. It may tip over and spill the contents.

Connecting to power

- Plug your dehumidifier into a dedicated, properly installed, grounded wall outlet. This appliance should be operated on a separate electrical circuit from other operating appliances. Do not, under any circumstances, cut or remove the third (ground) prong from the power cord. Any questions concerning power and/or grounding should be directed toward a certified electrician or an authorized service center.
- Do not use an extension cord with this dehumidifier. If the power cord is too short, have a qualified electrician install an outlet near the appliance. Use of an extension cord can negatively affect the dehumidifier's performance.
- Remove the power cord storage bracket from your dehumidifier's water tank (on the front), then insert the power cord storage bracket into the back of your dehumidifier. The power cord storage bracket will click into place.

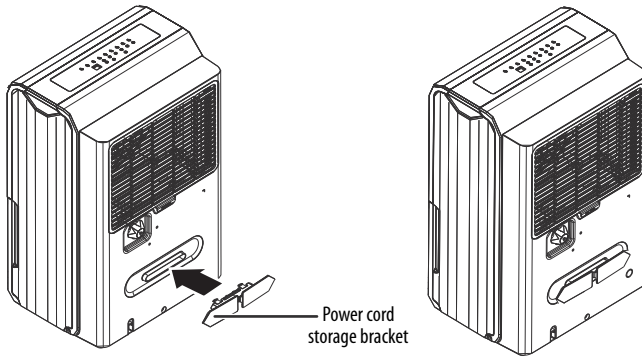

Using your dehumidifier

- 1 Plug your dehumidifier's power plug into a power outlet.
- 2 Press the **POWER** button, then set your dehumidifier to the desired humidity level.

Notes:

- When the set humidity level is reached, the dehumidifier turns off automatically.
- When the dehumidifier is turned off, it cannot be restarted again for three minutes.
- When frost builds up on the evaporator coils, the compressor cycles off and the fan continues to run until the frost is eliminated.
- If the dehumidifier is turned off due to a power outage, it automatically restarts when the power is restored.

Setting the humidity level

- 1 For drier air, press the ◀ button to set a lower humidity level.
- 2 For damper air, press the ▶ button to set a higher humidity level.

Note: The humidity level can be set to from 35–85% relative humidity, in increments of 5%.

Auto Start and Auto Stop timers

Your dehumidifier has the option to set a timer to turn it on and/or to turn it off. When you set the Auto Start or Auto Stop timers, the On or Off LED indicators light to remind you which timer has been set. When both the Auto Start and Auto Stop times are set in the same sequence, both the On and Off indicator lights remain lit.

Notes:

- The timer settings are for one-time only and will need to be set each time you want your dehumidifier to turn on and off by itself.
- You do not have to use the Auto Start and Auto Stop timers together. You can set one or the other.
- Turning your dehumidifier on or off at any time or adjusting the timer setting to 0.0 will cancel the timer function.
- If the LED display shows P2, the timer function is canceled. The P2 error code displays when the water tank is full or is not in the right position.

Setting the Auto Start timer

- 1 Press **TIMER** until the On indicator LED turns on.
- 2 Press and hold the ◀ or ▶ buttons to select the number of hours before your dehumidifier will automatically turn on, then wait for the LED display to return to its previous state. The setting is saved.

Note: The ◀ or ▶ buttons increment by 0.5 hours up to 10 hours. After you reach 10, the ◀ or ▶ buttons increment by 1 hour up to 24 hours.

Setting the Auto Stop timer

- 1 Press **TIMER** until the Off indicator LED turns on.
- 2 Press and hold the ◀ or ▶ buttons to select the number of hours before your dehumidifier will automatically turn off, then wait for the LED display to return to its previous state. The setting is saved.

Notes:

- The ◀ or ▶ buttons increment by 0.5 hours up to 10 hours. After you reach 10, the ◀ or ▶ buttons increment by 1 hour up to 24 hours.

Removing collected water

- 1 When the **Full** indicator lights, remove the tank from your dehumidifier.
- 2 Pour the water out, then reinsert the tank into your dehumidifier.

Notes:

- When the tank is full, your dehumidifier automatically turns off and the Full indicator lights.
- Your dehumidifier will automatically restart when the tank is back in place.
- If you remove the tank while your dehumidifier is running, the LED display shows "P2" and your dehumidifier stops running.

Removing collected water with continuous draining

- 1 Remove the plastic cover from the continuous drain hose outlet.

- 2 Screw a 5/16" drain hose (not included) onto the female threaded end of the continuous drain hose outlet.

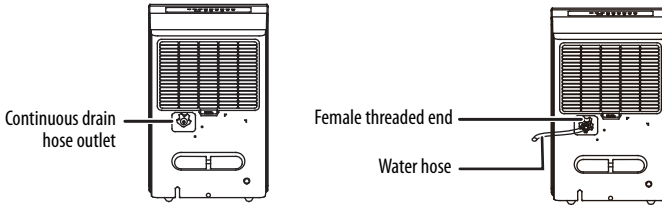

- 3 Direct the hose towards a floor drain.

Note: Make sure there are no kinks in the hose, as they may stop collected water from draining.

Maintaining your dehumidifier

Preparing for maintenance

- 1 Turn your dehumidifier off.
- 2 Disconnect your dehumidifier's plug from the power supply.

Cleaning the grill and case

- 1 Use water and a mild detergent to clean the grill and case.
- 2 Use a vacuum cleaner or brush to clean the air intake.

Note: Do not splash water directly onto your dehumidifier. Doing so may cause an electrical shock, deterioration of the insulation, or rust.

Cleaning the tank

- 1 Remove the tank from your dehumidifier, then fill the tank with water and a mild detergent.
- 2 Swish the water and detergent around in the tank, then empty and rinse the tank.
- 3 Let the tank air dry or dry it with a cloth, then place it back into your dehumidifier.

Notes:

- Clean the tank every few weeks to prevent growth of mold, mildew, and bacteria.
- Do not use a dishwasher to clean the tank.

Cleaning the air filter

The air filter should be cleaned after 250 hours of use or 30 days, whichever comes first. The **FILTER** LED indicator lights up after 250 hours of use to indicate when to clean the filter.

- 1 Remove the air filter by pulling it outwards.

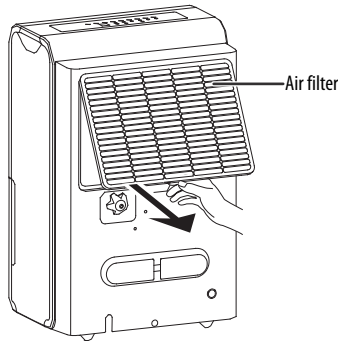

- 2 Wash the filter with water, then let it air dry.
- 3 Reinstall the filter, then press **Filter Reset**.

CAUTION: Do not use your dehumidifier without a filter. Doing so may allow dirt and lint to damage your dehumidifier.

Storing your dehumidifier

- 1 Before storing, let your dehumidifier rest for one full day so that it can air dry, then empty the water tank.
- 2 Clean the grill, case, tank, and air filter.
- 3 Wrap the power cord around the power cord buckle.
- 4 Cover your dehumidifier with a plastic bag.
- 5 Store the unit upright in a dry, well-ventilated area.

Troubleshooting

PROBLEM	SOLUTION
My dehumidifier does not start	<ul style="list-style-type: none"> • Make sure that your dehumidifier is plugged in. • Make sure that the water tank is in the proper position. • Check if the water tank is full. • Check if your dehumidifier has reached your set humidity level. • Check the house fuse/circuit breaker box.

PROBLEM	SOLUTION
My dehumidifier does not dry the air as it should	<ul style="list-style-type: none"> • Make sure that you have allowed your dehumidifier enough time to remove moisture from the air. • Make sure that there are no curtains, blinds, or furniture blocking the front or back of the dehumidifier. • Lower the humidity level. • Make sure that all doors, windows, and other openings are closed. • Make sure that the room's temperature is not below 41° F (5° C). • Make sure that there isn't a water vapor source in your room.
My dehumidifier makes a loud noise when operating	<ul style="list-style-type: none"> • Make sure that the air filter is not dirty. If it is, clean the air filter. • Make sure that your dehumidifier is upright and is placed on a level floor. • Your dehumidifier may sound loud for the first two or three minutes of operation while the compressor starts up.
My dehumidifier makes a soft, swishing noise when operating	<ul style="list-style-type: none"> • This is normal. Your dehumidifier has liquid refrigerant flowing inside of it.
My dehumidifier makes a gurgling noise when operating	<ul style="list-style-type: none"> • Make sure that your dehumidifier is upright and is placed on a level floor.
Frost appears on my dehumidifier's coils	<ul style="list-style-type: none"> • This is normal. Your dehumidifier has an auto defrost feature that starts when too much frost buildup occurs.
There is water on my floor	<ul style="list-style-type: none"> • If you are using the water tank, make sure that the back drain plug is in place. • If you are using the drain hose, make sure that the hose is connected securely to your dehumidifier.
The LED display shows ES, AS, P2, or Eb	<ul style="list-style-type: none"> • These are error and protection codes. See Understanding the LED display codes below.

Understanding the LED display codes

CODE	MEANING
Error	
AS	Humidity sensor error. Unplug your dehumidifier and plug it back in. If the error persists, contact Customer Service.
ES	Evaporator tube temperature sensor error. Unplug your dehumidifier and plug it back in. If the error persists, contact Customer Service.
Eb	The water tank has been removed or is not in the correct position. Replace the tank in the correct position. This code only displays on units with the pump feature.
Protection	
P2	The water tank is full or is not in the correct position. Empty the tank or place it in the correct position. On units with pump feature - The water tank is full and needs to be emptied.

Note: When the AS or ED error code is displayed, turn off the unit and check for any obstructions, then restart the unit. If the error code returns, turn off the unit and unplug the power cord. Contact the manufacturer or its service agents or a similar qualified person for service.

Specifications

Dimensions (W × D × H)	20 pt. - 16.1 x 10.7 x 19.7 in. (41 x 27.3 x 50 cm) 35 and 50 pt. - 16.8 x 11.7 x 24.4 in. (42.7 x 29.8 x 62 cm)
Weight	20 pt. - Net = 33 lb. (15 kg) Gross = 36.8 lb. (16.7 kg) 35 pt. - Net = 39.8 lb. (18.06 kg) Gross = 44.6 lb. (20.22 kg) 50 pt. - Net = 41.4 lb. (18.77 kg) Gross = 46.2 lb. (20.94 kg)
Power requirements	115V~60Hz
Power consumption	20 pt. - 270W 35 pt. - 380W 50 pt. - 545W
Power cord length	6.2 ft. (1.9 m)
Water tank capacity	20 pt. - 3.2 qt. (3 liter) tank 35/50 pt. - 6.3 qt. (6 liter) tank
Moisture removal rate	20, 35, or 50 pints/day (9.5, 16.6, or 23.7 liters/day)

ONE-YEAR LIMITED WARRANTY

Definitions:

The Distributor* of Insignia branded products warrants to you, the original purchaser of this new Insignia-branded product ("Product"), that the Product shall be free of defects in the original manufacturer of the material or workmanship for a period of one (1) year from the date of your purchase of the Product ("Warranty Period").

For this warranty to apply, your Product must be purchased in the United States or Canada from a Best Buy branded retail store or online at www.bestbuy.com or www.bestbuy.ca and is packaged with this warranty statement.

How long does the coverage last?

The Warranty Period lasts for 1 year (365 days) from the date you purchased the Product. Your purchase date is printed on the receipt you received with the Product.

What does this warranty cover?

During the Warranty Period, if the original manufacture of the material or workmanship of the Product is determined to be defective by an authorized Insignia repair center or store personnel, Insignia will (at its sole option): (1) repair the Product with new or rebuilt parts; or (2) replace the Product at no charge with new or rebuilt comparable products or parts. Products and parts replaced under this warranty become the property of Insignia and are not returned to you. If service of Products or parts are required after the Warranty Period expires, you must pay all labor and parts charges. This warranty lasts as long as you own your Insignia Product during the Warranty Period. Warranty coverage terminates if you sell or otherwise transfer the Product.

How to obtain warranty service?

If you purchased the Product at a Best Buy retail store location or from a Best Buy online website (www.bestbuy.com or www.bestbuy.ca), please take your original receipt and the Product to any Best Buy store. Make sure that you place the Product in its original packaging or packaging that provides the same amount of protection as the original packaging.

To obtain warranty service, in the United States and Canada call 1-877-467-4289. Call agents may diagnose and correct the issue over the phone.

Where is the warranty valid?

This warranty is valid only in the United States and Canada at Best Buy branded retail stores or websites to the original purchaser of the product in the country where the original purchase was made.

What does the warranty not cover?

This warranty does not cover:

- Food, beverage, and/or medicine loss/spoilage.
- Customer instruction/education
- Installation
- Set up adjustments
- Cosmetic damage
- Damage due to weather, lightning, and other acts of God, such as power surges
- Accidental damage
- Misuse
- Abuse
- Negligence
- Commercial purposes/use, including but not limited to use in a place of business or in communal areas of a multiple dwelling condominium or apartment complex, or otherwise used in a place of other than a private home.
- Modification of any part of the Product, including the antenna
- Display panel damaged by static (non-moving) images applied for lengthy periods (burn-in).

- Damage due to incorrect operation or maintenance
- Connection to an incorrect voltage or power supply
- Attempted repair by any person not authorized by Insignia to service the Product
- Products sold “as is” or “with all faults”
- Consumables, including but not limited to batteries (i.e. AA, AAA, C etc.)
- Products where the factory applied serial number has been altered or removed
- Loss or Theft of this product or any part of the product
- Display panels containing up to three (3) pixel failures (dots that are dark or incorrectly illuminated) grouped in an area smaller than one tenth (1/10) of the display size or up to five (5) pixel failures throughout the display. (Pixel based displays may contain a limited number of pixels that may not function normally.)
- Failures or Damage caused by any contact including but not limited to liquids, gels or pastes.

REPAIR REPLACEMENT AS PROVIDED UNDER THIS WARRANTY IS YOUR EXCLUSIVE REMEDY FOR BREACH OF WARRANTY. INSIGNIA SHALL NOT BE LIABLE FOR ANY INCIDENTAL OR CONSEQUENTIAL DAMAGES FOR THE BREACH OF ANY EXPRESS OR IMPLIED WARRANTY ON THIS PRODUCT, INCLUDING, BUT NOT LIMITED TO, LOST DATA, LOSS OF USE OF YOUR PRODUCT, LOST BUSINESS OR LOST PROFITS. INSIGNIA PRODUCTS MAKES NO OTHER EXPRESS WARRANTIES WITH RESPECT TO THE PRODUCT, ALL EXPRESS AND IMPLIED WARRANTIES FOR THE PRODUCT, INCLUDING BUT NOT LIMITED TO ANY IMPLIED WARRANTIES OF AND CONDITIONS OF MERCHANTABILITY AND FITNESS FOR A PARTICULAR PURPOSE, ARE LIMITED IN DURATION TO THE WARRANTY PERIOD SET FORTH ABOVE AND NO WARRANTIES, WHETHER EXPRESS OR IMPLIED, WILL APPLY AFTER THE WARRANTY PERIOD. SOME STATES, PROVINCES AND JURISDICTIONS DO NOT ALLOW LIMITATIONS ON HOW LONG AN IMPLIED WARRANTY LASTS, SO THE ABOVE LIMITATION MAY NOT APPLY TO YOU. THIS WARRANTY GIVES YOU SPECIFIC LEGAL RIGHTS, AND YOU MAY ALSO HAVE OTHER RIGHTS, WHICH VARY FROM STATE TO STATE OR PROVINCE TO PROVINCE.

Contact Insignia:

1-877-467-4289

www.insigniaproducts.com

INSIGNIA is a trademark of Best Buy and its affiliated companies.

*Distributed by Best Buy Purchasing, LLC

7601 Penn Ave South, Richfield, MN 55423 U.S.A.

©2022 Best Buy. All rights reserved.

INSIGNIA™

www.insigniaproducts.com

1-877-467-4289 (U.S. and Canada)

INSIGNIA is a trademark of Best Buy and its affiliated companies.

Distributed by Best Buy Purchasing, LLC

7601 Penn Ave South, Richfield, MN 55423 U.S.A.

©2022 Best Buy. All rights reserved.

V4 ENGLISH
22-0898