

INSIGNIA™

USER GUIDE

5 Qt. Digital Control Air Fryer

NS-AF5DSS2 / NS-AF5DSS2-C



Before using your new product, please read these instructions to prevent any damage.

Contents

Introduction	2
IMPORTANT SAFEGUARDS	2
Notes on the plug	5
Notes on the cord	5
Plasticizer warning	5
Electric power	5
Automatic switch-off	5
Overheating protection	5
Automatic switch-off	5
Features	6
Package contents	6
Control and display panel	6
Before using your fryer for the first time	7
Using your air fryer	7
Using the preheat feature	8
Preset food temperatures and times	9
Food preparation temperatures and times	9
Removing the basket	10
Cleaning your air fryer	11
Storing your air fryer	11
Troubleshooting	11
Specifications	13
ONE-YEAR LIMITED WARRANTY	14

Introduction

Congratulations on your purchase of a high-quality Insignia product. Your NS-AF5DSS2 or NS-AF5DSS2-C represents the state of the art in air fryer design and is designed for reliable and trouble-free performance.

IMPORTANT SAFEGUARDS



WARNING: Read this manual carefully and completely and retain for future reference. Failure to adhere to safety instructions may result in serious injury or damage.

When using electrical appliances, basic safety precautions should always be followed:

- 1 This appliance can be used by persons with reduced physical, sensory or mental capabilities or lack of experience and knowledge if they have been given supervision or instruction concerning the use of the appliance in a safe way and understand the hazards involved.
- 2 Keep the appliance and its cord out of reach of children. **DO NOT** allow the appliance to be used by children. Close supervision is necessary when used near children.
- 3 Children should not play with the appliance.
- 4 **NEVER** use electrical socket below counter.
- 5 **NEVER** connect this appliance to an external timer switch or separate remote-control system.
- 6 When using this appliance, provide at least 6 inches (15.25 cm) of space above and on all sides for air circulation.
- 7 To protect against electrical shock, **DO NOT** immerse cord, plugs, or main unit housing in water or other liquid. Cook only in the basket provided.
- 8 Regularly inspect the appliance and power cord. **DO NOT** use the appliance if there is damage to the power cord or plug. If the appliance malfunctions or has been damaged in any way, immediately stop use and call Customer Service.
- 9 **DO NOT** use an extension short cord. A short power-supply cord is used to reduce the risk of children grabbing the cord or becoming entangled and to reduce the risk of people tripping over a longer cord.
- 10 **ALWAYS** ensure the appliance is properly assembled before use.
- 11 **DO NOT** cover the air intake vent or air outlet while unit is operating. Doing so will prevent even cooking and may damage the unit or cause it to overheat.
- 12 Before placing removable basket into the main unit, ensure basket and unit are clean and dry by wiping with a soft cloth.
- 13 This appliance is for household use only. **DO NOT** use this appliance for anything other than its intended use. **DO NOT** use in moving vehicles or boats. **DO NOT** use outdoors. Misuse may cause injury.
- 14 Intended for worktop use only. Ensure the surface is level, clean and dry. **DO NOT** move the appliance when in use.
- 15 **DO NOT** place the appliance near the edge of a worktop during operation.
- 16 **DO NOT** use accessory attachments not recommended or sold by the manufacturer. **DO NOT** place accessories in a microwave, toaster oven, convection oven, or conventional oven or on a ceramic cooktop, electric coil, gas burner range or outdoor grill. The use of accessory attachments not recommended by the manufacturer may cause fire, electric shock or injuries.
- 17 **ALWAYS** ensure basket is properly closed before operating.
- 18 **DO NOT** use the appliance without the removable basket installed.
- 19 **DO NOT** use this appliance for deep-frying.
- 20 **DO NOT** place appliance on hot surfaces or near a hot gas or electric burner or in a heated oven.

- 21 Prevent food contact with heating elements. **DO NOT** overfill when cooking. Overfilling may cause personal injury or property damage or affect the safe use of the appliance.
- 22 **DO NOT** place items on top of unit at any time.
- 23 Socket voltages can vary, affecting the performance of your product. To prevent possible illness, use a thermometer to check that your food is cooked to the temperatures recommended.
- 24 Should the unit emit black smoke, unplug immediately. Wait for smoking to stop before removing any cooking accessories.
- 25 **DO NOT** touch hot surfaces. Appliance surfaces are hot during and after operation. To prevent burns or personal injury, **ALWAYS** use protective hot pads or insulated oven mitts and use available handles.
- 26 Extreme caution must be used when the appliance contains hot food. Improper use may result in personal injury.
- 27 This appliance has a polarized plug (one blade is wider than the other). To reduce the risk of electric shock, this plug is intended to fit into a polarized outlet only one way. If the plug does not fit fully into the outlet, reverse the plug. If it still does not fit, contact a qualified electrician. **DO NOT** attempt to modify the plug in any way.
- 28 Spilled food can cause serious burns. Keep appliance and cord away from children. **DO NOT** let cord hang over edges of tables or counters or touch hot surfaces.
- 29 The basket and crisper plate become extremely hot during the cooking process. Avoid physical contact while removing the basket or plate from the appliance. **ALWAYS** place basket or plate on a heat-resistant surface after removing. **DO NOT** touch accessories during or immediately after cooking.
- 30 Cleaning and user maintenance should not be carried out by children.
- 31 To disconnect, press the power button to turn off the unit, then unplug from socket when not in use and before cleaning. Allow to cool before cleaning, disassembly, putting in or taking off parts and storage.
- 32 **DO NOT** clean with metal scouring pads. Pieces can break off the pad and touch electrical parts, creating the risk of electric shock. Please refer to Cleaning your air fryer on page 11 for regular maintenance of the appliance.

SAVE THESE INSTRUCTIONS



California Residents

WARNING: Cancer and reproductive harm -
www.p65warnings.ca.gov



WARNING: To avoid injury, read and understand the instructions in this user manual before attempting to use this appliance.

**WARNING:**

- Electrical shock hazard. Use grounded outlet only.
- DO NOT remove ground.
 - DO NOT use an adapter
 - DO NOT use an extension cord.

Failure to follow these instructions may result in electric shock and/or serious injury.



WARNING: THE FAILURE TO FOLLOW ANY OF THE IMPORTANT SAFEGUARDS AND/OR THE INSTRUCTIONS FOR SAFE USE IS A MISUSE OF YOUR APPLIANCE THAT CAN VOID YOUR WARRANTY AND CREATE THE RISK OF SERIOUS INJURY.

Notes on the plug

This appliance has a polarized plug (one blade is wider than the other). To reduce the risk of electric shock, this plug fits in a polarized outlet only one way. If the plug does not fit fully into the outlet, reverse the plug. If it still does not fit, contact a qualified electrician. Do not modify the plug in any way.

Notes on the cord

The provided short power-supply cord should be used to reduce the risk resulting from becoming entangled in or tripping over a longer cord. An extension cord is not recommended for use with this product. Always plug directly into a wall outlet or receptacle.

Plasticizer warning

CAUTION: To prevent plasticizers from migrating to the finish of the counter top or table top or other furniture, place NON-PLASTIC coasters or place mats between the appliance and the finish of the counter top or table top. Failure to do so may cause the finish to darken. Permanent blemishes may occur or stains can appear.

Electric power

If the electrical circuit is overloaded with other appliances, your appliance may not operate properly. It should be operated on a separate electrical circuit from other appliances.

Overheating protection

The fryer has an overheating protection system. If the inner temperature control system is invalid, the overheating protection is automatically turned on, and the fryer is no longer ready to be used. Unplug the power cord, let the fryer cool down, and send it to an authorized service center for repair.

Automatic switch-off

When the timer display has counted down to 0, the fryer produces a bell sound and switches off automatically.

Note: If the pan is pulled out during cooking, the fryer is switched off automatically.

Features

- Fryer circulates hot air to cook
- Temperature range from 180~400°F (82.2~204.4°C) to fry, roast, or bake your favorite foods
- 5-quart (4.8 l) basket holds 3-5 servings of food
- Digital controls provide an easy interface to adjust settings
- Timer with auto shutoff lets you cook your food from 0 to 60 minutes
- Dishwasher-safe basket and pan make cleanup easy

Package contents

- Air fryer
- *User Guide*

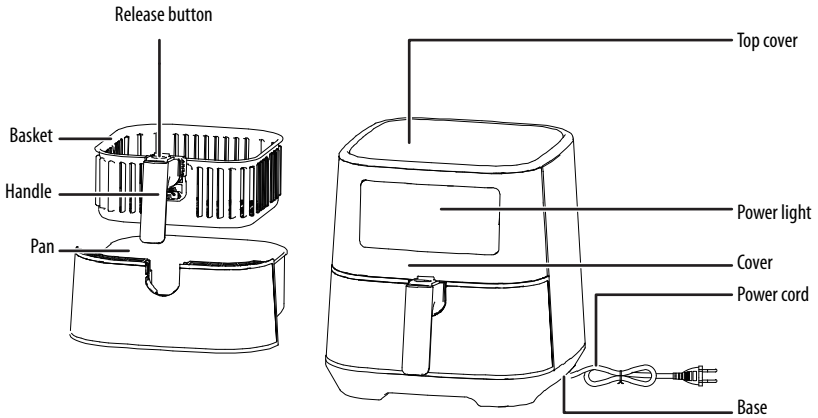

Control and display panel

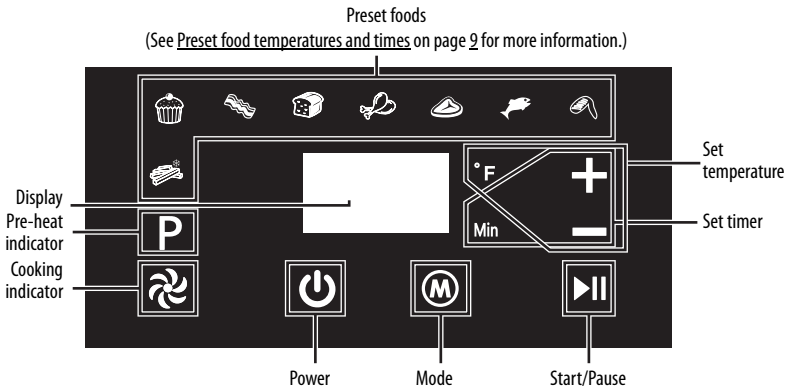











Before using your fryer for the first time

- 1 Remove all packaging material, stickers, and labels from your air fryer.
- 2 Clean the basket and pan with hot water, dish soap, and a non-abrasive sponge.
- 3 Wipe the inside and outside of your fryer with a moist cloth.

Using your air fryer



Caution:

- Your air fryer works with hot air. Do not fill the pan with oil or any liquid.
- Do not place anything next to the air outlet on the back of your air fryer or on the air inlet on top of your air fryer.

- 1 Place your air fryer on a level, heat-resistant surface and plug the power cord into a wall outlet. All the icons light up for a second, then turn off. The  (power) icon stays red.
- 2 Pull the pan out of your air fryer, place your food in the basket, then replace the pan.
- 3 Press  (power) to turn on your air fryer.
- 4 After preheating, press **M** (mode) repeatedly to select the preset food item that you want to cook. You can select  French fries,  pastries,  bacon,  bread,  chicken,  steak,  fish, or  chicken wing. The selected preset food blinks.
OR
If you do not select a preset, use the set temperature and set timer buttons (+ and -) to change the temperature and time, as needed.

Note:

- See [Preset food temperatures and times](#) on page 9 for a list of each preset food item's default time and temperature. You can use the set temperature and set timer buttons (+ and -) to change the preset temperature and time, as needed.
- You can press  (start/pause) to pause cooking. While paused, you can change the cooking mode, time, and temperature. Press this button again to resume cooking.

- 5 Press  (start/pause) or wait 10 seconds. Your air fryer starts, the timer counts down, and the  cooking indicator flashes.

Note: You can pull out the pan at any time to check your food. Your air fryer pauses automatically and resumes after you slide the pan back into your air fryer.



- 6 If you're cooking a large amount of food, remove the pan and shake its contents halfway through the cook time. Your air fryer and timer automatically continue after you replace the pan.

Notes:

- Your fryer doesn't beep at the halfway point.
- Remove the basket to reduce the weight while shaking. See [Removing the basket](#) on page 10 for more information.

- 7 When the cook time is finished, the air fryer lets heat dissipate for 20 seconds, then beeps to alert you that the cycle is done. Pull the pan out of your air fryer and place it on a heat-resistant surface.

Notes:

- If you do not want to wait for the heat to dissipate, press  (power) stop the cycle, then pull out the pan.
- You can stop the cycle any time by pressing  (power). When the  (power) icon is red, pull out the pan.

- 8 Make sure that your food is done. If it's not finished, slide the pan back into your air fryer, then start it again.
- 9 When finished, empty the basket into a bowl or onto a plate.

Tips:

- To remove small food, press the basket release button and lift the basket out of the pan.
- To remove large or fragile food, use a pair of tongs to lift the ingredients out of the basket.

- 10 Press  (power) to turn off your air fryer and unplug it from the wall outlet.









Using the preheat feature

Use the preheat (**P**) feature to save time and help make air frying perfect. Use the preheat feature:

- If a recipe calls for a preheated oven
 - When cooking meats or proteins that benefit from a hot initial searing
- 1 Place the empty pan and basket into your air fryer.
 - 2 Press  (power) to start preheating. You cannot change the preheat time (3 minutes) or temperature (400° F).
 - 3 When your air fryer beeps once, place food into the basket and program the cooking time and temperature.

Preset food temperatures and times

This table shows the default temperature and time settings for items on the preset menu. You can use the set temperature and set timer buttons (+ and -) to change the preset temperature and time, as needed. Press **P** (Preheat) before selecting a food preset.

FOOD PRESET	DEFAULT TEMPERATURE	DEFAULT TIME
 French fries	400° F (204° C)	13 minutes
 Pastries	360° F (182° C)	15 minutes
 Bacon	400° F (204° C)	8 minutes
 Bread	360° F (182° C)	23 minutes
 Chicken	360° F (182° C)	20 minutes
 Steak	360° F (182° C)	10 minutes
 Fish	400° F (204° C)	12 minutes
 Chicken wing	360° F (182° C)	20 minutes

IMPORTANT: When not using the preheat (**P**) function, increase the final cooking time by three minutes.

Food preparation temperatures and times

Because ingredients differ in origin, size, shape, and brand, you may need to adjust the cook times and temperatures in this table to suit your food.

FOOD	TEMP.	TIME	AMOUNT	NOTES
Potatoes & fries				
Thin frozen fries	390°F (199°C)	9-16 min.	11-25 oz. (300-700 g)	Shake halfway
Thick frozen fries	390°F (199°C)	11-20 min.	11-25 oz. (300-700 g)	Shake halfway
Homemade fries (8x8 mm)	390°F (199°C)	16-20 min.	11-28 oz. (300-800 g)	Shake halfway
Homemade potato wedges	355°F (179°C)	18-22 min.	11-28 oz. (300-800 g)	Shake halfway
Homemade potato cubes	355°F (179°C)	12-18 min.	9 oz. (250 g)	Shake halfway
Rosti	355°F (179°C)	15-18 min.	18 oz. (500 g)	Shake halfway
Potato gratin	390°F (199°C)	15-18 min.	18 oz. (500 g)	Shake halfway

FOOD	TEMP.	TIME	AMOUNT	NOTES
Meat & poultry				
Steak	360°F (182°C)	8-12 min.	6-18 oz. (100-500 g)	
Pork chops	360°F (182°C)	10-14 min.	6-18 oz. (100-500 g)	
Hamburger	360°F (182°C)	7-14 min.	6-18 oz. (100-500 g)	
Sausage roll	390°F (199°C)	13-15 min.	6-18 oz. (100-500 g)	
Drumsticks	360°F (182°C)	18-22 min.	6-18 oz. (100-500 g)	
Chicken breast	360°F (182°C)	10-15 min.	6-18 oz. (100-500 g)	
Bacon	400°F (204°C)	6-10 min.	11 oz. (300 g)	
Fish	360°F (182°C)	10-14 min.	18-28 oz. (500-800 g)	
Snacks				
Spring rolls	390°F (199°C)	8-10 min.	4-14 oz. (100-400 g)	Shake halfway
Frozen chicken nuggets	390°F (199°C)	6-10 min.	6-18 oz. (100-500 g)	Shake halfway
Frozen fish fingers	390°F (199°C)	6-10 min.	4-14 oz. (100-400 g)	
Frozen cheese curds	355°F (179°C)	8-10 min.	4-14 oz. (100-400 g)	
Stuffed vegetables	320°F (150°C)	10 min.	4-14 oz. (100-400 g)	
Baking				
Cake	320°F (150°C)	20-25 min.	11 oz. (300 g)	
Quiche	355°F (179°C)	20-22 min.	14 oz. (400 g)	
Muffins	390°F (199°C)	15-18 min.	11 oz. (300 g)	
Sweet snacks	320°F (150°C)	20 min.	14 oz. (400 g)	
Bread	360°F (182°C)	15-18 min.	11-18 oz. (300-500 g)	

Removing the basket

- 1 Pull your air fryer's handle out to slide the pan out.
- 2 Set the pan on a countertop.
- 3 Slide the release button cover forward to expose the red release button.
- 4 Press the release button, then lift the basket out of the pan.
- 5 To replace the basket, place it in the pan and press down until the basket locks into place, then slide the safety tab back over the release button.

Cleaning your air fryer

Clean your air fryer after every use.

Note: Do not use abrasive cleaning materials to clean the pan and basket because they may damage the nonstick coating.

- 1 Unplug your air fryer from the wall outlet and wait for it to cool.

Note: Remove the pan to let your air fryer cool down more quickly.

- 2 Wipe the outside of your air fryer with a moist cloth.
- 3 Clean the pan and the basket with hot water, dish soap, and a non-abrasive sponge. Use a degreasing liquid to remove any remaining residue.



Tip: For tough-to-remove residue, fill the pan with hot water and dish soap, then place the basket in the pan and soak for approximately ten minutes.

- 4 Clean the inside of your air fryer with hot water and a non-abrasive sponge.
- 5 Clean the heating element with a cleaning brush to remove any food residue.

Storing your air fryer

- 1 Unplug your air fryer and let it cool down.
- 2 Make sure that all parts are clean and dry.
- 3 Put your air fryer in a clean and dry place.

Troubleshooting

PROBLEM	POSSIBLE CAUSE	SOLUTION
Your air fryer doesn't work.	Your fryer is not plugged in.	Plug the power cord into a grounded wall outlet.
	You haven't set the temperature or timer.	Press  (power) to turn on your fryer, adjust settings, then press  (power) again to start.
	The pan isn't put into your fryer correctly.	Your air fryer won't turn on unless the pan is fully inserted. Slide the pan into your fryer correctly.
You smell a burnt food odor when you turn on your fryer for the first time.	Manufacturing residue is in your fryer.	Before using your fryer for the first time, we recommend that you heat it for five minutes to eliminate any manufacturing residue that may remain after shipping.

PROBLEM	POSSIBLE CAUSE	SOLUTION
The food fried in your air fryer isn't done.	There's too much food in your air fryer.	Put smaller batches of ingredients in the basket. Smaller batches fry more evenly.
	The set temperature is too low.	Increase your air fryer's temperature.
	The preparation time is too short.	Cook your food longer.
The ingredients are fried unevenly in your air fryer.	Certain types of ingredients need to be shaken halfway through the preparation time.	Shake foods that lie on top of or across each other (such as fries) halfway through the preparation time.
Fried snacks aren't crispy when they come out of your air fryer.	You used a type of snacks meant to be prepared in a traditional deep fryer.	Use oven snacks.
You can't slide the pan into your fryer correctly.	There's too much food in the basket.	Do not fill the basket beyond the MAX indication.
	The basket isn't placed in the pan correctly.	Push the basket down into the pan until you hear a click.
White smoke comes out of your air fryer.	You are preparing greasy ingredients.	When you fry greasy ingredients in your air fryer, a large amount of oil leaks into the pan. The oil produces white smoke and the pan may heat up more than usual. This does not affect your fryer or the end result.
	The pan still has grease residue from a previous use.	White smoke is caused by grease heating up in the pan. Make sure that you clean the pan correctly after each use.
Fresh fries are fried unevenly in your air fryer.	You didn't use the right potato type.	Use fresh potatoes to make sure that they stay firm during frying.
	You didn't rinse the fries correctly before you fried them.	Rinse the fries correctly to remove starch from the outside of the sticks.
Fresh fries aren't crispy when they come out of your air fryer.	The crispiness of the fries depends on the amount of oil and water in the fries.	Make sure that you dry the potato sticks correctly.
		Cut the potato sticks smaller for a crispier result.

Specifications

Dimensions (H × W × D)	12.8 × 14.8 × 12.4 in. (32.6 × 37.7 × 31.4 cm)
Weight	13.2 lbs. (6 kg)
Power requirements	1700W
Current	120V, 60Hz
Operating temperature	180 ~ 400°F (82.2 ~ 204.4°C)
Cord length	3.3 ft. (1.0 m)

ONE-YEAR LIMITED WARRANTY

Definitions:

The Distributor* of Insignia branded products warrants to you, the original purchaser of this new Insignia-branded product ("Product"), that the Product shall be free of defects in the original manufacturer of the material or workmanship for a period of one (1) year from the date of your purchase of the Product ("Warranty Period").

For this warranty to apply, your Product must be purchased in the United States or Canada from a Best Buy branded retail store or online at www.bestbuy.com or www.bestbuy.ca and is packaged with this warranty statement.

How long does the coverage last?

The Warranty Period lasts for 1 year (365 days) from the date you purchased the Product. Your purchase date is printed on the receipt you received with the Product.

What does this warranty cover?

During the Warranty Period, if the original manufacture of the material or workmanship of the Product is determined to be defective by an authorized Insignia repair center or store personnel, Insignia will (at its sole option): (1) repair the Product with new or rebuilt parts; or (2) replace the Product at no charge with new or rebuilt comparable products or parts. Products and parts replaced under this warranty become the property of Insignia and are not returned to you. If service of Products or parts are required after the Warranty Period expires, you must pay all labor and parts charges. This warranty lasts as long as you own your Insignia Product during the Warranty Period. Warranty coverage terminates if you sell or otherwise transfer the Product.

How to obtain warranty service?

If you purchased the Product at a Best Buy retail store location or from a Best Buy online website (www.bestbuy.com or www.bestbuy.ca), please take your original receipt and the Product to any Best Buy store. Make sure that you place the Product in its original packaging or packaging that provides the same amount of protection as the original packaging.

To obtain warranty service, in the United States and Canada call 1-877-467-4289. Call agents may diagnose and correct the issue over the phone.

Where is the warranty valid?

This warranty is valid only in the United States and Canada at Best Buy branded retail stores or websites to the original purchaser of the product in the country where the original purchase was made.

What does the warranty not cover?

This warranty does not cover:

- Food loss/spoilage due to failure of refrigerator or freezer
- Customer instruction/education
- Installation
- Set up adjustments
- Cosmetic damage
- Damage due to weather, lightning, and other acts of God, such as power surges
- Accidental damage
- Misuse
- Abuse
- Negligence
- Commercial purposes/use, including but not limited to use in a place of business or in communal areas of a multiple dwelling condominium or apartment complex, or otherwise used in a place of other than a private home.
- Modification of any part of the Product, including the antenna
- Display panel damaged by static (non-moving) images applied for lengthy periods (burn-in).

- Damage due to incorrect operation or maintenance
- Connection to an incorrect voltage or power supply
- Attempted repair by any person not authorized by Insignia to service the Product
- Products sold “as is” or “with all faults”
- Consumables, including but not limited to batteries (i.e. AA, AAA, C etc.)
- Products where the factory applied serial number has been altered or removed
- Loss or Theft of this product or any part of the product
- Display panels containing up to three (3) pixel failures (dots that are dark or incorrectly illuminated) grouped in an area smaller than one tenth (1/10) of the display size or up to five (5) pixel failures throughout the display. (Pixel based displays may contain a limited number of pixels that may not function normally.)
- Failures or Damage caused by any contact including but not limited to liquids, gels or pastes.

REPAIR REPLACEMENT AS PROVIDED UNDER THIS WARRANTY IS YOUR EXCLUSIVE REMEDY FOR BREACH OF WARRANTY. INSIGNIA SHALL NOT BE LIABLE FOR ANY INCIDENTAL OR CONSEQUENTIAL DAMAGES FOR THE BREACH OF ANY EXPRESS OR IMPLIED WARRANTY ON THIS PRODUCT, INCLUDING, BUT NOT LIMITED TO, LOST DATA, LOSS OF USE OF YOUR PRODUCT, LOST BUSINESS OR LOST PROFITS. INSIGNIA PRODUCTS MAKES NO OTHER EXPRESS WARRANTIES WITH RESPECT TO THE PRODUCT, ALL EXPRESS AND IMPLIED WARRANTIES FOR THE PRODUCT, INCLUDING BUT NOT LIMITED TO ANY IMPLIED WARRANTIES OF AND CONDITIONS OF MERCHANTABILITY AND FITNESS FOR A PARTICULAR PURPOSE, ARE LIMITED IN DURATION TO THE WARRANTY PERIOD SET FORTH ABOVE AND NO WARRANTIES, WHETHER EXPRESS OR IMPLIED, WILL APPLY AFTER THE WARRANTY PERIOD. SOME STATES, PROVINCES AND JURISDICTIONS DO NOT ALLOW LIMITATIONS ON HOW LONG AN IMPLIED WARRANTY LASTS, SO THE ABOVE LIMITATION MAY NOT APPLY TO YOU. THIS WARRANTY GIVES YOU SPECIFIC LEGAL RIGHTS, AND YOU MAY ALSO HAVE OTHER RIGHTS, WHICH VARY FROM STATE TO STATE OR PROVINCE TO PROVINCE.

Contact Insignia:

1-877-467-4289

www.insigniaproducts.com

INSIGNIA is a trademark of Best Buy and its affiliated companies.

*Distributed by Best Buy Purchasing, LLC

7601 Penn Ave South, Richfield, MN 55423 U.S.A.

©2021 Best Buy. All rights reserved.

INSIGNIA™

www.insigniaproducts.com

1-877-467-4289 (U.S. and Canada)

INSIGNIA is a trademark of Best Buy and its affiliated companies.

Distributed by Best Buy Purchasing, LLC

7601 Penn Ave South, Richfield, MN 55423 U.S.A.

©2021 Best Buy. All rights reserved.

V3 ENGLISH
21-1123