

INSIGNIA™

8,000 BTU Window Air Conditioner

NS-AC8WU3

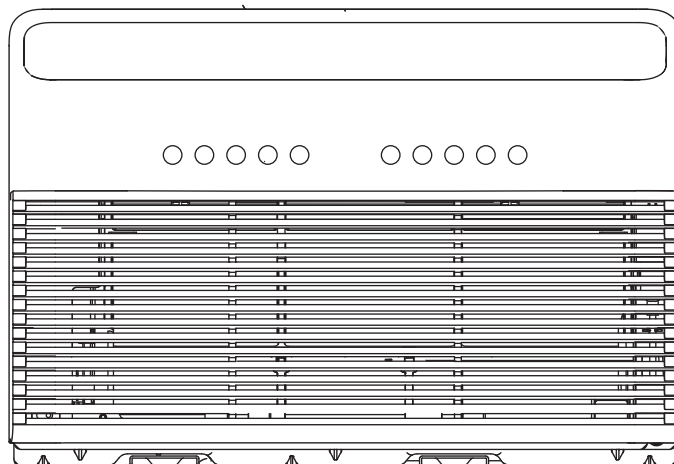

Before using your new product, please read these instructions to prevent any damage.

Contents

Introduction	3
IMPORTANT SAFEGUARDS	3
Features	10
Package contents	10
Air conditioner	11
Control panel	12
Remote control	13
Remote control display screen	14
Using the remote control	15
Before you mount your air conditioner	16
Understanding the window requirements	16
Installing your air conditioner	17
Step 1: Preparing the support bracket	17
Step 2: Installing the support bracket	18
Step 3: Installing your air conditioner on the support bracket	21
Step 4: Installing the sealing foam and anti-tip brackets	23
Using your air conditioner	27
Using your air conditioner for the first time	27
Turning your air conditioner on/off	27
Selecting an air conditioner mode	27
Selecting the fan speed	27
Using ECO (energy saver) mode	27
Setting the timer	27
Using the remote as a thermostat (I SENSE)	28
Using the check filter reminder	28
Using sleep mode	29
Turning the display on or off	29
Locking air conditioner settings	29
Controlling air flow	29
Understanding sounds	29
Cleaning and maintaining your air conditioner	30
Cleaning the cabinet	30
Cleaning the air filter	30
Storing your air conditioner	30
Removing your air conditioner from the window	30
Troubleshooting	31
Specifications	32
Legal notices	32
ONE-YEAR LIMITED WARRANTY	33

8,000 BTU Window Air Conditioner

Introduction

Congratulations on your purchase of a high-quality Insignia product. Your NS-AC8WU3 represents the state of the art in air conditioner design and is designed for reliable and trouble-free performance.

IMPORTANT SAFEGUARDS

Read this manual carefully before installing or operating your new air conditioning unit. Make sure that you save this manual for future reference.

To prevent injury to the user or other people and property damage, the following instructions must be followed. Incorrect operation due to ignoring of instructions may cause harm or damage. The seriousness is classified by the following indications.

	This symbol indicates the possibility of death or serious injury.
---	---

	This symbol indicates the possibility of injury or damage to property.
---	--

WARNING

- Plug in power plug properly. Otherwise, it may cause electric shock or fire due to excess heat generation.
- Always use a circuit breaker and a dedicated power circuit. Incorrect installation may cause fire and electric shock.
- Always ensure effective grounding. Incorrect grounding may cause electric shock.
- Unplug the unit if strange sounds, smell, or smoke comes from it. It may cause fire and electric shock.
- Keep firearms away. It may cause fire.
- Ventilate the room before operating your air conditioner if there is a gas leakage from another appliance. It may cause explosion, fire, and burns.
- Do not operate or stop the unit by inserting or pulling out the power plug. It may cause electric shock or fire due to heat generation.
- Do not operate with wet hands or in damp environment. It may cause electric shock.
- Do not allow water to run into electric parts. It may cause failure of machine or electric shock.
- Do not use the socket if it is loose or damaged. It may cause fire and electric shock.
- Do not use the power cord close to heating appliances. It may cause fire and electric shock.
- Do not damage or use an unspecified power cord. It may cause electric shock or fire. If the power cord is damaged, it must be replaced by the manufacturer or an authorized service center or a similarly qualified person in order to avoid a hazard.
- Do not direct airflow at room occupants only. This could damage your health.
- Do not modify power cord length or share the outlet with other appliances. It may cause electric shock or fire due to heat generation.
- Do not open the unit during operation. It may cause electric shock.
- Do not use the power cord near flammable gas or combustibles, such as gasoline, benzene, thinner, etc. It may cause an explosion or fire.
- Do not disassemble or modify unit. It may cause failure and electric shock.

CAUTION

- When your air filter is to be removed, do not touch the metal parts of the unit. It may cause an injury.
- Do not use strong detergent such as wax or thinner but use a soft cloth. Appearance may be deteriorated due to change of product color or scratching of its surface.
- Stop operation and close the window in storm or hurricane. Operation with windows opened may cause wetting of indoor and soaking of household furniture.
- Always insert the filters securely. Clean filter once every two weeks. Operation without filters may cause failure.

- Do not place obstacles around air-inlets or inside of air-outlet. It may cause failure of appliance or accident.
- Use caution when unpacking and installing. Sharp edges could cause injury.
- Do not put a pet or house plant where it will be exposed to direct air flow. This could injure the pet or plant.
- Do not clean your air conditioner with water. Water may enter the unit and degrade the insulation. It may cause an electric shock.
- When the unit is to be cleaned, switch off, and turn off the circuit breaker. Do not clean unit when power is on as it may cause fire and electric shock. It may cause an injury.
- Hold the plug by the head of the power plug when taking it out. It may cause electric shock and damage.
- Do not place heavy object on the power cord and ensure that the cord is not compressed. There is danger of fire or electric shock.
- Ventilate the room well when used together with a stove, etc. An oxygen shortage may occur.
- Do not use for special purposes. Do not use this air conditioner to preserve precision devices, food, pets, plants, and art objects. It may cause deterioration of quality, etc.
- Ensure that the installation bracket of the outdoor appliance is not damaged due to prolonged exposure. If bracket is damaged, there is concern of damage due to falling of unit.
- Turn off the main power switch when not using the unit for a long time. It may cause failure of product or fire.
- Do not drink water drained from air conditioner. It contains contaminants and could make you sick.
- If water enters the unit, turn the unit off at the power outlet and switch off the circuit breaker. Isolate from the electrical supply by taking the power-plug out and contact a qualified service technician.
- This appliance is not intended for use by persons (including children) with reduced physical, sensory, or mental capabilities or lack of experience and knowledge, unless they have been given supervision or instruction concerning use of the appliance by a person responsible for their safety.
- Children should be supervised to ensure that they do not play with the appliance.
- If the supply cord is damaged, it must be replaced by the manufacturer, its service agent, or similarly qualified persons in order to avoid a hazard.
- The appliance shall be installed in accordance with national wiring regulations.
- Do not operate your air conditioner in a wet room such as a bathroom or laundry room.
- Contact an authorized service technician for repair or maintenance of this unit.
- Contact an authorized installer for installation of this unit.

IMPORTANT SAFETY INSTRUCTIONS

- **NOTE:** The power supply cord with this air conditioner contains a current detection device designed to reduce the risk of fire. Please refer to Operation of Current Device on page 6 for details. In the event that the power supply cord is damaged, it cannot be repaired. It must be replaced with a cord from the product manufacturer.
- **WARNING:** Avoid fire hazard or electric shock. Do not use an extension cord or an adapter plug. Do not remove any prong from the power cord.

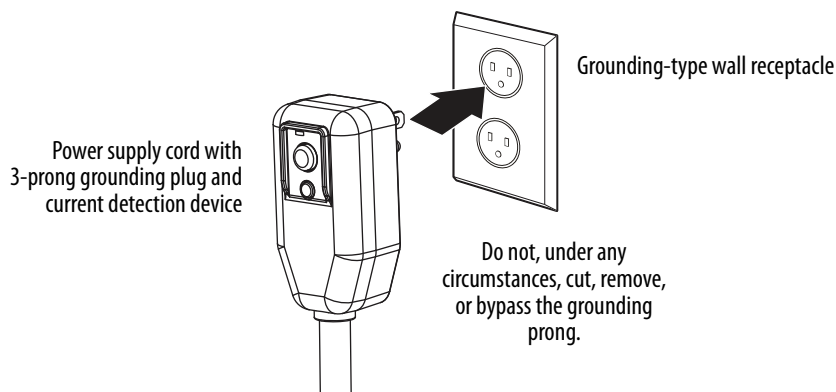

- **WARNING:** For your safety, do not store or use gasoline or other flammable vapors and liquids in the vicinity of this or any other appliance.
- Do not use this device to turn the unit on or off.
- Always make sure the RESET button is pushed in for correct operation.

- The power supply must be replaced if it fails reset when either the TEST button is pushed, or it cannot be reset. A new one can be obtained from the product manufacturer. If power supply cord is damaged, it cannot be repaired. It **MUST** be replaced by one obtained from the product manufacturer.



Caution: Risk of fire/flammable materials
(Required for R32/R290 units only)

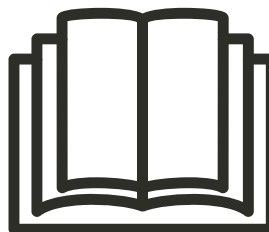

IMPORTANT NOTE: Read this manual carefully before installing or operating your new air conditioning unit. Make sure to save this manual for future reference.

- This air conditioner is designed to be operated under conditions as follows:

Cooling operation	Outdoor temperature	64~109° F (18~43° C) Note: 64~125° F/18~52° C for special tropical models
	Indoor temperature	60~90° F (16~32° C)
Note: Performance may be reduced outside of these operating temperatures.		

- Explanation of the symbols displayed on the unit (uses R290/R32 refrigerant only).

	WARNING	This symbol indicates that this appliance uses a flammable refrigerant. If the refrigerant leaks and is exposed to an external ignition source, there is a risk of fire.
	CAUTION	This symbol indicates that the operation manual should be read carefully.
	CAUTION	This symbol indicates that service personnel should be handling this equipment with reference to the installation manual.
	CAUTION	This symbol indicates that information is available, such as the operating manual or installation manual.

- WARNING:** (for using R290/R32 refrigerant only)
- Do not use heat as a means to accelerate the defrosting process or to clean, other than those recommended by the manufacturer.
- The appliance shall be stored in a room without continuously operating ignition sources (for example: open flames, an operating gas appliance) and ignition sources or (for example, an operating electric heater) close to the appliance. The appliance shall be stored in a room without continuously operating ignition sources (for example: open flames, an operating gas appliance or an operating electric heater).
- Do not pierce or burn.
- Be aware that the refrigerants may not contain an odor.
- Compliance with national gas regulations shall be observed.
- Keep ventilation openings clear of obstruction.
- The appliance shall be stored so as to prevent mechanical damage from occurring.
- A warning that the appliance shall be stored in a well-ventilated area where the room size corresponds to the room area as specified for operation.
- Any person who is involved with working on or breaking into a refrigerant circuit should hold a current valid certificate from an industry-accredited assessment authority, which authorizes their competence to handle refrigerants safely in accordance with an industry recognized assessment specification.
- Servicing shall only be performed as recommended by the equipment manufacturer. Maintenance and repair requiring the assistance of other skilled personnel shall be carried out under the supervision of the person competent in the use of flammable refrigerants.
- DO NOT modify the length of the power cord or use an extension cord to power the unit. DO NOT share a single outlet with other electrical appliances. Improper power supply can cause fire or electrical shock.

- Please follow the instruction carefully to handle, install, clear, and service your air conditioner to avoid any damage or hazard. Flammable Refrigerant R32 is used within air conditioner. When maintaining or disposing of the air conditioner, the refrigerant (R32 or R290) shall be recovered properly and shall not discharge to air directly.
- No open fire or device-like switch which may generate spark/arcing shall be around your air conditioner to avoid causing ignition of the flammable refrigerant used. Please follow the instruction carefully to store or maintain your air conditioner to prevent mechanical damage from occurring.
- Flammable refrigerant R32 is used in air conditioner. Please follow the instruction carefully to avoid any hazard.

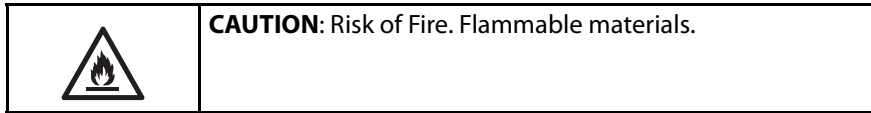

Prevent accidents

WARNING: To reduce the risk of fire, electrical shock, or injury to persons when using your air conditioner, follow basic precautions, including the following:

- Be sure the electrical service is adequate for the model you have chosen. This information can be found on the serial plate, which is located on the side of the cabinet and behind the grille.
- If the air conditioner is to be installed in a window, you will probably want to clean both sides of the glass first. If the window is a triple-track type with a screen panel included, remove the screen completely before installation.
- Be sure the air conditioner has been securely and correctly installed according to the installation instructions in this manual. Save this manual for possible future use in removing or installing this unit.
- When handling the air conditioner, be careful to avoid cuts from sharp metal fins on front and rear coils.

Electrical information

WARNING: The complete electrical rating of your new room air conditioner is stated on the serial plate. Refer to the rating when checking the electrical requirements.

- Be sure the air conditioner is properly grounded. To minimize shock and fire hazards, proper grounding is important. The power cord is equipped with a three-prong grounding plug for protection against shock hazards.
- Your air conditioner must be used in a properly grounded wall receptacle. If the wall receptacle you intend to use is not adequately grounded or protected by a time delay fuse or circuit breaker, have a qualified electrician install the proper receptacle. Ensure the receptacle is accessible after the unit installation.
- Do not run air conditioner without side protective cover in place. This could result in mechanical damage within the air conditioner.
- Do not use an extension cord or an adapter plug.

Operation of Current Device

(Applicable to the units with current detection device only)

The power supply cord contains a current device that senses damage to the power cord. To test your power supply cord do the following:

- 1 Plug in the air conditioner.
- 2 The power supply cord will have TWO buttons on the plug head. Press the **TEST** button. You will notice a click as the **RESET** button pops out.
- 3 Press the **RESET** button. Again you will notice a click as the button engages.
- 4 The power supply cord is now supplying electricity to the unit. (On some products this it also indicated by a light on the plug head.)

WARNINGS (for using R290/R32 refrigerant only)

- 1 Transport of equipment containing flammable refrigerants
See transport regulations
- 2 Marking of equipment using signs
See local regulations
- 3 Disposal of equipment using flammable refrigerants
See national regulations.
- 4 Storage of equipment/appliances
The storage of equipment should be in accordance with the manufacturer's instructions.
- 5 Storage of packed (unsold) equipment
Storage package protection should be constructed such that mechanical damage to the equipment inside the package will not cause a leak of the refrigerant charge. The maximum number of pieces of equipment permitted to be stored together will be determined by local regulations.

6 Information on servicing**A Checks to the area**

Prior to beginning work on systems containing flammable refrigerants, safety checks are necessary to ensure that the risk of ignition is minimized. For repair to the refrigerating system, the following precautions shall be complied with prior to conducting work on the system.

B Work procedure

Work shall be undertaken under a controlled procedure so as to minimize the risk of a flammable gas or vapor being present while the work is being performed.

C General work area

All maintenance staff and others working in the local area shall be instructed on the nature of work being carried out. Work in confined spaces shall be avoided. The area around the workspace shall be sectioned off. Ensure that the conditions within the area have been made safe by control of flammable material.

D Checking for presence of refrigerant

The area shall be checked with an appropriate refrigerant detector prior to and during work, to ensure the technician is aware of potentially flammable atmospheres. Ensure that the leak detection equipment being used is suitable for use with flammable refrigerants, i.e. non-sparking, adequately sealed, or intrinsically safe.

E Presence of fire extinguisher

If any hot work is to be conducted on the refrigeration equipment or any associated parts, appropriate fire extinguishing equipment shall be available to hand. Have a dry powder or CO² fire extinguisher adjacent to the charging area.

F No ignition sources

No person carrying out work in relation to a refrigeration system which involves exposing any pipe work that contains or has contained flammable refrigerant shall use any sources of ignition in such a manner that it may lead to the risk of fire or explosion. All possible ignition sources, including cigarette smoking, should be kept sufficiently far away from the site of installation, repairing, removing, and disposal, during which flammable refrigerant can possibly be released to the surrounding space. Prior to work taking place, the area around the equipment is to be surveyed to make sure that there are no flammable hazards or ignition risks. No Smoking signs shall be displayed.

G Ventilated area

Ensure that the area is in the open or that it is adequately ventilated before breaking into the system or conducting any hot work. A degree of ventilation shall continue during the period that the work is carried out. The ventilation should safely disperse any released refrigerant and preferably expel it externally into the atmosphere.

H Checks to the refrigeration equipment

Where electrical components are being changed, they shall be fit for the purpose and to the correct specification. At all times the manufacturer's maintenance and service guidelines shall be followed. If in doubt consult the manufacturer's technical department for assistance. The following checks shall be applied to installations using flammable refrigerants:

- The charge size is in accordance with the room size within which the refrigerant containing parts are installed;
- The ventilation machinery and outlets are operating adequately and are not obstructed; If an indirect refrigerating circuit is being used, the secondary circuit shall be checked for the presence of refrigerant;
- Marking to the equipment continues to be visible and legible. Markings and signs that are illegible shall be corrected;
- Refrigeration pipe or components are installed in a position where they are unlikely to be exposed to any substance which may corrode refrigerant containing components, unless the components are constructed of materials which are inherently resistant to being corroded or are suitably protected against being so corroded.

I Checks to electrical devices

Repair and maintenance to electrical components shall include initial safety checks and component inspection procedures. If a fault exists that could compromise safety, then no electrical supply shall be connected to the circuit until it is satisfactorily dealt with. If the fault cannot be corrected immediately but it is necessary to continue operation, an adequate temporary solution shall be used. This shall be reported to the owner of the equipment so all parties are advised. Initial safety checks shall include:

- That capacitors are discharged: this shall be done in a safe manner to avoid possibility of sparking;
- That no live electrical components and wiring are exposed while charging, recovering or purging the system;
- That there is continuity of earth bonding.

7 Repairs to sealed components

- During repairs to sealed components, all electrical supplies shall be disconnected from the equipment being worked upon prior to any removal of sealed covers, etc. If it is absolutely necessary to have an electrical supply to equipment during servicing, then a permanently operating form of leak detection shall be located at the most critical point to warn of a potentially hazardous situation.
- Particular attention shall be paid to the following to ensure that by working on electrical components, the casing is not altered in such a way that the level of protection is affected.

- This shall include damage to cables, excessive number of connections, terminals not made to original specification, damage to seals, incorrect fitting of glands, etc.
- Ensure that apparatus is mounted securely.
- Ensure that seals or sealing materials have not degraded such that they no longer serve the purpose of preventing the ingress of flammable atmospheres. Replacement parts shall be in accordance with the manufacturer's specifications.
- NOTE: The use of silicon sealant may inhibit the effectiveness of some types of leak detection equipment. Intrinsically safe components do not have to be isolated prior to working on them.

8 Repair to intrinsically safe components

Do not apply any permanent inductive or capacitance loads to the circuit without ensuring that this will not exceed the permissible voltage and current permitted for the equipment in use. Intrinsically safe components are the only types that can be worked on while live in the presence of a flammable atmosphere. The test apparatus shall be at the correct rating. Replace components only with parts specified by the manufacturer. Other parts may result in the ignition of refrigerant in the atmosphere from a leak.

9 Cabling

Check that cabling will not be subject to wear, corrosion, excessive pressure, vibration, sharp edges, or any other adverse environmental effects. The check shall also take into account the effects of aging or continual vibration from sources such as compressors or fans.

10 Detection of flammable refrigerants

Under no circumstances shall potential sources of ignition be used in the searching for or detection of refrigerant leaks. A halide torch (or any other detector using a naked flame) shall not be used.

11 Leak detection methods

The following leak detection methods are deemed acceptable for systems containing flammable refrigerants. Electronic leak detectors shall be used to detect flammable refrigerants, but the sensitivity may not be adequate, or may need re-calibration. (Detection equipment shall be calibrated in a refrigerant-free area.) Ensure that the detector is not a potential source of ignition and is suitable for the refrigerant used. Leak detection equipment shall be set at a percentage of the LFL of the refrigerant and shall be calibrated to the refrigerant employed and the appropriate percentage of gas (25% maximum) is confirmed. Leak detection fluids are suitable for use with most refrigerants but the use of detergents containing chlorine shall be avoided as the chlorine may react with the refrigerant and corrode the copper pipe-work. If a leak is suspected, all naked flames shall be removed/ extinguished. If a leakage of refrigerant is found which requires brazing, all of the refrigerant shall be recovered from the system, or isolated (by means of shut off valves) in a part of the system remote from the leak. Oxygen free nitrogen (OFN) shall then be purged through the system both before and during the brazing process.

12 Removal and evacuation

When breaking into the refrigerant circuit to make repairs or for any other purpose, conventional procedures shall be used. However, it is important that best practice is followed since flammability is a consideration. Opening of the refrigeration systems shall not be done by brazing. The following procedure shall be adhered to:

- Remove refrigerant;
- Purge the circuit with inert gas;
- Evacuate;
- Purge again with inert gas;
- Open the circuit by cutting or brazing.

The refrigerant charge shall be recovered into the correct recovery cylinders. The system shall be flushed with OFN to render the unit safe. This process may need to be repeated several times. Compressed air or oxygen shall not be used for this task.

Flushing shall be achieved by breaking the vacuum in the system with OFN and continuing to fill until the working pressure is achieved, then venting to atmosphere, and finally pulling down to a vacuum. This process shall be repeated until no refrigerant is within the system. When the final OFN charge is used, the system shall be vented down to atmospheric pressure to enable work to take place. This operation is absolutely vital if brazing operations on the pipe-work are to take place.

Ensure that the outlet for the vacuum pump is not close to any ignition sources and there is ventilation available.

13 Charging procedures

In addition to conventional charging procedures, the following requirements shall be followed.

- Ensure that contamination of different refrigerants does not occur when using charging equipment.
- Hoses or lines shall be as short as possible to minimize the amount of refrigerant contained in them.
- Cylinders shall be kept upright.
- Ensure that the refrigeration system is earthed prior to charging the system with refrigerant.
- Label the system when charging is complete (if not already).
- Extreme care shall be taken not to overfill the refrigeration system.
- Prior to recharging the system it shall be pressure tested with OFN. The system shall be leak tested on completion of charging but prior to commissioning. A follow up leak test shall be carried out prior to leaving the site.

14 Decommissioning

Before carrying out this procedure, it is essential that the technician is completely familiar with the equipment and all its detail. It is recommended good practice that all refrigerants are recovered safely. Prior to the task being carried out, an oil and refrigerant sample shall be taken in case analysis is required prior to re-use of reclaimed refrigerant. It is essential that electrical power is available before the task is commenced.

- A** Become familiar with the equipment and its operation.
- B** Isolate system electrically.
- C** Before attempting the procedure ensure that:
 - Mechanical handling equipment is available, if required, for handling refrigerant cylinders;
 - All personal protective equipment is available and being used correctly;
 - The recovery process is supervised at all times by a competent person;
 - Recovery equipment and cylinders conform to the appropriate standards.
- D** Pump down refrigerant system, if possible.
- E** If a vacuum is not possible, make a manifold so that refrigerant can be removed from various parts of the system.
- F** Make sure that cylinder is situated on the scales before recovery takes place.
- G** Start the recovery machine and operate in accordance with manufacturer's instructions.
- H** Do not overfill cylinders. (No more than 80% volume liquid charge).
- I** Do not exceed the maximum working pressure of the cylinder, even temporarily.
- J** When the cylinders have been filled correctly and the process completed, make sure that the cylinders and the equipment are removed from site promptly and all isolation valves on the equipment are closed off.
- K** Recovered refrigerant shall not be charged into another refrigeration system unless it has been cleaned and checked.

15 Labeling

Equipment shall be labeled stating that it has been de-commissioned and emptied of refrigerant. The label shall be dated and signed. Ensure that there are labels on the equipment stating the equipment contains flammable refrigerant.

16 Recovery

When removing refrigerant from a system, either for servicing or decommissioning, it is recommended good practice that all refrigerants are removed safely.

When transferring refrigerant into cylinders, ensure that only appropriate refrigerant recovery cylinders are employed. Ensure that the correct number of cylinders for holding the total system charge is available. All cylinders to be used are designated for the recovered refrigerant and labeled for that refrigerant (i.e. special cylinders for the recovery of refrigerant). Cylinders shall be complete with pressure relief valve and associated shut-off valves in good working order. Empty recovery cylinders are evacuated and, if possible, cooled before recovery occurs. The recovery equipment shall be in good working order with a set of instructions concerning the equipment that is at hand and shall be suitable for the recovery of flammable refrigerants. In addition, a set of calibrated weighing scales shall be available and in good working order. Hoses shall be complete with leak-free disconnect couplings and in good condition. Before using the recovery machine, check that it is in satisfactory working order, has been properly maintained and that any associated electrical components are sealed to prevent ignition in the event of a refrigerant release. Consult manufacturer if in doubt.

The recovered refrigerant shall be returned to the refrigerant supplier in the correct recovery cylinder, and the relevant Waste Transfer Note arranged. Do not mix refrigerants in recovery units and especially not in cylinders. If compressors or compressor oils are to be removed, ensure that they have been evacuated to an acceptable level to make certain that flammable refrigerant does not remain within the lubricant. The evacuation process shall be carried out prior to returning the compressor to the suppliers. Only electric heating to the compressor body shall be employed to accelerate this process. When oil is drained from a system, it shall be carried out safely.

Features

- 8,000 BTU is ideal for rooms up to 350 sq. ft. (32.5 sq. m) of living space
- Three unique fan speeds and a temperature range of 60° F-86° F(16° C-30° C) keep you cool and comfortable
- Specially designed to fit vertical sliding windows
- Digital controls make it quick and easy to adjust your settings
- Oscillating fan lets you manually adjust side-to-side motion
- Included remote control works from up to 26.2 ft. (8 m) away
- Auto restart function restores your previous settings, in the event of a power outage
- 4.9 ft. (1.5 m) power cord easily reaches nearby outlets
- Simple white color looks modern and matches any décor

Package contents

- Window air conditioner
- Mounting hardware
- Remote control
- AAA batteries (2)
- *User Guide*

Tools required



Phillips screwdriver



Level



Pencil

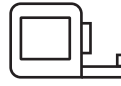

Tape measure

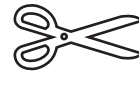

Scissors

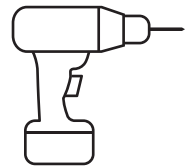

Drill and 1/8 in. bit



Flat blade screwdriver







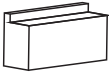

"L" shaped screwdriver

Installation hardware

	1/2 in. Type B Screw	2*
	1/4 in. Type B Screw	2*
	1/2 in. Type A Screw	3*
	1 in. Type A Screw	2*
	Support Bracket	1
	Right Extension Arm (for 26" to 36" window)	1
	Right Extension Arm (for 22" to 26" window)	1
	Main Support Pin	2*
	Cotter Pin	2*
	Open Window Bracket - RH	1
	Open Window Bracket - LH	1

* Indicates extra hardware provided in a separate bag.

	Side Arm Foam Block	2
	Window Sash Lock	1
	Window Sash Foam	1
	Window Sealing Foam	1
	Bracket Sealing Foam	1
	Additional Side Arm Foam	2

* Indicates extra hardware provided in a separate bag.

Note: Save the carton and these instructions for future reference. The carton is the best way to store your air conditioner during the winter or when not in use.

Air conditioner

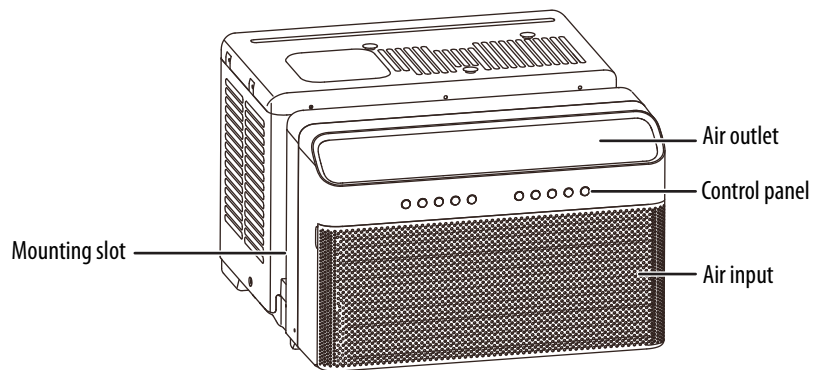

Air conditioner support bracket

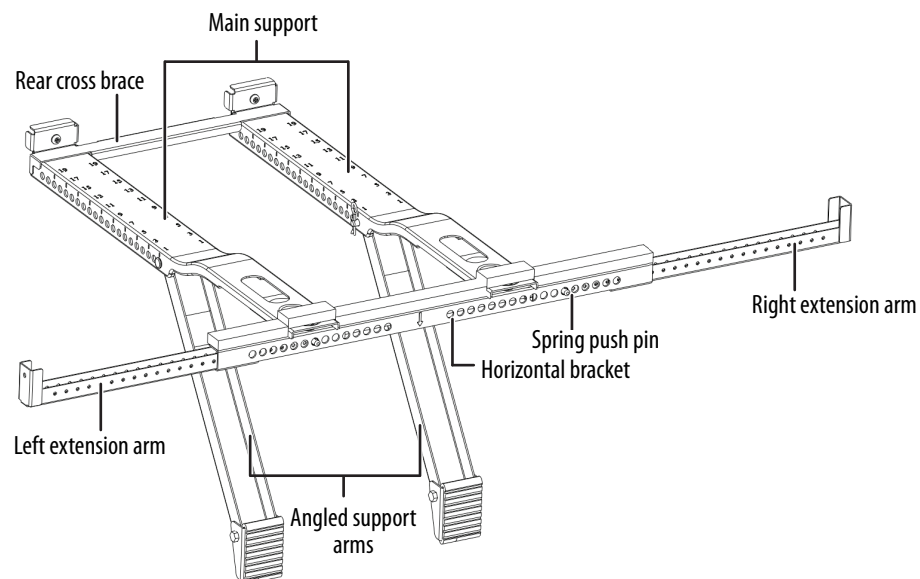

Control panel

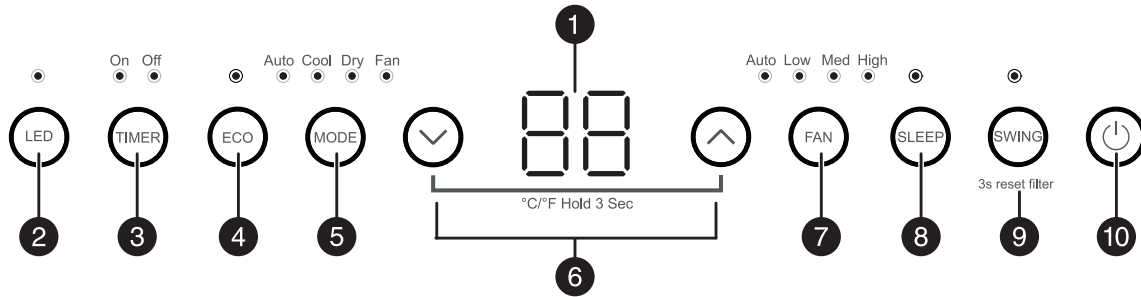

#	Item	Description
1	Display	Shows the set temperature in °F or °C (to switch, press and hold the (up) and (down) buttons at the same time for three seconds) and the Auto-timer settings. In Fan mode, it shows the room temperature. If the room temperature is too high or low, it displays "HI" or "LO". Error codes: If an error code appears on the display, wait for about 10 minutes and the problem may resolve itself. If not, disconnect the power, then connect it again and turn your air conditioner on. If the error code repeats and the problem persists, disconnect the power and contact your nearest customer service center. Error codes: EH(xx), EL(xx), EC(xx), PH(xx), PL(xx), PC(xx).
2	LED button	Press to turn on/off the display lighting and the control panel beep sound.
3	TIMER button and indicator LEDs	<ul style="list-style-type: none"> Press to turn the timer on or off. The ON or OFF indicator lights turn on to show the status of the timer. The timer initiates the Auto Start program. Press or press and hold the UP or DOWN buttons to change the Auto Start time by half hour increments up to 10 hours, then at one hour increments up to 24 hours. The control will count down the time remaining until start. The selected time will register in five seconds, and the system automatically reverts back to display the previous temperature setting or room temperature when your air conditioner is on. Turning your air conditioner ON or OFF at any time or adjusting the timer setting to 0.0 will cancel the timer.
4	ECO (Energy saver) button and indicator LED	Press to turn energy saver mode on or off. This function is available on COOL, DRY, and AUTO (AUTO-COOLING and AUTO-FAN) modes. The fan will continue to run for three minutes after the compressor shuts off. The fan then cycles on for two minutes at 10 minute intervals, until the room temperature is above the set temperature, at which time the compressor turns back on and cooling resumes. The indicator LED turns on to show that ECO mode is on.
5	MODE button and Mode indicator LEDs	Press to change the air conditioner mode. Mode LEDs indicate the mode selected. Your air conditioner automatically initiates the Energy Saver function in the Cool, Dry, and Auto (only Auto-Cooling and Auto-Fan) modes. The LEDs indicate the mode selected. Auto mode: <ul style="list-style-type: none"> In Auto mode, your air conditioner automatically selects cooling or fan only operation, depending on what temperature you have selected and the current room temperature. Your air conditioner controls the room temperature automatically based on the temperature you set. In this mode, the fan speed is set automatically and is based on room temperature. Cool mode: <ul style="list-style-type: none"> In Cool mode you set the temperature you want by pressing the Up and Down buttons. When Cool mode is selected, you can adjust the fan speed by pressing the FAN button. Dry mode: <ul style="list-style-type: none"> In Dry mode, your air conditioner operates as a dehumidifier, though some degree of cooling continues. The fan speed is not adjustable. Fan only mode: <ul style="list-style-type: none"> Use when cooling is not desired, such as for room air circulation or to exhaust stale air. (Remember to open the vent during this function, but keep it closed during cooling, for maximum cooling efficiency). Fan speed is selectable, but temperature is not affected.
6	(Up) and (Down) buttons	Press the (Up) or (Down) button to change the temperature setting. Press or press and hold either the (Up) or (Down) button until the desired temperature is shown on the display. This temperature will be automatically maintained anywhere between 60° F (16° C) and 86° F (30° C).

#	Item	Description
7	FAN button and indicator LEDs	Press to change the fan speed. The LEDs indicate the speed selected. Fan speed is adjusted in four steps - Auto > Low > Med > High. Each time the button is pressed, the next speed is selected. In fan mode, you can read the actual room temperature.
8	SLEEP button and indicator LED	Press to turn sleep mode on (LED on) or off (LED off). In this mode the selected temperature will increase (in cooling mode) by 2° F, 30 minutes after the mode is selected. The temperature will then increase (in cooling mode) by another 2° F, after an additional 30 minutes. This new temperature will be maintained for seven hours before Sleep mode ends and your air conditioner resumes normal operation. Sleep mode can be canceled at any time by pressing the SLEEP button again.
9	SWING button and indicator LED	Press to initiate the auto swing feature. When auto swing is ON, press the SWING button to stop the louver at the desired angle. Press and hold the SWING button for three seconds to initiate the filter reminder. This automatically reminds you (the LED above the button turns on) to clean the air filter after 250 hours of operation.
10	⏻ (power) button	Press to turn your air conditioner on or off. The Energy Saver function is automatically initiated in Cool, Dry, and Auto modes.

Remote control

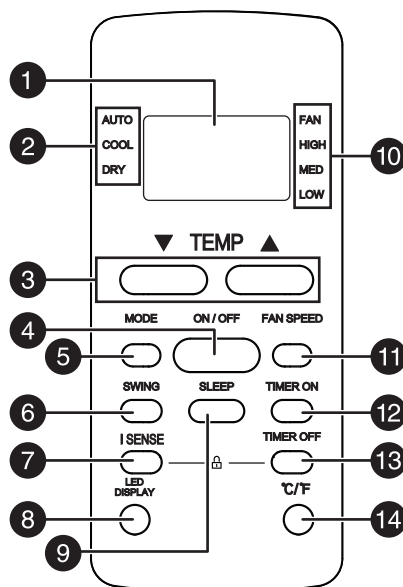







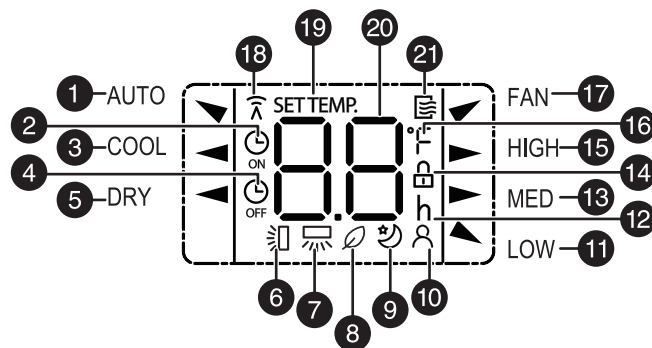



#	ITEM	DESCRIPTION
1	88°F (temperature/time) indicator 0h	Displays the room temperature or the set temperature. In Timer mode, displays the time.
2	Mode indicator	Indicates your air conditioner mode selected.
3	TEMP ▼ TEMP ▲ buttons	Press to lower or raise the temperature setting. In Timer mode, press to decrease or increase the time.
4	ON / OFF button	Press to turn your air conditioner on or off.
5	MODE button	Press to cycle through the available air conditioner modes, including AUTO>COOL>DRY.
6	SWING button	Press to turn on the horizontal louver movement. Press and hold (two seconds) to turn on the vertical louver movement. Press again to turn off the louver movement.
7	I SENSE button	Press to turn on the temperature sensing. Press and hold simultaneously with the TIMER OFF button for five seconds to lock the remote control buttons. To unlock the remote control buttons, press and hold simultaneously with the TIMER OFF button for two seconds
8	LED DISPLAY button	Press to turn on/off the display lighting and the control panel beep sound.

#	ITEM	DESCRIPTION
9	SLEEP button	Press to turn on sleep mode.
10	FAN speed indicator	Indicates the current fan mode.
11	FAN SPEED button	Press to cycle through the available fan speeds, including HIGH>MED>LOW.
12	TIMER ON button	Press to turn the timer on. If your air conditioner is on, sets the amount of time your air conditioner runs before it turns off. If your air conditioner is off, sets the amount of time you want your air conditioner to wait before it turns on.
13	TIMER OFF button	Press to turn the timer off. If your air conditioner is on, sets the amount of time your air conditioner waits before it turns off. If your air conditioner is off, sets the amount of time you want your air conditioner to stay off before it turns on. Press and hold simultaneously with the I SENSE button for five seconds to lock the remote control buttons. To unlock the remote control buttons, press and hold simultaneously with the I SENSE button for two seconds
14	°C/°F button	Press to select Celsius or Fahrenheit for the temperature display.

Remote control display screen



#	ITEM	DESCRIPTION
1	AUTO mode ▼ indicator	Lights when auto mode is selected.
2	Timer on  indicator	Lights when timer is on.
3	COOL mode ◀ indicator	Lights when cool mode is selected.
4	Timer off  indicator	Lights when timer is off.
5	DRY mode ◀ indicator	Lights when dry mode is selected.
6	Horizontal louver  swing indicator	Lights when the horizontal louver swing is on.
7	Vertical louver  swing indicator	All of the LEDs turn on when the remote is turned on, but this function is not available for this model.
8	Fresh feature  indicator	All of the LEDs turn on when the remote is turned on, but this function is not available for this model.
9	Sleep mode  indicator	Lights when sleep mode is turned on.
10	I SENSE mode  indicator	Lights when I SENSE mode is turned on.
11	LOW fan speed ▲ indicator	Lights when low fan speed is selected.
12	h	Lights when the timer mode is selected, to show the hour.
13	MED fan speed ▶ indicator	Lights when medium fan speed is selected.
14	Lock  indicator	Lights when the current settings (and remote control buttons) are locked.
15	HIGH fan speed ▶ indicator	Lights when high fan speed is selected.
16	°F indicator	Lights when Fahrenheit temperature display is selected.
17	FAN mode ▼ indicator	Lights when fan mode is selected.
18	DATA transmission  indicator	Lights when the remote control is transmitting data to your air conditioner.

#	ITEM	DESCRIPTION
19	SET TEMP indicator	Lights when the display shows the set temperature.
20	 (temperature/time) indicator	Displays the room temperature or set temperature. In Timer mode, displays the time.
21	Remote control on  indicator	Lights when the remote control is on.

Using the remote control

Notes:

- The remote control must be pointed at your air conditioner and used within 26.2 ft. (8 m).
- Your air conditioner will beep when the remote control signal is received.
- Curtains, other materials, and direct sunlight can interfere with the infrared signal receiver.

Installing the remote control batteries

Notes:

- Do not mix old and new batteries, or batteries of different types.
- Do not leave batteries in the remote control if you don't plan on using the device for more than two months.
- Do not dispose of batteries as unsorted municipal waste. Refer to local laws for proper disposal.

- 1 Slide the cover of the battery compartment off.

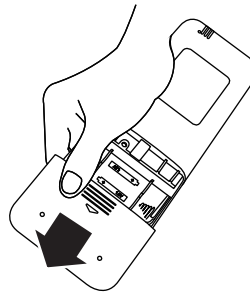

- 2 Insert two AAA (included) batteries. Make sure that the + and - symbols on the batteries match the symbols in the battery compartment.

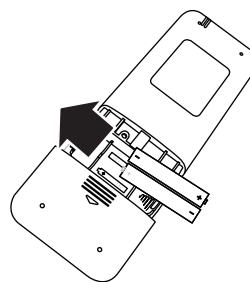

- 3 Reinstall the cover.

Before you mount your air conditioner

BEFORE YOU BEGIN

- Read these instructions completely and carefully.
- **IMPORTANT:** Save these instructions for local inspector's use.
- **IMPORTANT:** Observe all governing codes and ordinances.
- Note to Consumer: Keep these instructions for future reference.
- Note to Installer: Be sure to leave these instructions with the Consumer.
- Completion time: Approximately one hour.
- Skill level: Installation of this appliance requires basic mechanical skills.
- We recommend that two people install this product.
- Proper installation is the responsibility of the installer.
- Product failure due to improper installation is not covered under the Warranty.
- You **MUST** use all supplied parts and use proper installation procedures as described in these instructions when installing this air conditioner.
- If any piece of hardware is missing, **DO NOT INSTALL THE AIR CONDITIONER.** Call customer service.

Understanding the window requirements

Your air conditioner is designed to install in standard double hung windows with opening widths of 22-36 in. (55.9-91.4 cm) and a window height of 13.5 in. (34.3 cm). The lower sash must open sufficiently to allow a clear vertical opening of 13.7 in. (34.9 cm). Side louvers and the rear of the AC must have clear air space to allow enough airflow through the condenser for heat removal. The rear of the unit must be outdoors, not inside a building or garage.

Wooden windows

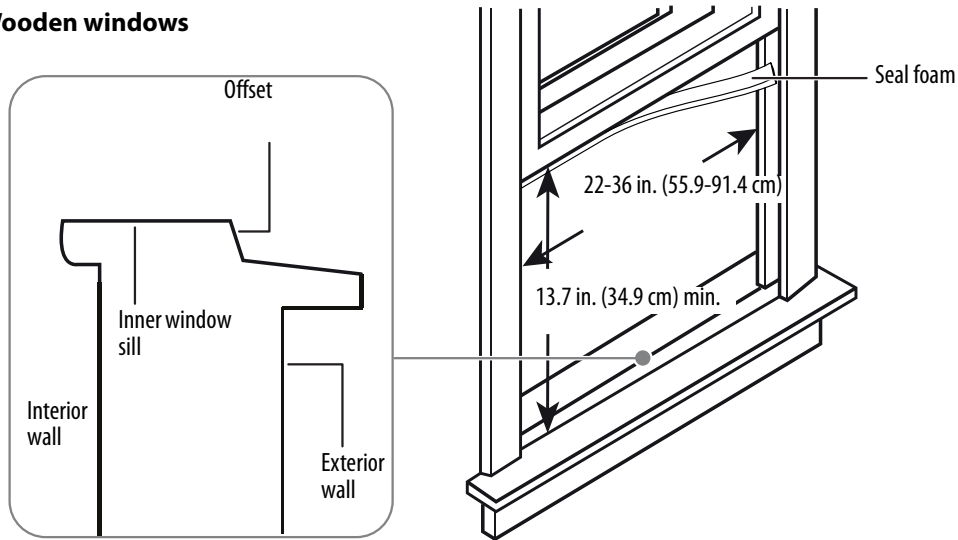

Vinyl-clad windows

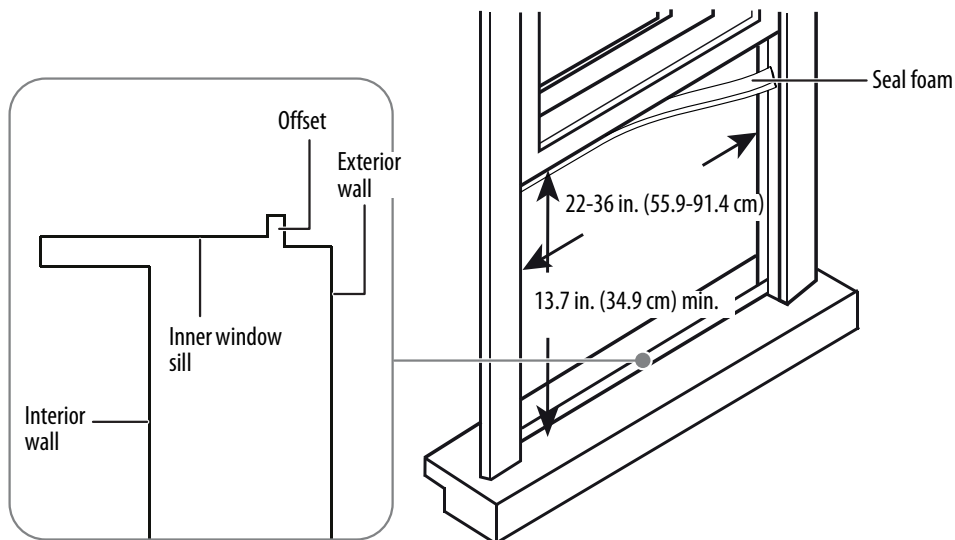

Dealing with storm windows

If a storm window blocks your air conditioner, remove it before installing your air conditioner. If the storm window cannot be removed:

- Make sure that the storm window's drain holes or slots are not caulked or painted shut. Accumulated rain water or condensation must be able to drain out.
- Attach a piece of wood across the entire window sill with nails or screws to correctly angle your air conditioner. Your air conditioner should be tilted back about 3–4° downward toward the outside. After proper installation, condensate should not drain from the overflow drain hole during normal use. If it does, adjust the angle of your air conditioner.
- You must secure the support bracket to the added wood piece using the provided 1" type A screws. Refer to [Step 2: Installing the support bracket](#) on page 18.

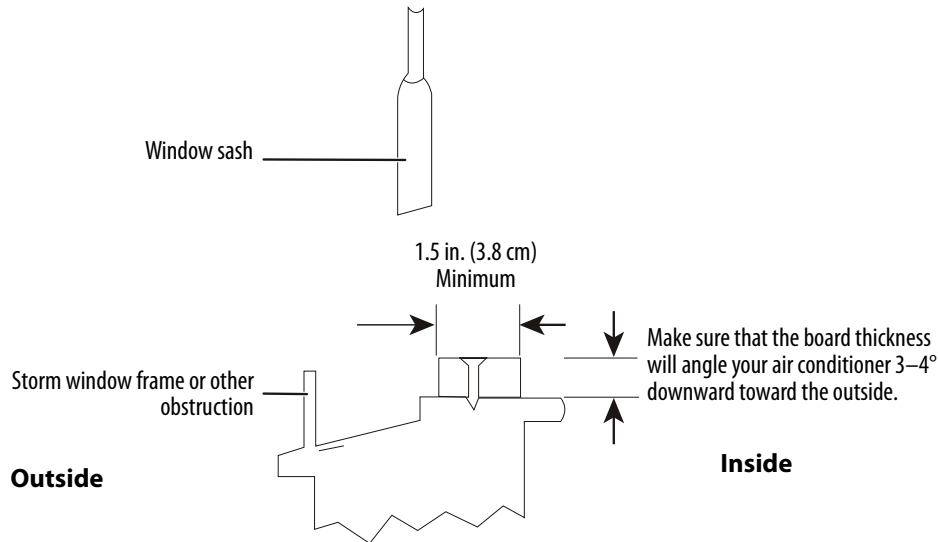

Installing your air conditioner

Step 1: Preparing the support bracket

- 1 Remove your air conditioner, support bracket, and hardware from the box and place on a flat surface.
- 2 Remove the packing material.
- 3 Find the center of your window and lightly mark it with a pencil.
- 4 Press the left spring push pin and adjust the left extension arm out, then do the same for the right extension arm.

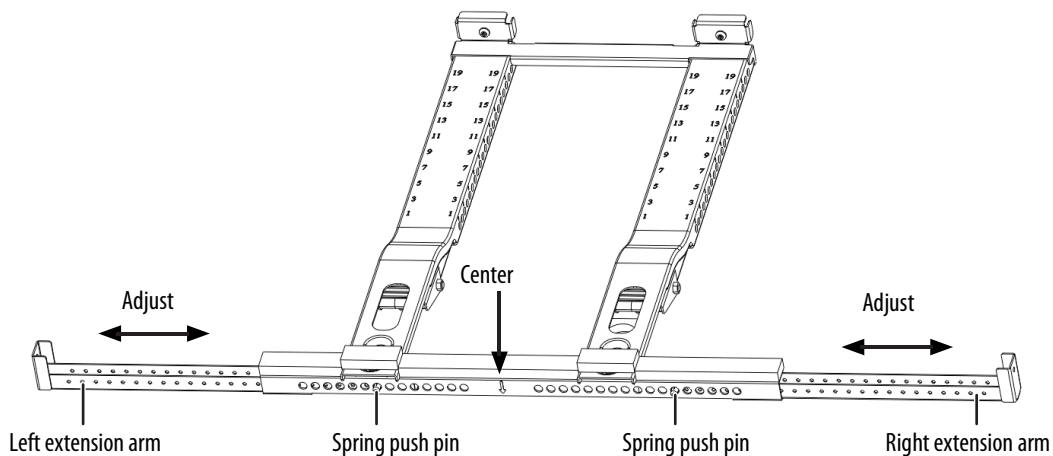

- 5 Measure the width of the inner windowsill. Making sure that the center of the support bracket lines up with the center of the window, then adjust the extension arms to the width you just measured. The support bracket will be offset to the left when centered.

- 6 Cut bracket sealing foam strips to length and apply to the bottom of the bracket.

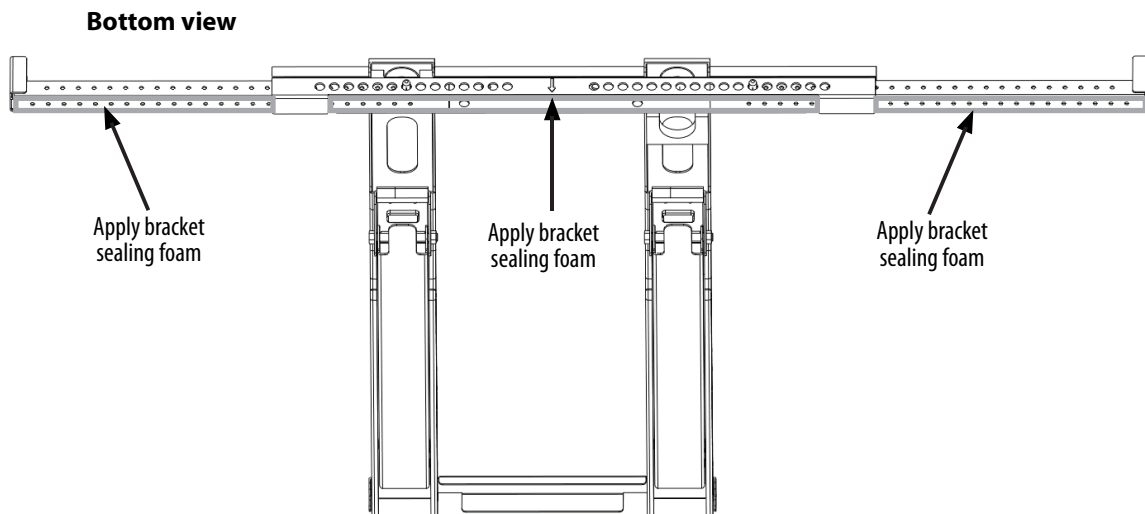

Step 2: Installing the support bracket

CAUTION: Maintain control of the bracket until the installation is complete.

- 1 Open the window where your air conditioner is being installed.
- 2 Place the main support bracket into the window opening, making sure that the horizontal bracket and extension arms are located on the indoor side of the window.

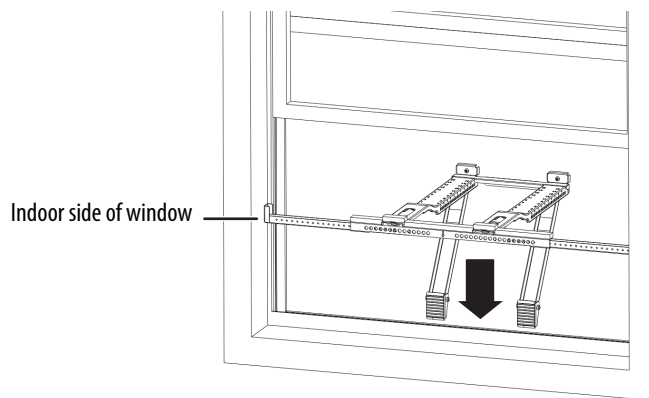

- 3 Lower the bracket until it rests on the windowsill.

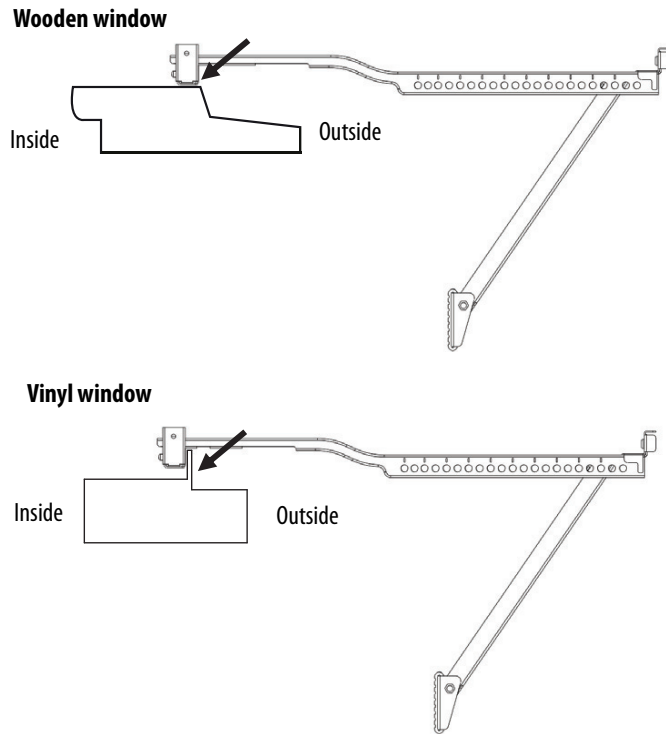

- 4 For wooden windows with a flat sill, secure the bracket to the windowsill by drilling 1/8 in. pilot holes and securing the bracket to the window with the 1/2" and 1" type A screws.

Note: If the gap between the bracket and the window sill exceeds 3/16 in. (5 mm), the bracket may be deformed while securing the 1" type A screws, you can add a block to reduce the gap if possible.

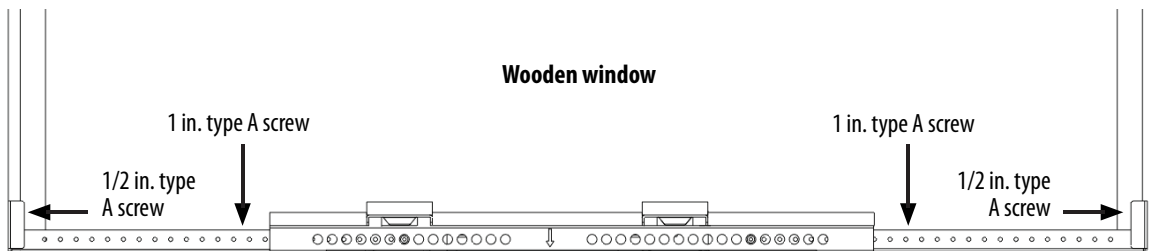

OR

- For vinyl windows with a flat sill, secure the bracket to the windowsill by drilling 1/8 in. pilot holes and securing the bracket to the window with the 1/2" type A screws.

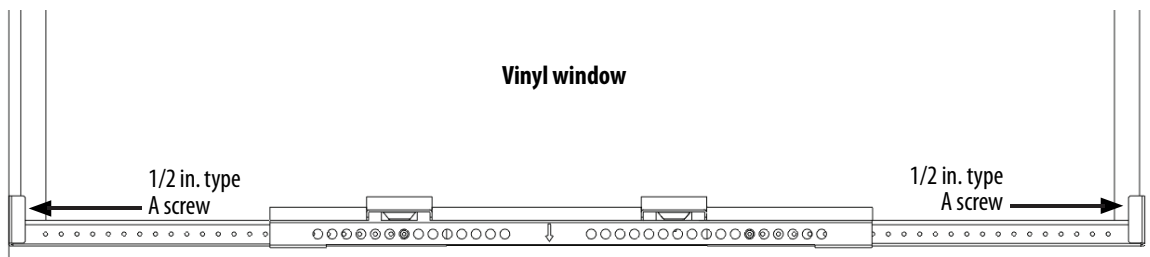

- 5 Move the angled support arms toward the exterior wall until the feet touch the wall. Place a level on the bracket and adjust the support arms so that it is level or tilted 1/4 bubble downward and towards the outside.

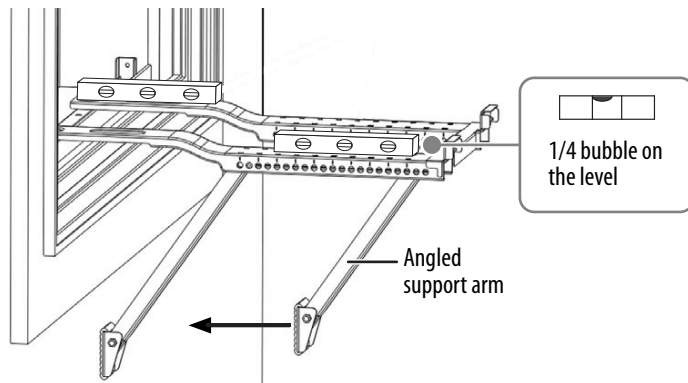

- 6 Insert the main support pin through the holes in the main support and angled support arm.

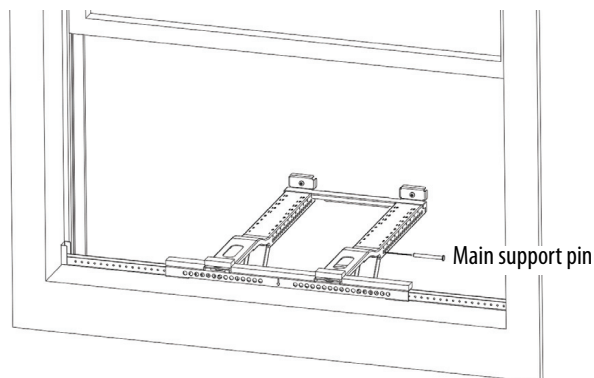

- 7 Using the numbers on the main support, repeat the adjustment for the other angled support arm matching the hole number from the first support arm.
- 8 Check the level again and make sure that the bracket is secure. If further adjustment is required, use alternate holes where the main supports attach to the horizontal bracket.

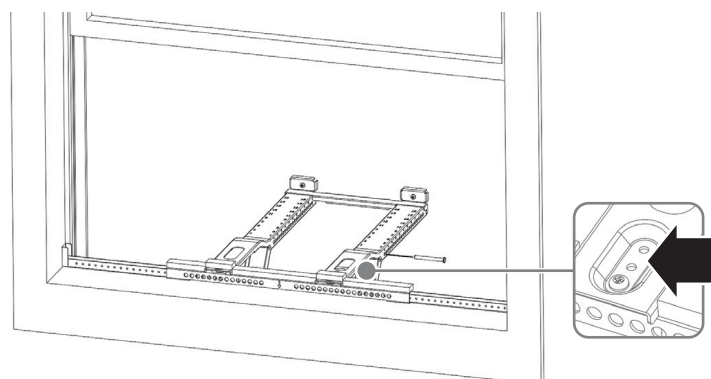

- 9 After making any final adjustments, insert the two cotter pins into the main support pin on both support brackets.

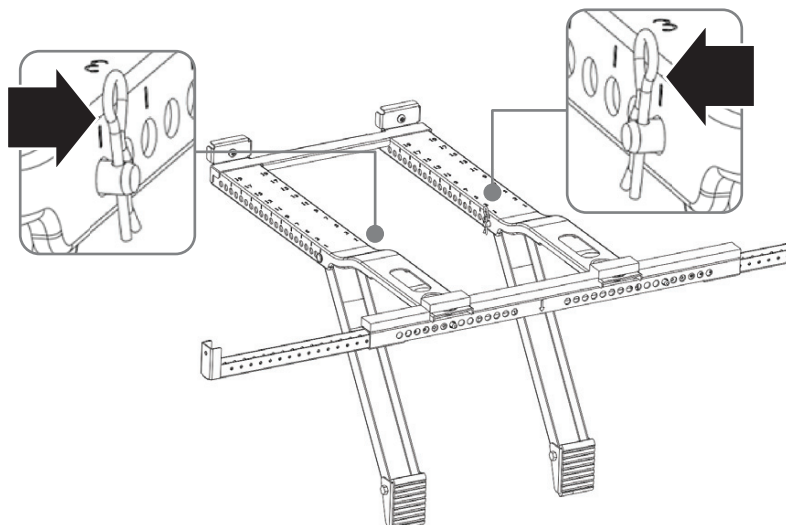

- 10 If necessary, cover the holes on the front of the bracket with bracket sealing foam.

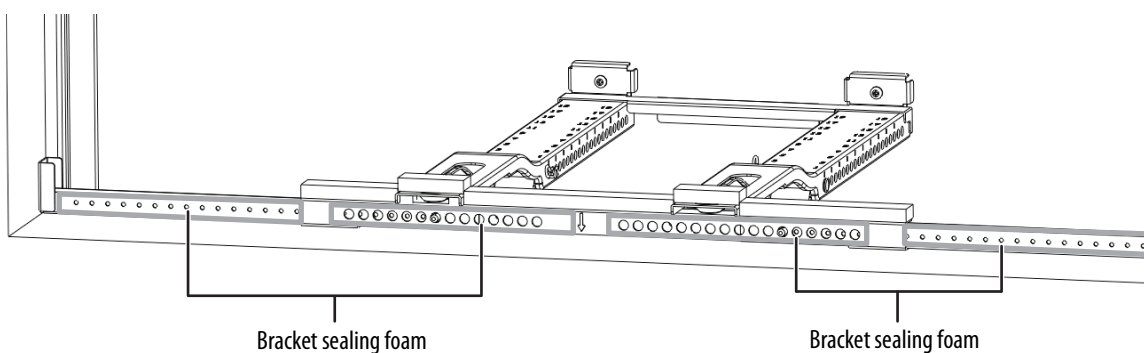

Step 3: Installing your air conditioner on the support bracket

CAUTION: Do not leave your air conditioner unattended during installation.

- 1 Measure the width of your window track (the vertical track your window slides up and down in). If it measures 1/2" or less, flip the anti-tip bracket so that the small end faces out, then continue with your air conditioner installation.

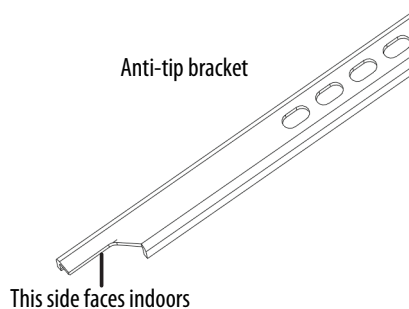

- 2 Set your air conditioner on top of the support bracket, making sure that the grooves on the bottom of your air conditioner align with the main supports. Using a level, check for proper tilt towards the outside.

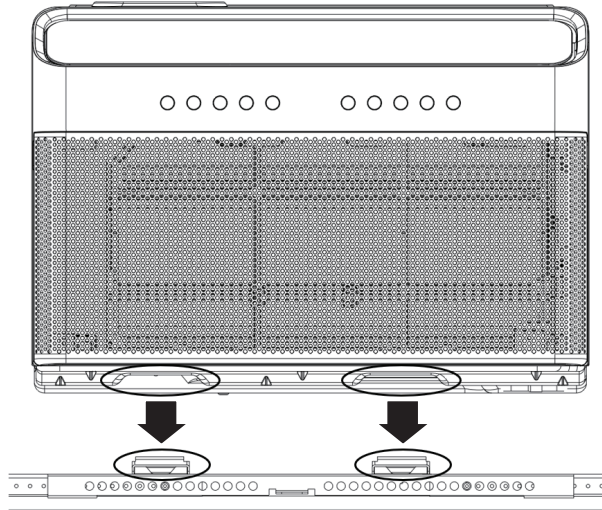

- 3 Pull the window down into the slot on top of your air conditioner to help align it correctly. Keep the window partially inserted into the slot to help support your air conditioner during installation.

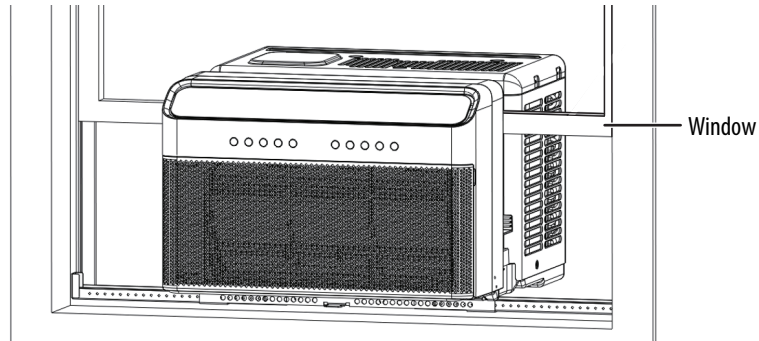

- 4 Fold down both side arm hinges.

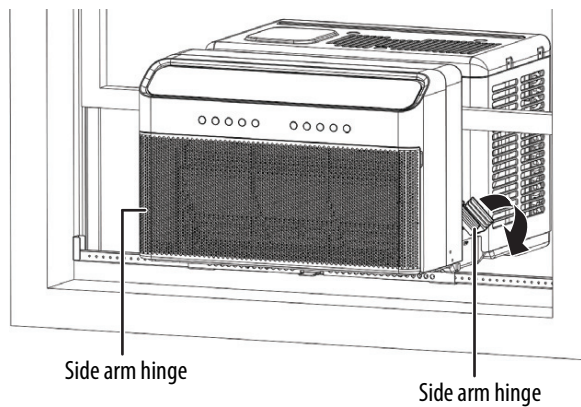

- 5 Using 1/4 in. and 1/2 in. type B screws, install the open window brackets with an "L" shaped screwdriver, if needed.

WARNING: Failure to install the open window brackets could cause injury or property damage.

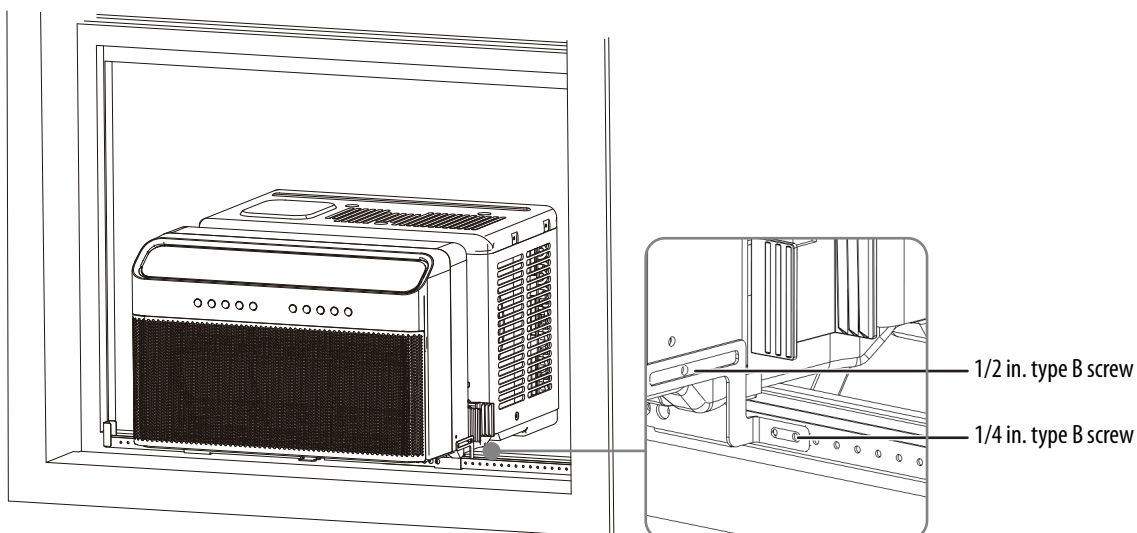

Step 4: Installing the sealing foam and anti-tip brackets

CAUTION: Do not leave your air conditioner unattended during installation.

- 1 Measure the distance between the right side arm hinge and the closest part of the window frame. Add 1/4 in. to this distance and cut the side arm foam block to width.

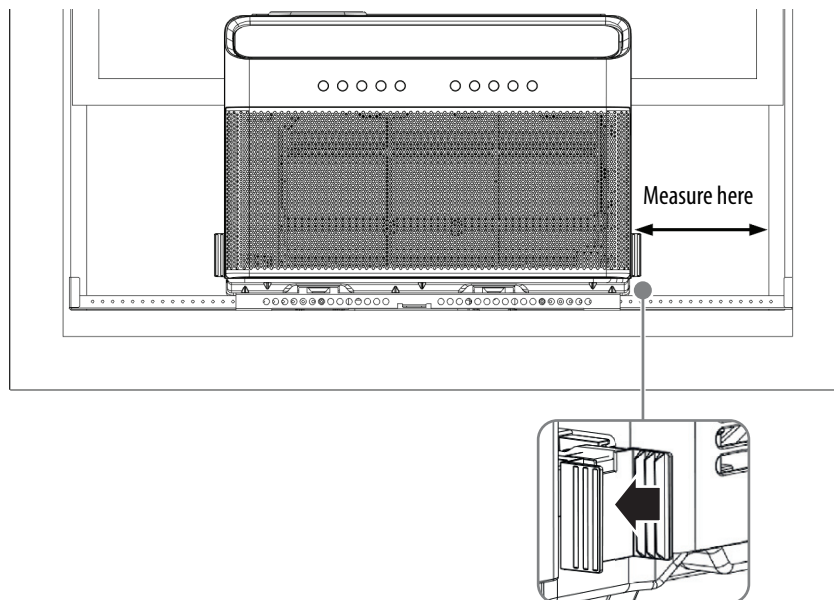

- 2 Apply window sealing foam to the side arm foam block as shown. Note that the window sealing foam attaches to the side next to your air conditioner.

Wooden window with flat sill

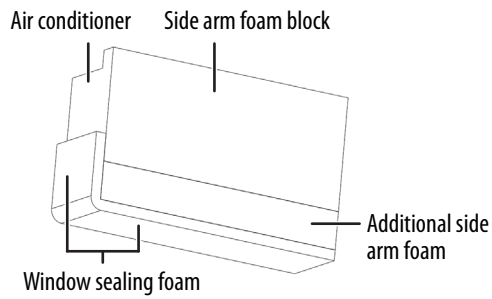

Vinyl window with lipped sill

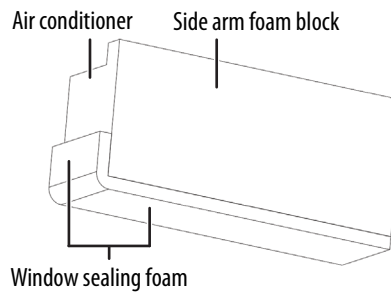

- 3 Insert a side arm foam block into the side arm hinge until the top front of the side arm foam is flush with the top of the hinge.

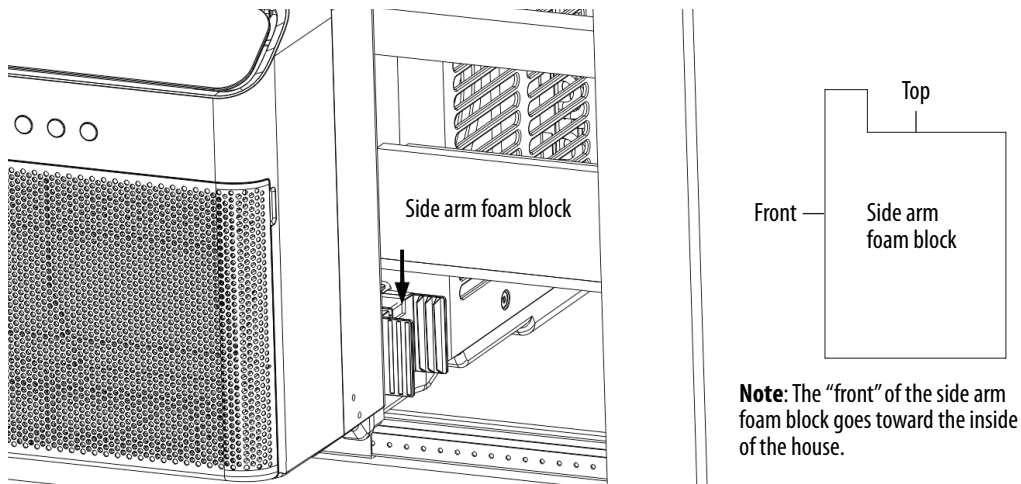

- 4 Repeat steps 1 through 3 for the left side of your air conditioner.
- 5 Remove the two 1/2 in. screws from the top left and right sides of your air conditioner.

CAUTION: The factory installed 1/2 in. screws must be re-used to secure the anti-tip brackets. Failure to use these screws could result in damage to your air conditioner.

- 6** Extend the anti-tip brackets (one on each side of your air conditioner) into the window tracks (the vertical track in which your window slides up and down) until they stop.

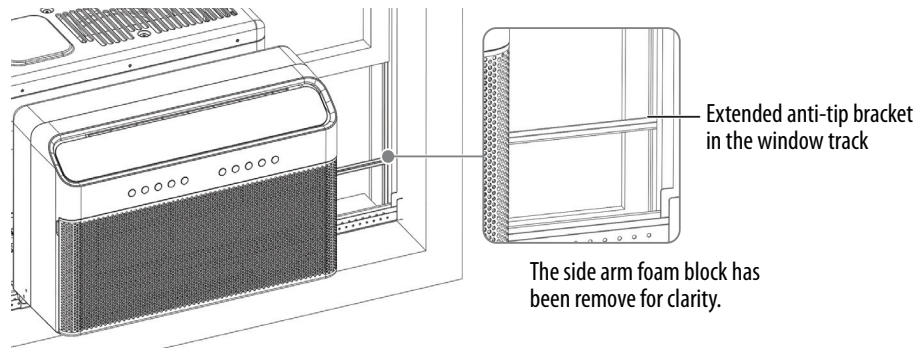

- 7** Secure the brackets in place using the screws you removed.

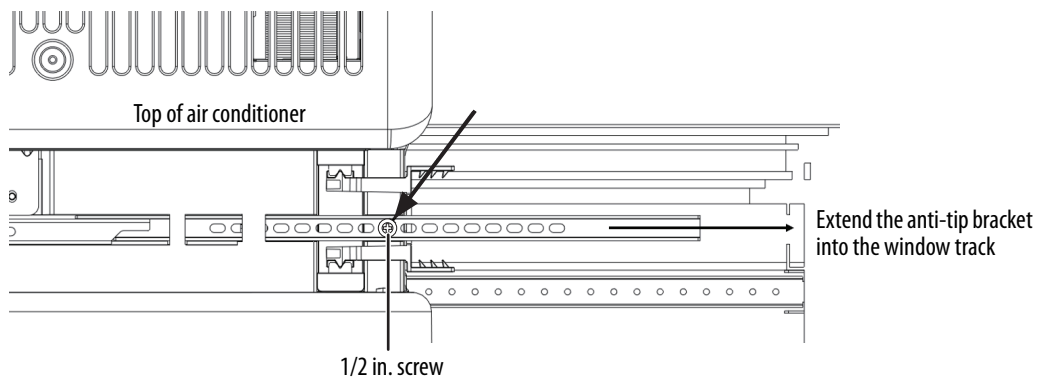

- 8** Install a strip of window sealing foam to the bottom of your lower window sash, sealing any small gaps between the window and your air conditioner, then close the window and check for gaps.
- 9** Fill any gaps with the included foam, as needed.
- 10** Extend the integrated window locks (located in the U channel) until they contact the window. For additional security, you can install the optional sash lock.

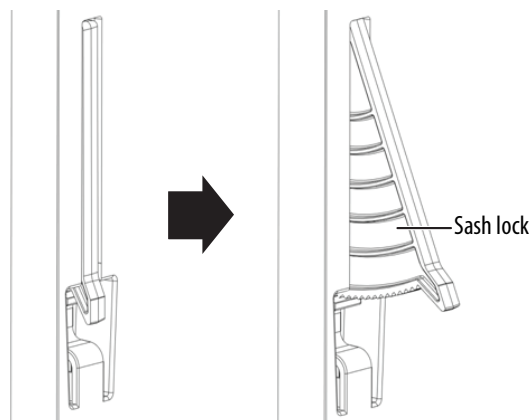

- 11** To secure the lower sash in place, attach the right angle sash lock with 1/2 in. type A screws.

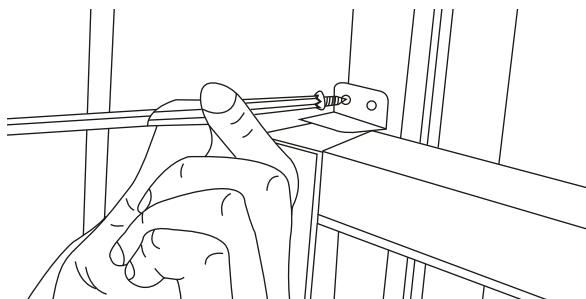

12 Cut strips of window sash foam and insert them in the space between the upper and lower sashes.

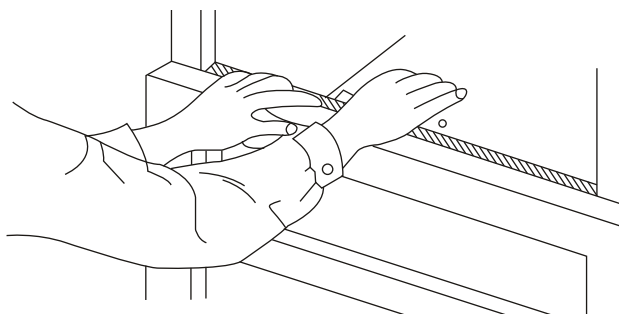

13 As a final check, review the installation and check for any gaps or openings. Seal any gaps with additional sealing foam (provided), to make sure that there are no leaks.

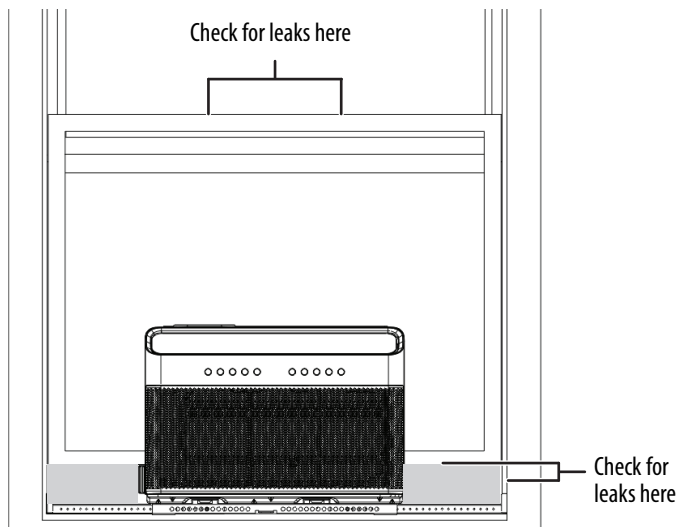

Using your air conditioner

Notes:

- If your air conditioner turns off unexpectedly due to a power outage, it will automatically restart with the previous settings when the power resumes.
- The cooling circuit has an automatic three minute delay if your air conditioner is turned off and on quickly. This prevents overheating of the compressor and possibly tripping the circuit breaker. The fan continues to run during this time.
- The relative humidity of the room should be less than 80%. If the unit is used in a condition with a relative humidity over 80%, water will condense on the surface of your air conditioner.
- For optimum performance, outdoor temperatures should be from 64° F to 109° F (18° C to 43° C), and indoor temperatures should be from 60° F to 90° F (16° C to 32° C).

You can control your air conditioner by using the control panel on the front of the unit or by using the remote control. If using the remote control, always point it at the control panel on your air conditioner.

Using your air conditioner for the first time

- 1 Plug in your air conditioner (be sure to follow the power cord instructions on page 4).
- 2 Turn the power on to your air conditioner using the ON/OFF button.
- 3 Select the Cool mode setting.
- 4 Adjust the louvers for comfortable air flow (see [Controlling air flow](#) on page 29).
- 5 Make sure that the air flow, both inside and outside, is not obstructed.
- 6 Once the room has cooled, adjust the thermostat to a comfortable setting.

Turning your air conditioner on/off

Plug in your air conditioner, then press  on your air conditioner, or **ON/OFF** on your remote control, to turn your air conditioner on or off.

Selecting an air conditioner mode

Press the **MODE** button repeatedly, on your air conditioner or your remote control, to cycle through Auto, Cool, Dry, and Fan modes. An indicator lights to show which mode is selected.

- **Auto:** Your air conditioner automatically selects cooling or fan, depending on the temperature you have selected and the room temperature. Fan speed cannot be adjusted, and it starts or stops based on the room temperature. You can adjust the temperature setting up to 86° F (30° C) or down to 60° F (16° C). The display shows the set temperature.
- **Cool:** Your air conditioner cools your room, with the compressor turning on and off and the fan remaining on to maintain the temperature you have selected. You can adjust the temperature setting up to 86° F (30° C) or down to 60° F (16° C). The display shows the set temperature.
- **Dry:** Your air conditioner operates as a dehumidifier. Some degree of cooling may occur as well.
- **Fan:** Your air conditioner circulates or exhausts air but does not cool the room. The display shows the actual room temperature, not our set temperature.

Selecting the fan speed

Press the **FAN** button repeatedly to cycle through the available fan speeds. Choices include Auto, Low, Med, or High. In Dry mode, the fan speed is set to Low automatically.

Using ECO (energy saver) mode

While using the ECO mode, the fan runs for three minutes after the compressor shuts off, then cycles on for two minutes at 10-minute intervals. When the room temperature is above the set temperature, the compressor turns back on and starts cooling again.

- Press the **ECO** button on your air conditioner to turn on ECO mode when using Cool, Dry, or Auto (auto-cooling or auto-fan) modes.



Note: Your air conditioner automatically initiates ECO mode in the Cool, Dry, and Auto (auto-cooling or auto-fan) modes.

Setting the timer

The combined on/off timer lets you automatically start and stop your air conditioner after a set amount of time. You can set Timer On to Off or Timer Off to On using your air conditioner control panel or the remote control.

Timer On

Set the timer to automatically turn on your air conditioner after a set time.

- 1 Press the **TIMER** button on your air conditioner, or **TIMER ON** on the remote control, until the Timer On LED or  (on the remote control) lights.
- 2 To set how long to wait before your air conditioner turns on, press  /  (up/down arrows) to adjust the delay time from 0.5–10 hours in half-hour increments, then 10–24 hours in one-hour increments. Your air conditioner starts running after the timer counts down from the set time.

- Using the control panel, the setting is automatically saved after five seconds.
OR
- Point the remote control at your air conditioner unit and the setting is saved after one second.

Note: To cancel the timer program, set the timer to **0:0** hours on the control panel. Your air conditioner turns off.

Timer Off

Set the timer to automatically turn off your air conditioner after a set time.

- 1 Press the **TIMER** button on your air conditioner, or **TIMER OFF** on the remote control, until the Timer Off LED or  (on the remote control) lights.
- 2 To set how long you want your air conditioner to run, press **▲ / ▼** (up/down) to adjust the delay time from 0.5–10 hours in half-hour increments, then 10–24 hours in one-hour increments. Your air conditioner stops running after the timer counts down from the set time.
 - Using the control panel, the setting is automatically saved after five seconds.
OR
 - Point the remote control at your air conditioner unit and the setting is saved after one second.

Note: To cancel the timer program, set the timer to **0:0** hours on the control panel. Your air conditioner turns on.

Timer On to Off

Set Timer On to Off to automatically turn your air conditioner on, then back off, after a set time.

- 1 Press **TIMER ON** until the Timer Off LED lights.
- 2 To set how long to wait before your air conditioner turns on, press **▲ / ▼** (up/down) to adjust the delay time from 0.5–10 hours in half-hour increments, then 10–24 hours in one-hour increments.
- 3 Press **TIMER ON** again. The number next to Timer Off blinks.
- 4 To set how long you want your air conditioner to run, press **▲ / ▼** (up/down) to adjust the delay time from 0.5–10 hours in half-hour increments, then 10–24 hours in one-hour increments. The setting is automatically saved after pointing the remote control at your air conditioner for one second. Your air conditioner starts when the Timer On time elapses, then turns off again after the Timer Off time elapses.

Note: To cancel the timer program, set the timer to 0.0 h.

Timer Off to On

Set Timer Off to On to automatically turn your air conditioner off, then back on, after a set time.

- 1 Press **TIMER OFF** until the number next to Timer Off blinks.
- 2 To set how long you want your air conditioner to run, press **▲ / ▼** (up/down) to adjust the delay time from 0.5–10 hours in half-hour increments, then 10–24 hours in one-hour increments.
- 3 Press **TIMER OFF** again. The number next to Timer On blinks.
- 4 To set how long to wait before your air conditioner turns on, press **▲ / ▼** (up/down) to adjust the delay time from 0.5–10 hours in half-hour increments, then 10–24 hours in one-hour increments. The setting is automatically saved after pointing the remote control at your air conditioner for one second. Your air conditioner turns off when the Timer Off time elapses, then turns on again after the Timer On time elapses.

Note: To cancel the timer program, set the timer to 0.0 h.

Using the remote as a thermostat (I SENSE)

The remote control can function as a remote thermostat for precise temperature control at its location.

- To turn on the I SENSE feature, aim the remote control toward your air conditioner and press **I SENSE**. The remote displays the temperature at its actual location and sends a signal to your air conditioner every three minutes.
 - Note:** I SENSE can only be turned on with the remote control.
- To turn off I SENSE, press **I SENSE** again.



Note: Make sure that the remote control is turned toward the air conditioner when I SENSE is on, and there should be no obstacle between the remote control and the air conditioner. If your air conditioner does not receive the I SENSE signal during any 7-minute interval, your air conditioner beeps to indicate that I SENSE mode has ended.

Using the check filter reminder

- The check filter indicator lights (the LED above the **SWING** button on your air conditioner) automatically after 250 hours of operation. See [Cleaning the air filter](#) on page 30.
- To reset after cleaning the filter, press and hold the **SWING** button for three seconds. The light turns off.

Using sleep mode

During Sleep mode, the temperature will increase by 2° F (1–2° C) 30 minutes after the mode is selected, then increase by another 2° F (1–2° C) after an additional 30 minutes. This new temperature is maintained for 6–7 hours, then Sleep mode turns off. Your air conditioner cools to the original temperature and continues to operate as first programmed.

- Press the **SLEEP** button to turn on sleep mode. The sleep indicator on your air conditioner, or  on the remote control lights.
- To turn off Sleep mode, press the **SLEEP** button again. The sleep indicator on your air conditioner, or  on the remote control turns off.

Turning the display on or off

Press the LED button on your air conditioner, or the **LED DISPLAY** button on your remote control, to turn your air conditioner display on or off.

Locking air conditioner settings

- Press **I SENSE** and **TIMER OFF** for five seconds to lock the remote control's settings so that they cannot be changed. Press **I SENSE** and **TIMER OFF** for two seconds again to unlock the remote control.

Controlling air flow

The louvers on the front of your air conditioner let you direct the air flow up or down and left or right throughout the room as needed. Press the **SWING** button until the desired up/down direction is obtained. Move the louvers from side to side until the desired left/right direction is obtained.

Note: The up/down louvers cannot be adjusted manually.

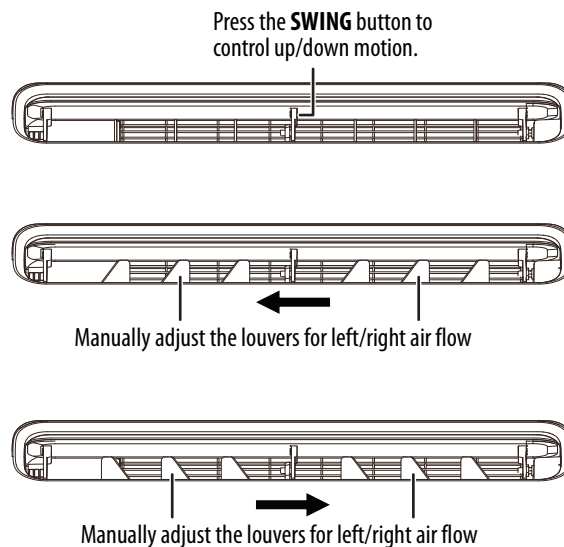

Understanding sounds

These sounds are part of your air conditioner's normal operation.

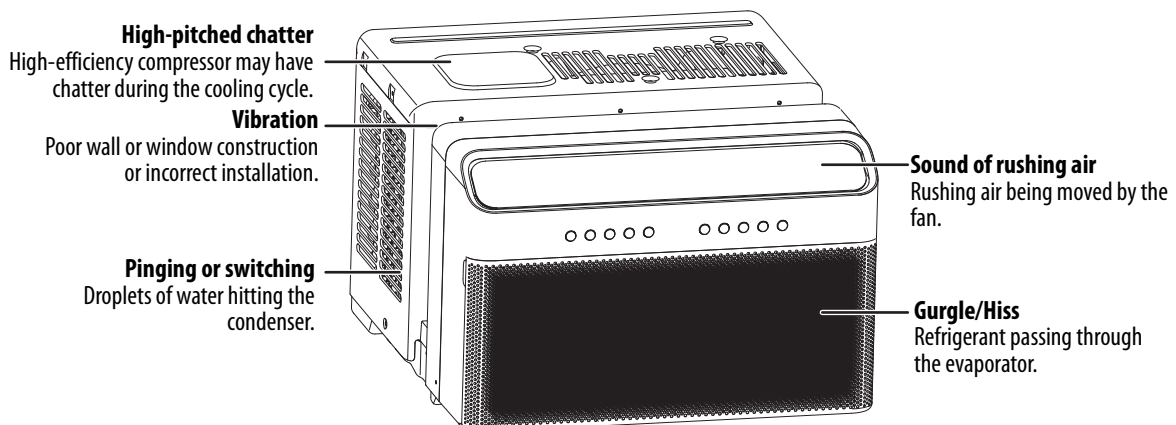

Cleaning and maintaining your air conditioner

CAUTION: Unplug your air conditioner before cleaning to prevent shock or fire hazards.

Cleaning the cabinet

- Dust the cabinet and front with an oil-free cloth, or wash with a cloth dampened in a solution of warm water and mild liquid dish-washing detergent. Rinse thoroughly and wipe dry.
- Never use harsh cleaners, wax, or polish on the cabinet.
- Make sure that you wring excess water from the cloth before wiping around the controls. Excess water in or around the controls can damage your air conditioner.

Cleaning the air filter

Note: Never use hot water over 104° F (40° C) to clean the air filter. Never attempt to use your air conditioner without the air filter.

- 1 Open the front panel of your air conditioner.
- 2 Grasp the center of the filter, then pull up and out.
- 3 Wash the filter with warm water, then rinse thoroughly. Gently shake excess water from the filter, and let it air dry. Make sure that the filter is thoroughly dry before replacing it.
OR
Vacuum the filter to remove dust and other debris.

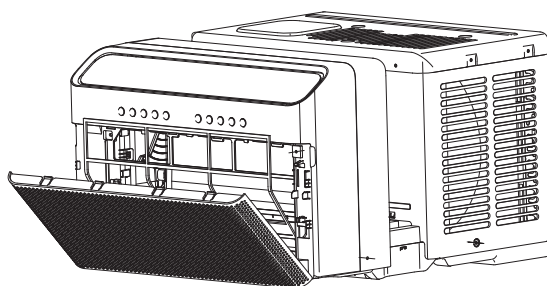

Storing your air conditioner

If you plan to store your air conditioner during the winter, remove it carefully from the window (see [Removing your air conditioner from the window](#) on page 30) and cover it with plastic or return it to its original box.

Removing your air conditioner from the window

- 1 Turn your air conditioner off, and disconnect the power cord.
- 2 Remove the sash sealing foam from between the windows, then unscrew the safety sash lock.
- 3 Retract the integrated window locks, if used.
- 4 Remove the screws and retract the anti-tip brackets.
- 5 Remove the side arm foam blocks from both sides of your air conditioner.
- 6 Keeping a firm grip on your air conditioner, raise the window sash and carefully remove your air conditioner.

Note: Be careful not to spill any remaining water while lifting your air conditioner from the window. Store parts with your air conditioner.

Troubleshooting

PROBLEM	POSSIBLE CAUSE	POSSIBLE SOLUTION
My air conditioner does not start.	The wall plug is disconnected.	Push the plug firmly into a wall outlet.
	The house fuse is blown or circuit breaker is tripped.	Replace the fuse with a time-delay-type fuse or reset the circuit breaker.
	The plug current device is tripped.	Press the RESET button.
	The power is off.	Turn the power on.
Air does not feel cold enough.	The room temperature is below 60° F (16° C).	Cooling may not occur until room temperature rises above 60° F (16° C).
	The temperature sensor behind the air filter is touching a cold coil.	Make sure that the temperature sensor does not touch a coil.
	The temperature is set too high.	Lower the set temperature.
	The compressor stopped when changing modes.	Wait three minutes after changing the mode.
My air conditioner is cooling, but the room is too warm. Ice is forming on the cooling coil behind the decorative front.	Outdoor temperature is below 64° F (18° C).	To defrost the coil, turn on Fan mode.
	The air filter is dirty.	Clean the filter. See Cleaning the air filter on page 30.
	The thermostat is set too cold for nighttime cooling.	To defrost the coil, turn on Fan mode, then set the temperature to a higher setting.
My air conditioner is cooling, but the room is too warm. No ice is forming on the cooling coil behind the decorative front.	The air filter is dirty, restricting airflow.	Clean the filter. See Cleaning the air filter on page 30.
	The temperature is set too high.	Lower the set temperature.
	Air directional louvers are positioned improperly.	Position the louvers for better air distribution.
	The front of your air conditioner is blocked by drapes, blinds, or furniture, restricting air distribution.	Clear the blockage in front of your air conditioner.
	Doors, windows, or registers are open, allowing cold air to escape.	Close any open doors, windows, or registers.
	Your air conditioner recently turned on in a hot room.	Allow additional time to remove stored heat from the walls, ceiling, floor, and furniture.
My air conditioner turns on and off rapidly.	The air filter is dirty, restricting airflow.	Clean the filter. See Cleaning the air filter on page 30.
	The outside temperature is extremely hot.	Set the fan speed to a higher setting to bring air past the cooling coils more frequently.
There is noise when my air conditioner is cooling.	Air movement sound.	This is normal. If it is too loud, set the fan to a slower setting.
	The window is vibrating.	Check the installation instructions or with the installer to make sure that your air conditioner is correctly installed.
Water is dripping inside while my air conditioner is cooling.	Your air conditioner is not installed correctly.	Tilt your air conditioner slightly toward the outside to let the water drain outside. See Step 3: Installing your air conditioner on the support bracket on page 21.
Water is dripping outside while my air conditioner is cooling.	Your air conditioner is removing a large quantity of moisture from a humid room.	This is normal during excessively humid days.
Remote sensing (I SENSE) is deactivating prematurely.	The remote control is not within range.	Place the remote control within 26 ft. (8 m) and a 180° radius of the front of your air conditioner.
	The remote control signal is obstructed.	Remove the obstruction.

PROBLEM	POSSIBLE CAUSE	POSSIBLE SOLUTION
The room is too cold.	The set temperature is too low.	Raise the set temperature.
There is a chemical smell when it's first started.	New unit.	This is normal during initial use and will go away after some time.
The temperature fluctuates.	The compressor cycles on and off as the temperature drops.	This is normal.
There are gaps around my air conditioner.	Improper installation.	The gaps should have been filled with foam insulation strips during installation. See Step 4: Installing the sealing foam and anti-tip brackets on page 23.
There is a rattling sound.	Loose filter or damaged louvers.	<ul style="list-style-type: none"> • Make sure that the filter is installed correctly. • Check the louvers for damage. • Make sure that your air conditioner was installed correctly
An error code appears on the display.	Various	If an error code appears on the display, wait for about 10 minutes and the problem may resolve itself. If not, disconnect the power, then connect it again and turn your air conditioner on. If the error code repeats and the problem persists, disconnect the power and contact your nearest customer service center.

Specifications

Dimensions (H x W x D)	13.5 x 19.2 x 22 in. (34.2 x 48.7 x 55.8 cm)
Weight	53.1 lbs (24.1 kg)
Power requirements	720 W
Current	8.78 A
Annual energy cost	\$43.00
Cooling power (BTUs)	8,000
Volume	48 dBA
Environment temperature variance	60° F-90° F (16° C -32° C)
Power cord length	4.9 ft. (1.5 m)
Recommended room size	350 sq. ft. (32.5 sq. m)
Temperature setting range	60° F to 86° F (16° C to 30° C)

Legal notices

FCC and IC Information:

The device should comply with the local national regulations.

- In Canada, it should comply with CAN ICES-3(B)/NMB-3(B).
- In USA, this device complies with part 15 of the FCC Rules. Operation is subject to the following two conditions: (1) this device may not cause interference, and (2) this device must accept any interference, including interference that may cause undesired operation of the device.

This equipment has been tested and found to comply with the limits for a Class B digital device, pursuant to Part 15 of the FCC Rules. These limits are designed to provide reasonable protection against harmful interference in a residential installation. This equipment generates, uses, and can radiate radio frequency energy and, if not installed and used in accordance with the instructions, may cause harmful interference to radio communications. However, there is no guarantee that interference will not occur in a particular installation. If this equipment does cause harmful interference to radio or television reception, which can be determined by turning the equipment off and on, the user is encouraged to try to correct the interference by one or more of the following measures:

- Reorient or relocate the receiving antenna.
- Increase the separation between the equipment and receiver.
- Connect the equipment into an outlet on a circuit different from that to which the receiver is connected.
- Consult the dealer or an experienced radio/TV technician for help.

Warning: Changes or modifications not expressly approved by the party responsible for compliance could void the user's authority to operate the equipment.

This equipment complies with Industry Canada radiation exposure limits set forth for an uncontrolled environment.

California Residents

WARNING: Cancer and reproductive harm – www.p65warnings.ca.gov

ONE-YEAR LIMITED WARRANTY

Definitions:

The Distributor* of Insignia branded products warrants to you, the original purchaser of this new Insignia-branded product ("Product"), that the Product shall be free of defects in the original manufacturer of the material or workmanship for a period of one (1) year from the date of your purchase of the Product ("Warranty Period").

For this warranty to apply, your Product must be purchased in the United States or Canada from a Best Buy branded retail store or online at www.bestbuy.com or www.bestbuy.ca and is packaged with this warranty statement.

How long does the coverage last?

The Warranty Period lasts for 1 year (365 days) from the date you purchased the Product. Your purchase date is printed on the receipt you received with the Product.

What does this warranty cover?

During the Warranty Period, if the original manufacture of the material or workmanship of the Product is determined to be defective by an authorized Insignia repair center or store personnel, Insignia will (at its sole option): (1) repair the Product with new or rebuilt parts; or (2) replace the Product at no charge with new or rebuilt comparable products or parts. Products and parts replaced under this warranty become the property of Insignia and are not returned to you. If service of Products or parts are required after the Warranty Period expires, you must pay all labor and parts charges. This warranty lasts as long as you own your Insignia Product during the Warranty Period. Warranty coverage terminates if you sell or otherwise transfer the Product.

How to obtain warranty service?

If you purchased the Product at a Best Buy retail store location or from a Best Buy online website (www.bestbuy.com or www.bestbuy.ca), please take your original receipt and the Product to any Best Buy store. Make sure that you place the Product in its original packaging or packaging that provides the same amount of protection as the original packaging.

To obtain warranty service, in the United States and Canada call 1-877-467-4289. Call agents may diagnose and correct the issue over the phone.

Where is the warranty valid?

This warranty is valid only in the United States and Canada at Best Buy branded retail stores or websites to the original purchaser of the product in the country where the original purchase was made.

What does the warranty not cover?

This warranty does not cover:

- Food, beverage, and or medicine loss/spoilage.
- Customer instruction/education
- Installation
- Set up adjustments
- Cosmetic damage
- Damage due to weather, lightning, and other acts of God, such as power surges
- Accidental damage
- Misuse
- Abuse
- Negligence
- Commercial purposes/use, including but not limited to use in a place of business or in communal areas of a multiple dwelling condominium or apartment complex, or otherwise used in a place of other than a private home.
- Modification of any part of the Product, including the antenna
- Display panel damaged by static (non-moving) images applied for lengthy periods (burn-in).
- Damage due to incorrect operation or maintenance
- Connection to an incorrect voltage or power supply
- Attempted repair by any person not authorized by Insignia to service the Product
- Products sold "as is" or "with all faults"
- Consumables, including but not limited to batteries (i.e. AA, AAA, C etc.)
- Products where the factory applied serial number has been altered or removed
- Loss or Theft of this product or any part of the product
- Display panels containing up to three (3) pixel failures (dots that are dark or incorrectly illuminated) grouped in an area smaller than one tenth (1/10) of the display size or up to five (5) pixel failures throughout the display. (Pixel based displays may contain a limited number of pixels that may not function normally.)
- Failures or Damage caused by any contact including but not limited to liquids, gels or pastes.

REPAIR REPLACEMENT AS PROVIDED UNDER THIS WARRANTY IS YOUR EXCLUSIVE REMEDY FOR BREACH OF WARRANTY. INSIGNIA SHALL NOT BE LIABLE FOR ANY INCIDENTAL OR CONSEQUENTIAL DAMAGES FOR THE BREACH OF ANY EXPRESS OR IMPLIED WARRANTY ON THIS PRODUCT, INCLUDING, BUT NOT LIMITED TO, LOST DATA, LOSS OF USE OF YOUR PRODUCT, LOST BUSINESS OR LOST PROFITS. INSIGNIA PRODUCTS MAKES NO OTHER EXPRESS WARRANTIES WITH RESPECT TO THE PRODUCT, ALL EXPRESS AND IMPLIED WARRANTIES FOR THE PRODUCT, INCLUDING BUT NOT LIMITED TO ANY IMPLIED WARRANTIES OF AND CONDITIONS OF MERCHANTABILITY AND FITNESS FOR A PARTICULAR PURPOSE, ARE LIMITED IN DURATION TO THE WARRANTY PERIOD SET FORTH ABOVE AND NO WARRANTIES, WHETHER EXPRESS OR IMPLIED, WILL APPLY AFTER THE WARRANTY PERIOD. SOME STATES, PROVINCES AND JURISDICTIONS DO NOT ALLOW LIMITATIONS ON HOW LONG AN IMPLIED WARRANTY LASTS, SO THE ABOVE LIMITATION MAY NOT APPLY TO YOU. THIS WARRANTY GIVES YOU SPECIFIC LEGAL RIGHTS, AND YOU MAY ALSO HAVE OTHER RIGHTS, WHICH VARY FROM STATE TO STATE OR PROVINCE TO PROVINCE.

Contact Insignia:

1-877-467-4289

www.insigniaproducts.com

INSIGNIA is a trademark of Best Buy and its affiliated companies.

*Distributed by Best Buy Purchasing, LLC

7601 Penn Ave South, Richfield, MN 55423 U.S.A

©2022 Best Buy. All rights reserved.

INSIGNIA™

For product inquiries, please contact us with the information below:

1-877-467-4289

www.insigniaproducts.com

INSIGNIA is a trademark of Best Buy and its affiliated companies.

Distributed by Best Buy Purchasing, LLC

7601 Penn Ave South, Richfield, MN 55423 U.S.A.

©2022 Best Buy. All rights reserved.

V1 ENGLISH
21-0893