

GARMIN®

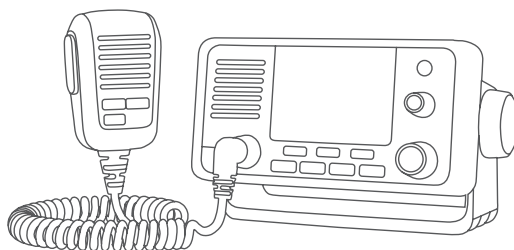

VHF 115/VHF 215/VHF 215 AIS SERIES INSTALLATION INSTRUCTIONS

Important Safety Information

⚠ WARNING

See the *Important Safety and Product Information* guide in the product box for product warnings and other important information.

⚠ CAUTION

Always wear safety goggles, ear protection, and a dust mask when drilling, cutting, or sanding.

NOTICE

When drilling or cutting, always check what is on the opposite side of the surface to avoid damaging the vessel.

Mounting Considerations

NOTICE

This device should be mounted in a location that is not exposed to extreme temperatures or conditions. The temperature range for this device is listed in the product specifications. Extended exposure to temperatures exceeding the specified temperature range, in storage or operating conditions, may cause device failure. Extreme-temperature-induced damage and related consequences are not covered by the warranty.

When selecting a mounting location, you should observe these considerations.

- The location should provide optimal viewing as you operate your boat.
- The location should allow for easy access to all device interfaces, such as the keypad, touchscreen, and card reader, if applicable.
- The location must be strong enough to support the weight of the device and protect it from excessive vibration or shock.
- To avoid interference with a magnetic compass, the device should not be installed closer to a compass than the compass-safe distance value listed in the product specifications.
- The location must allow room for the routing and connection of all cables.
- When flush mounting the device, the location must not be a flat, horizontal surface. The location should be in a vertical angle.

The location and viewing angle should be tested before you install the device. High viewing angles from above and below the display may result in a poor image.



VHF Antenna Mounting and EME Exposure

⚠ WARNING

Radio operators with cardiac pacemakers, life-support machines, or electrical medical equipment should not be exposed to excessive radio-frequency (RF) fields, because the RF field may interfere with the function of their medical equipment.

⚠ CAUTION

This device generates and radiates radio frequency (RF) electromagnetic energy (EME). Failure to observe these guidelines may expose people to RF radiation absorption exceeding the maximum permissible exposure (MPE).

Garmin® declares an MPE radius of 2.48 m (97.64 in.) for this system, which was determined using 5 W output to an omni-directional, 6 dBi gain antenna. The antenna should be installed to maintain a distance of 2.48 m (97.64 in.) between the antenna and all people.

Bail Mounting the Device

NOTICE

If you are mounting the bracket on fiberglass with screws, it is recommended to use a countersink bit to drill a clearance counterbore through only the top gel-coat layer. This will help to avoid cracking in the gel-coat layer when the screws are tightened.

You can use the included bracket to bail mount the device on a flat surface.

1 Using the bail-mount bracket ① as a template, mark the pilot holes.

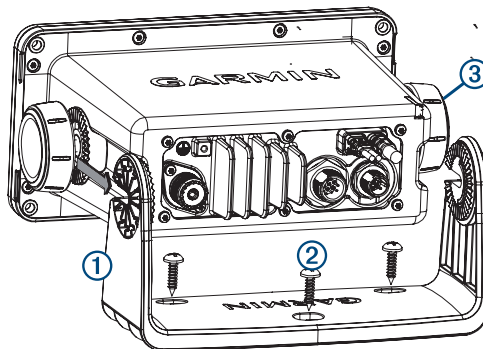

- 2 Using a 3.5 mm ($9/64$ in.) drill bit, drill the pilot holes.
- 3 Using the included screws ②, secure the bail-mount bracket to the mounting surface.
- 4 Install the bail-mount knobs ③ on the sides of the device.
- 5 Place the device in the bail-mount bracket and tighten the bail-mount knobs.

Flush Mounting the Device

NOTICE

Be careful when cutting the hole to flush mount the device. There is only a small amount of clearance between the case and the mounting holes, and cutting the hole too large could compromise the stability of the device after it is mounted.

If you are mounting the bracket on fiberglass with screws, it is recommended to use a countersink bit to drill a clearance counterbore through only the top gel-coat layer. This will help to avoid cracking in the gel-coat layer when the screws are tightened.

Before cutting or drilling to flush mount the device, be sure the space behind the mounting surface can accommodate the radio.

The included template and hardware can be used to mount the device in your dashboard.

- 1 Trim the template and make sure it fits in the location where you want to mount the device.
- 2 Using a 9.5 mm ($\frac{3}{8}$ in.) drill bit, drill one or more of the holes inside the corners of the solid line on the template to prepare the mounting surface for cutting.
- 3 Using a jigsaw or rotary tool, cut the mounting surface along the inside of the solid line indicated on the template.
- 4 Place the device in the cutout to test the fit.
- 5 If necessary, use a file and sandpaper to refine the size of the cutout.
- 6 After the device fits correctly in the cutout, ensure the mounting holes on the device line up with the pilot holes on the template.
- 7 If the mounting holes on the device do not line up, mark the new pilot-hole locations.
- 8 Using a 3.5 mm ($\frac{9}{64}$ in.) drill bit, drill the pilot holes.
- 9 Remove the template from the mounting surface.
- 10 If you will not have access to the back of the device after you mount it, connect all necessary cables to the device before placing it into the cutout.
- 11 If necessary, cover unused connectors with the attached weather caps to prevent corrosion of the metal contacts.
- 12 Remove the protective liner from the foam gasket.
- 13 Install the gasket ① on the back of the device.

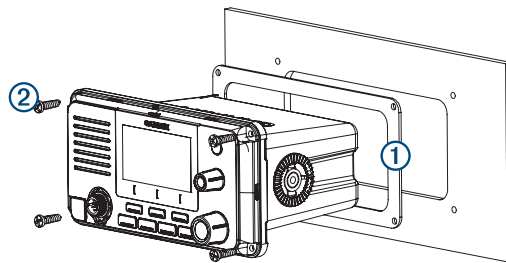

- 14 Place the device in the cutout.
- 15 Secure the device to the mounting surface using the included screws ②.
- 16 Install the decorative bezel by snapping it in place around the edges of the device.

Mounting the Microphone Hanger

NOTICE

If you are mounting the bracket on fiberglass with screws, it is recommended to use a countersink bit to drill a clearance counterbore through only the top gel-coat layer. This will help to avoid cracking in the gel-coat layer when the screws are tightened.

You can mount the microphone hanger in a convenient location near the radio.

- 1 Select a mounting location for the microphone within reach of the microphone cable.
- 2 Using the microphone hanger ① as a template, mark the pilot holes.

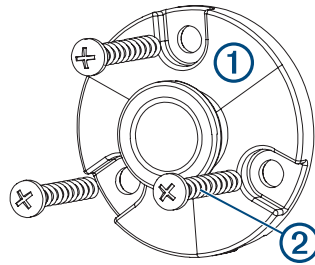

- 3 Drill the mounting holes using a 3 mm ($1/8$ in.) drill bit.
- 4 Secure the microphone hanger to the mounting surface using the included screws ②.

Connection Considerations

Connectors and port locations vary by model.

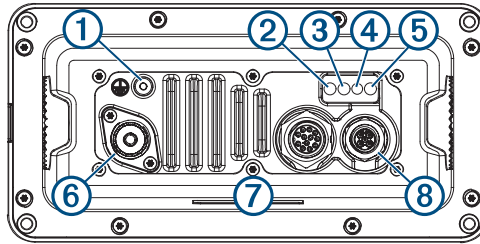

Item	Description	Notes
①	Ground connection	You can connect the device to water ground, if needed (Additional Grounding Considerations, page 5).
②	Red power wire with fuse	You must connect the device to a 12 Vdc power source (Connecting to Power, page 5).
③	Black power ground wire	
④	GPS cable with BNC connector	You can connect this device to an external GPS antenna (optional) (Connecting to a Remote GPS Antenna, page 8).
⑤	Data wiring harness ¹	You can connect this device to a NMEA 0183 device to share information (optional) (NMEA 0183 Device Connections, page 9). You can connect this device to a hailer horn (optional for VHF 215/VHF 215 AIS models) (Connecting to a Hailer Horn or PA Speaker, page 10). You can connect this device to an external speaker (optional) (Connecting to an External Speaker, page 10).
⑥	VHF antenna port	You must connect the device to a VHF antenna (sold separately) (Connecting a VHF Antenna, page 6).
⑦	Additional microphone port	You can add an additional microphone (sold separately) or relocate the existing microphone on a VHF 215/VHF 215 AIS radio (microphone relocation kit sold separately). Not available on VHF 115 radio models.
⑧	NMEA 2000® port	You can connect this device to a NMEA 2000 network to share information (optional) (NMEA 2000 Connections, page 7).

Connecting to Power

- 1 Route the power wiring cable to the power source and to the device.
- 2 Connect the red wire to the positive (+) battery terminal, and connect the black wire to the negative (-) battery terminal.

Additional Grounding Considerations

This device should not need any additional chassis grounding in most installation situations. If interference is experienced, the grounding screw on the housing can be used to connect the device to the water ground of the boat to help avoid the interference.

¹ Includes NMEA® 0183 wires (purple, gray, blue, and brown) and speaker wires (red and black). VHF 215/VHF 215 AIS models also include white and green hailer wires.

Connecting a VHF Antenna

- 1 Mount the VHF antenna (sold separately) according to the installation instructions provided with the antenna.
NOTE: You can purchase a VHF extension cable. Go to garmin.com or contact your Garmin dealer.
- 2 Connect the VHF antenna cable to the VHF antenna port on the VHF device.

NMEA 2000 Connections

NOTICE

If you are installing a NMEA 2000 power cable, you must connect it to the boat ignition switch or through another in-line switch. NMEA 2000 devices will drain your battery if the NMEA 2000 power cable is connected to the battery directly.

If you are unfamiliar with NMEA 2000, you should read the “NMEA 2000 Network Fundamentals” chapter of the *Technical Reference for NMEA 2000 Products*. Go to garmin.com/manuals/nmea_2000.

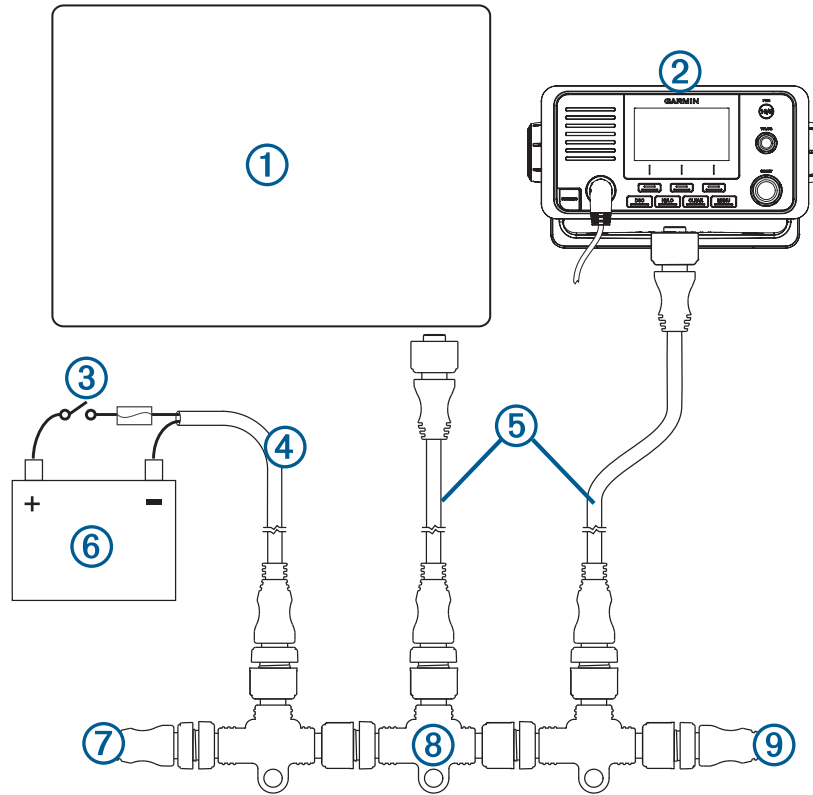

Item	Description
①	Compatible NMEA 2000 chartplotter or other device
②	VHF 115/VHF 215/VHF 215 AIS device
③	Ignition or in-line switch
④	NMEA 2000 power cable
⑤	NMEA 2000 drop cable
⑥	12 Vdc power source
⑦	NMEA 2000 terminator or backbone cable

Item	Description
⑧	NMEA 2000 T-connector
⑨	NMEA 2000 terminator or backbone cable

Connecting to a Remote GPS Antenna

This device includes an internal GPS antenna. If your mounting location does not provide good GPS reception, you may install a remote GPS antenna with a female BNC connector (not included), and connect it to the device.

NOTE: If you connected this device to a NMEA 2000 with a GPS antenna, you can use that antenna as a GPS source instead of installing a remote GPS antenna ([NMEA 2000 Connections, page 7](#)).

- 1 Follow the instructions provided with the external GPS antenna to install it on your boat correctly.
- 2 Route the GPS antenna cable to the back of the VHF 115/VHF 215/VHF 215 AIS device, away from sources of electrical interference.
- 3 Connect the GPS antenna cable to the BNC connector on the wiring harness on the VHF 115/VHF 215/VHF 215 AIS device.

NMEA 0183 Device Connections

This diagram illustrates two-way connections for both sending and receiving data. You can also use this diagram for one-way communication. The table below identifies the wiring harnesses and the NMEA 0183 wires.

To receive information from a NMEA 0183 device, refer to items ①, ②, ③, and ④ when connecting the Garmin device.

To transmit information to a NMEA 0183 device, refer to items ①, ②, ⑤, and ⑥ when connecting the Garmin device.

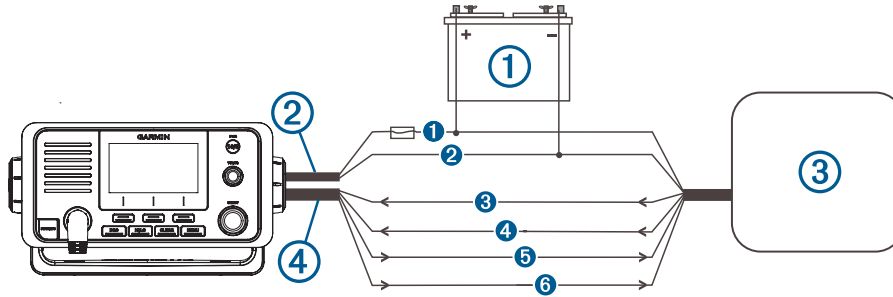

Item	Description
①	Power source
②	Power cable
③	NMEA 0183 device
④	NMEA 0183 cable

Item	Garmin Wire Function	Garmin Wire Color	NMEA 0183 Device Wire Function
①	Power	Red	Power
②	Power ground	Black	Power ground
③	Rx/A (In +)	Purple	Tx/A (Out +)
④	Rx/B (In -)	Gray	Tx/B (Out -)
⑤	Tx/A (Out +)	Blue	Rx/A (In +)
⑥	Tx/B (Out -)	Brown	Rx/B (In -)

If you are connecting to a hailer horn, see [Connecting to a Hailer Horn or PA Speaker, page 10](#).

If you are connecting to an external speaker, see [Connecting to an External Speaker, page 10](#)). Speaker wires are the red and black wires on the data harness ④. The red power wire ① and black power ground wire ② are on the separate power harness ②.

Connecting to an External Speaker

You can connect your VHF device to an external marine speaker (not included) to amplify sound at remote locations on the vessel or to communicate with other vessels.

- 1 If necessary, mount the external marine speaker according to the installation instructions provided with the speaker.
- 2 Route or extend the wire from the external speaker to the VHF device.
- 3 Connect the red wire on the data cable to the positive (+) wire from the external speaker.
NOTE: Make sure this is the red wire on the data cable. The power harness has a red wire that connects to the power source.
- 4 Connect the black wire on the data cable to the negative (-) wire from the external speaker.
NOTE: Make sure this is the black wire on the data cable. The power harness has a black wire that connects to the power ground.
- 5 Cover the connections with a waterproof tape or heat-shrink tubing.

Connecting to a Hailer Horn or PA Speaker

You can connect a VHF 215 radio to a hailer horn or public address (PA) speaker (not included) to use the microphone or the handset to make announcements.

NOTE: The VHF 115 models cannot be connected to a hailer horn.

Some VHF models include a foghorn feature as part of the public address system. You can sound the foghorn through a hailer horn or a PA speaker. To use the foghorn you must provide and install a hailer horn (optional) on the deck or tower of your boat.

- 1 If necessary, mount the hailer horn or PA speaker according to the installation instructions provided with the device.
NOTE: To avoid feedback, you should mount the hailer horn or PA speaker at least 3 m (10 ft) away from, and facing away from, the microphone or handset.
- 2 Route or extend the wire from the hailer horn or PA speaker to the radio.
- 3 Connect the white wire on the data cable to the positive (+) wire from the hailer horn or PA speaker.
- 4 Connect the green wire on the data cable to the negative (-) wire from the hailer horn or PA speaker.
- 5 Cover the connections with a waterproof tape or heat-shrink tubing.

Appendix

Specifications

Specification	Measurement
Dimensions (H x W x D)	VHF 115: 8.5 x 17 x 14.6 cm (3.35 x 6.7 x 5.75 in.) VHF 215/VHF 215 AIS: 9.8 x 19.7 x 14.9 cm (3.86 x 7.76 x 5.78 in.)
Weight	VHF 115 (with microphone): 1.241 kg (43.77 oz.) VHF 215/VHF 215 AIS (without microphone): 1.212 kg (42.75 oz.) VHF 215/VHF 215 AIS microphone: 0.248 kg (8.75 oz.)
Operating temperature range	From -15° to 55°C (from 5° to 131°F)
Storage temperature range	From -20° to 70°C (from -4° to 158°F)
Compass-safe distance	VHF 115: 70 cm (27.6 in.) VHF 215/VHF 215 AIS: 75 cm (29.5 in.)
Water rating	IEC 60529 IPX7 ¹
Antenna connector	S0-239 (50 ohms)
Operating voltage	12.0 Vdc
Wireless frequency	156 to 162 MHz @ 44 dBm (25 W) maximum
Standby current draw	350 mA
Receive current draw	600 mA
Transmit current draw	From 2.0 A to 6.0 A (from 1 W to 25 W)
Maximum antenna gain	9 dBi
Antenna port impedance	50 ohms
Internal speaker audio output power	1 W (with 4 ohms at 10% distortion)
External speaker audio output power	4 W (4 ohms/max)
External speaker impedance	4 ohms
Hailer output power	20 W at 4 ohms
Hailer horn impedance	4 ohms
NMEA 2000 LEN @ 9.0 Vdc	1 (50 mA)

¹ The device withstands incidental exposure to water of up to 1 m for up to 30 min. For more information, go to www.garmin.com/waterrating.

NMEA 2000 PGN Information

Transmit

PGN	Description
059392	ISO acknowledgment
060928	ISO address claim
061184	Single-frame proprietary
126208	NMEA request group function
126464	PGN's group function
126720	Fast-packet proprietary
126993	Heartbeat
126996	Product information
126998	Configuration information
129799	Radio frequency/mode/power
129808	DSC call information

Receive

PGN	Description
059392	ISO acknowledgment
059904	ISO request
060160	ISO transport protocol, data transfer
060416	ISO transport protocol, connection management - RTS group function
060928	ISO address claim
061184	Single-frame proprietary
065240	ISO commanded address
126208	NMEA request group function
126720	Fast-packet proprietary
129026	COG and SOG, rapid update
129029	GNSS position data
129044	Datum

Transmit (AIS models only)

PGN	Description
129038	AIS class A position report
129039	AIS class B position report
129040	AIS class B extended position report

PGN	Description
129041	AIS Aids to Navigation (AtoN) report
129794	AIS class A static and voyage related data
129798	AIS SAR aircraft position report
129802	AIS safety related broadcast message
129809	AIS class B "CS" static data, part A
129810	AIS class B "CS" static data, part B

NMEA 0183 Information

Transmit

Sentence	Description
DSC	Digital selective calling (DSC) information
DSE	Expanded digital selective calling
VDM (AIS model only)	AIS VHF data-link message

Receive

Sentence	Description
DTM	Datum reference
GGA	Global positioning system fix data
GLL	Geographic position (latitude and longitude)
GNS	GNSS fix data
RMA	Recommended minimum specific Loran-C data
RMC	Recommended minimum specific GNSS data

© 2018 Garmin Ltd. or its subsidiaries

Garmin® and the Garmin logo are trademarks of Garmin Ltd. or its subsidiaries, registered in the USA and other countries. GHS™ is a trademark of Garmin Ltd. or its subsidiaries. These trademarks may not be used without the express permission of Garmin.

NMEA® and NMEA 2000® are registered trademarks of the National Marine Electronics Association. Other trademarks and trade names are those of their respective owners.

