

# How to install your ecobee Switch+





## Warning

Installing this product involves handling **high voltage wiring**. Each step of the enclosed instructions must be followed carefully.

To avoid fire, personal injury, or death, **turn off your circuit breakers and follow the proper safety precautions before proceeding.**

**UNSURE ABOUT HANDLING  
ELECTRICAL WIRING?  
CONSULT A QUALIFIED ELECTRICIAN.**

## Getting your Switch+ up and running is as easy as 1-2-3

1. Download the ecobee app.
2. Install your Switch+.
3. Register ecobee Switch+ to unlock Amazon Alexa and other smart features.

### Daylight helps

You'll need to turn off your power for installation. We recommend getting started during the day.

## Step-by-step visual guides that land you right at registration

Download the ecobee app—where you'll find videos, diagrams, and a guided tour of registration and smart features.



## What's in the box:

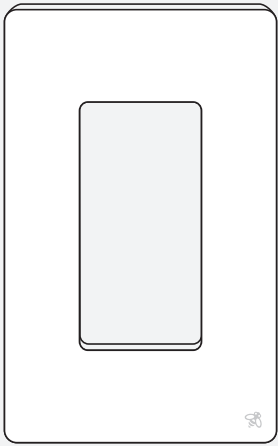

Wall plate

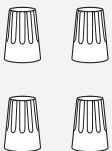

4 wire nuts

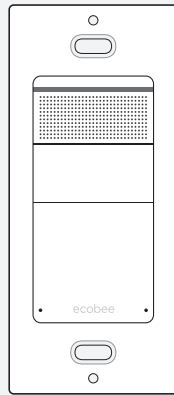

ecobee  
Switch+



2 mounting  
screws

## Tools you'll need:

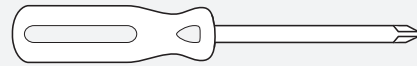

Phillips  
head #2  
screwdriver

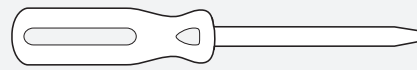

Flat head  
screwdriver

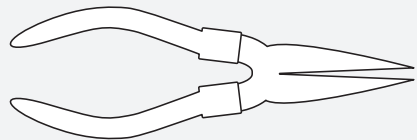

Pliers  
(optional)

# 1

## Compatibility and rating

Is this location controlled by only one switch?

ecobee Switch+ can only be installed in locations where the light is controlled by only one switch.

Do you have at least one neutral wire in your set-up?

Neutral wires are white and come as either a single wire or a pair. Unsure? Keep reading for instructions.

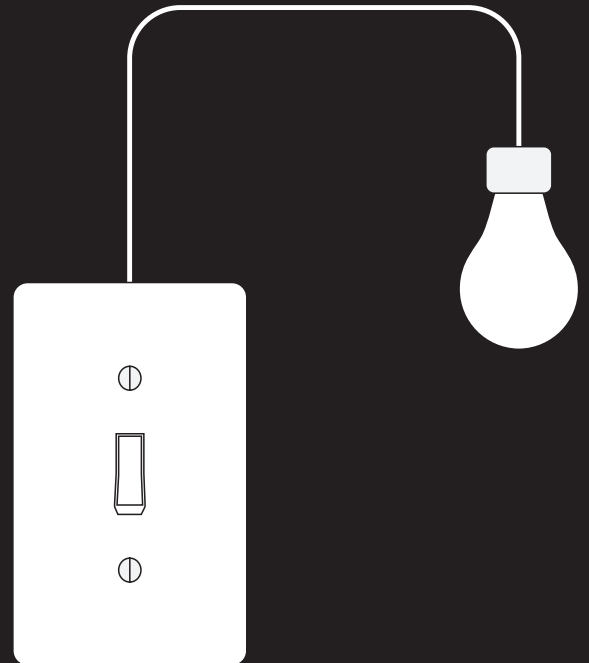

### Rating

120V AC 60Hz

600W Incandescent

150W I.BAL (LED and CFL)

# 2

## Turn off your breakers

Turn off the circuit breaker for the switch you're replacing.

If breakers aren't labeled, turn off the master power.

### Before proceeding

Your lights should **NOT** turn on. Confirm you've turned off the right breaker by flipping your wall switch on and off several times.

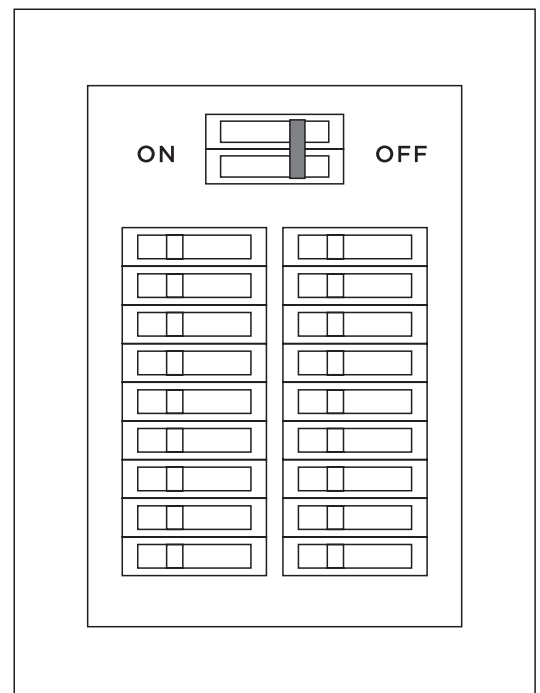

# 3

## Remove old switch

Unscrew your existing wall plate and switch from the wall.

Disconnect the wires attached to your switch by turning the wire nuts counterclockwise. Remove your existing switch.



If paint has dried around your switch, it may require more force to unmount it.

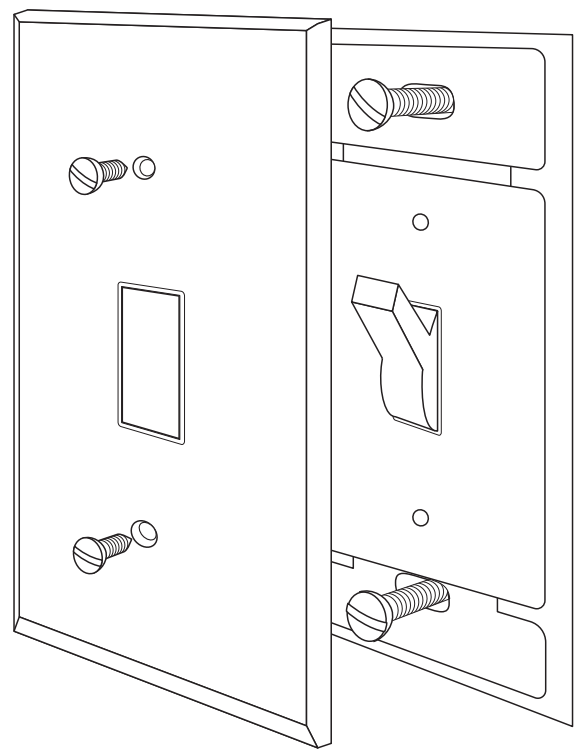

# 4

## Identify wires

You should see 4 types of wires in your wall box. Here's how to identify them.

**Ground wire (exposed copper or green)**  
typically comes from the wall box.

**Line and load wires (black or red)**  
are connected to your existing switch.

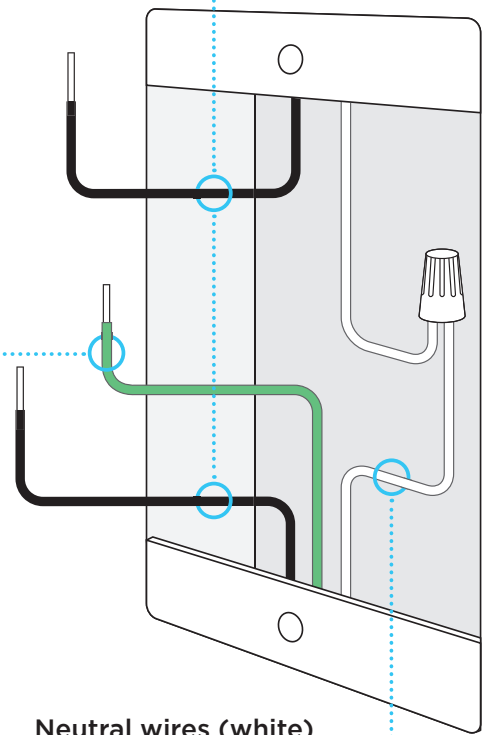

**Neutral wires (white)**  
typically come in a pair and are fastened together by a wire nut.  
**Needed for installation.**



# 5

## Connect your Switch+

Match the neutral wire from your Switch+ to the 2 neutral wires from your wall box. Together, insert them into the wire nut to connect. Match the remaining wires as shown and secure with wire nuts.

- Switch wire → Line wire
- Switch wire → Load wire
- Neutral wire → Neutral pair
- Ground wire → Ground wire or screw

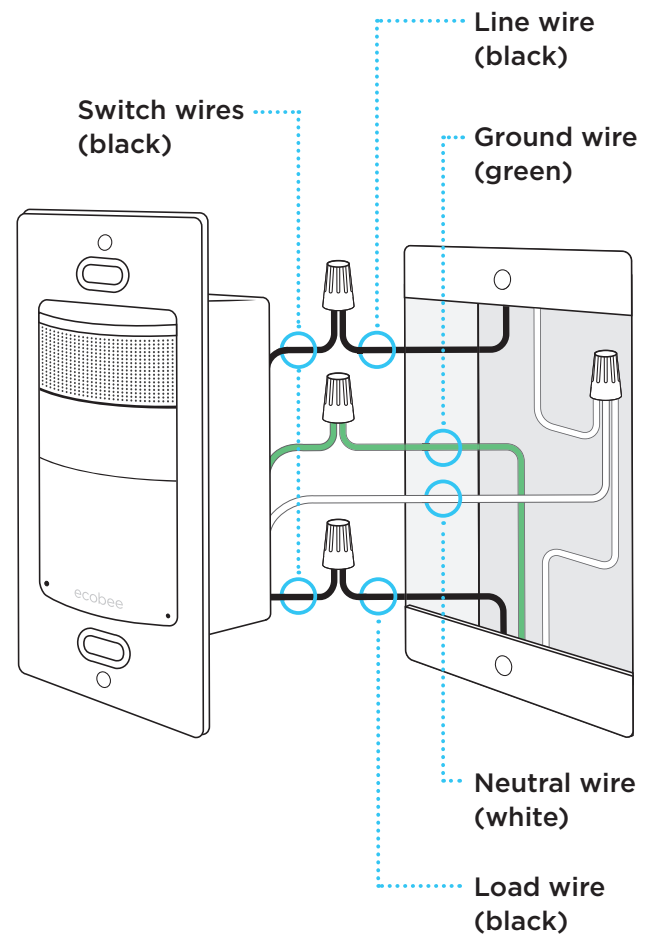

Don't know how to use a wire nut?  
Turn the page for help.

## Wire nuts 101

Wire nuts are used to connect two or more wires together.

### Connecting wires

Hold the wires you're connecting parallel to one another so that the ends are aligned.

Holding the wires together and parallel, insert them into a wire nut. Twist the wire nut clockwise until secure. Double-check by tugging on the wires gently.

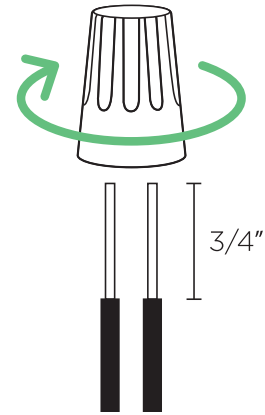

If they separate or shift inside the nut, realign the wires and replace the cap. Twist the cap clockwise until the wires are secured.



If you have pliers, use them to gently twist wires together before inserting them into the wire nut. You can also use them to straighten curved wires.

# 6

## Fit wire nuts into wall box

Push each wire nut in—one at a time—as close to the back of the wall box as possible.

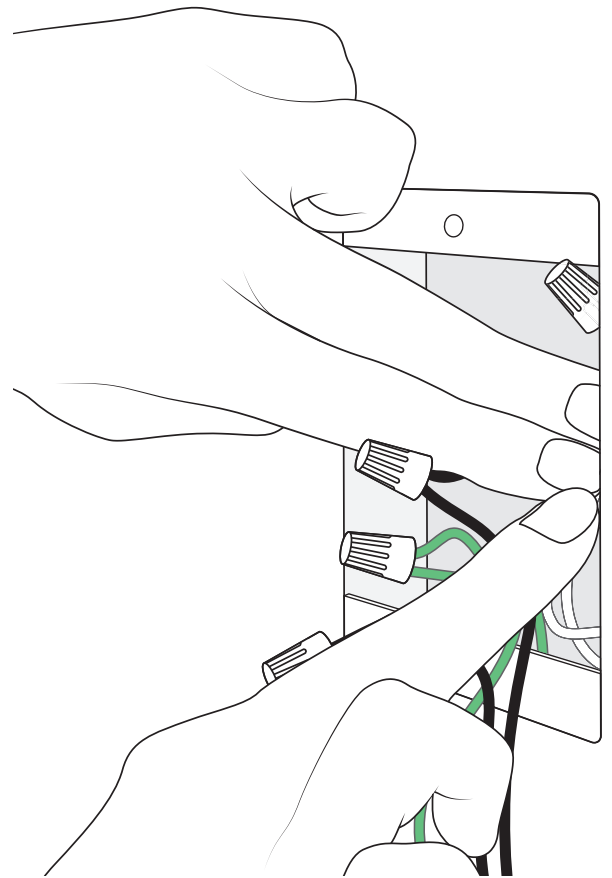

# 7

## Mount ecobee Switch+

Using the mounting screws provided, mount your ecobee Switch+. Make sure it's level and flush against the wall.

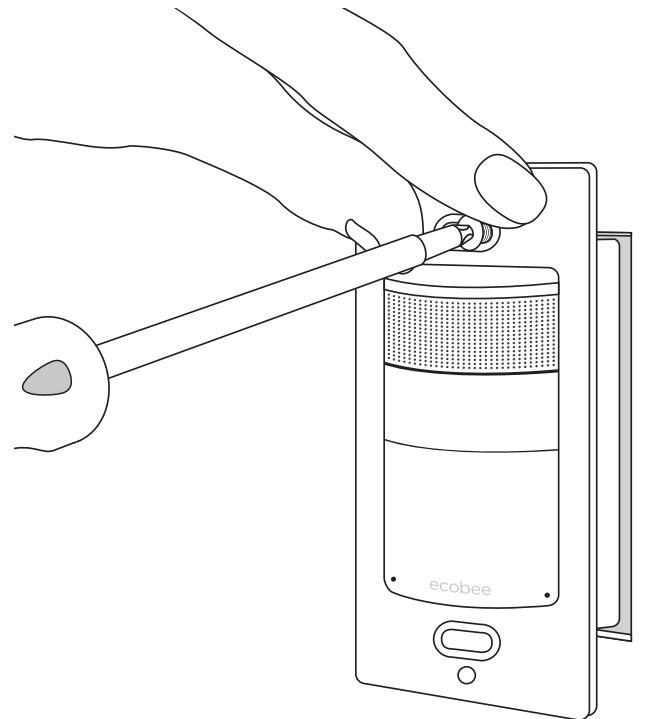

# 8

## Power system back on

Return to your circuit breaker and turn on the power for the switch you just replaced.

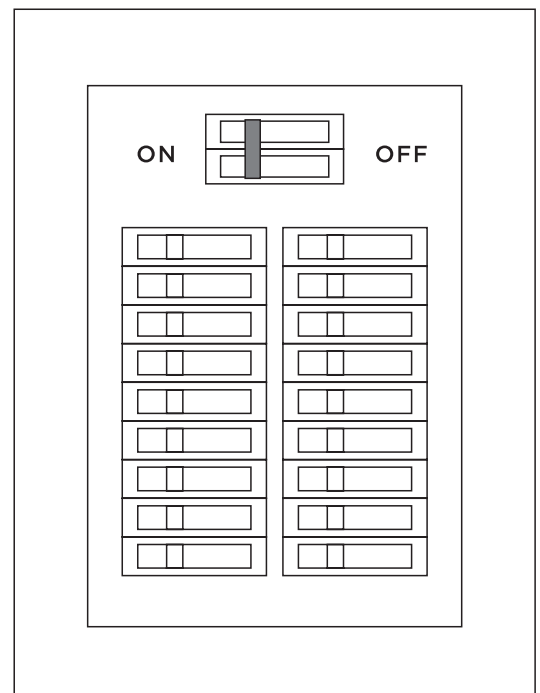

# 9

## Test your Switch+

Give your Switch+ a moment to power on. Test it by turning it on and off, using the on/off button on the front of your Switch+. If it powers on, snap on your wall plate.

If your Switch+ does not power on, turn off your circuit breaker and double check that your wires are connected securely. Then test again.

Still a no-go? Call ecobee customer support at 1-877-932-6233.

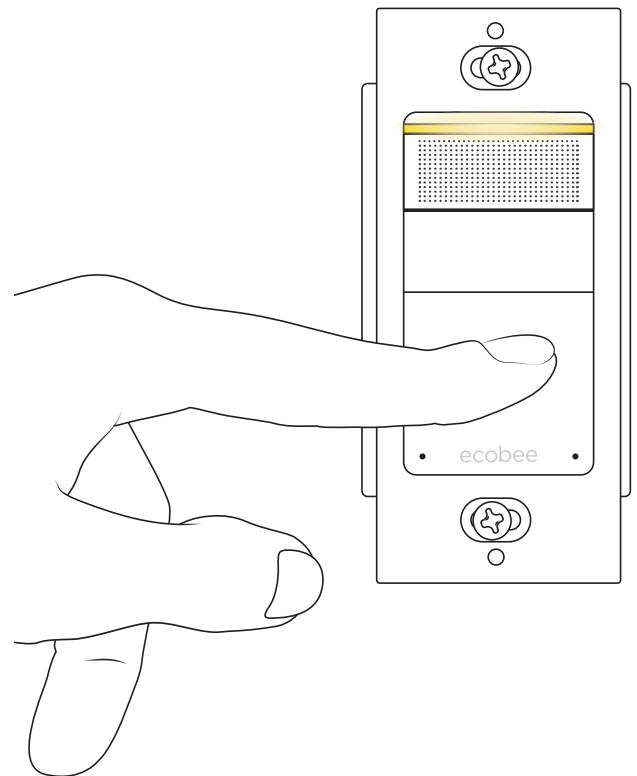

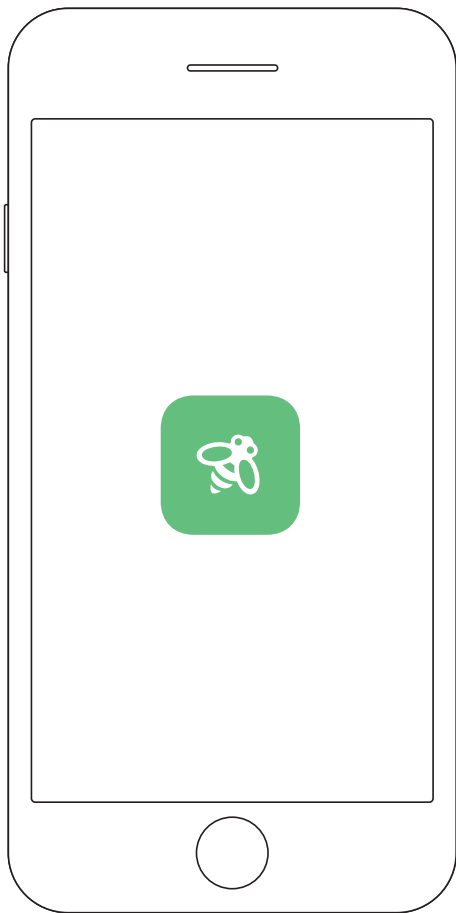

## Congratulations, you did it!

Keep going on the ecobee app to register your device, connect to Wi-Fi, and unlock smart features.

To connect to HomeKit, use the ecobee app on your iOS device and refer to the code on the back of this manual.

# Your ecobee Switch+

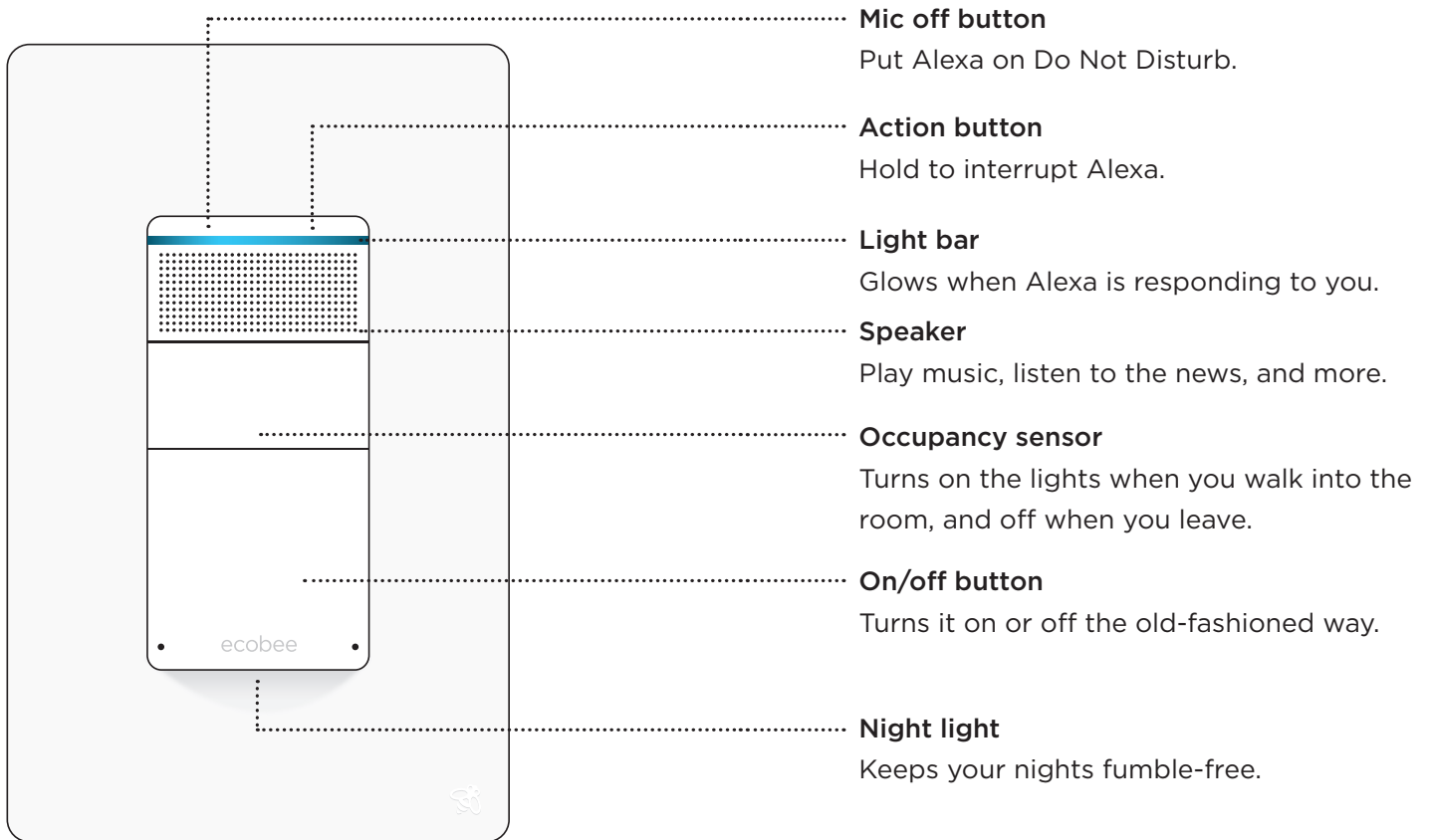



# Here's what your Switch+ can do



## Ask Alexa\*

Ask to turn the lights on or off, set a timer, read the news or weather, play music or podcasts, and more.



## Turns off your lights for you

We'll take care of it when the room is empty.



## Go hands-free

Have your lights turn on when you enter the room and it's dark.



## Smarter outdoor lighting

Upgrade your lighting to automatically turn on at sunset and off when you choose.



## Night light

Enable the night light setting on your ecobee app to make your Switch+ glow in the dark.

# Troubleshooting

Press and hold the on/off button on the front of your Switch+ for 5 seconds.

Using voice prompts\*, your Switch+ will cycle through the options: reset Wi-Fi, reset HomeKit, restart device, and reset device to factory settings.

Select an option by pressing the on/off button again, or cancel the menu by pressing either of the top buttons.

\*Not all languages may be available on Amazon Alexa Voice Service. Go to Amazon.com for the list of currently supported languages.

## We're here to help

[ecobee.com](http://ecobee.com)

[support@ecobee.com](mailto:support@ecobee.com)

1-877-932-6233

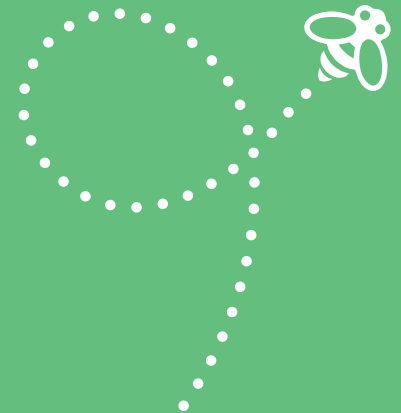

## Approvals

This product was designed and built in accordance to RoHS directive 2002/95/EC and contains no hazardous substances as defined by this directive.

### FCC Compliance Statement Compliance Notice:

This equipment has been tested and found to comply with the limits for a Class B digital device, pursuant to part 15 of the FCC Rules. These limits are designed to provide reasonable protection against harmful interference in a residential installation. This equipment generates, uses and can radiate radio frequency energy and, if not installed and used in accordance with the instructions, may cause harmful interference to radio communications. However, there is no guarantee that interference will not occur in a particular installation. If this equipment does cause harmful interference to radio or television reception, which can be determined by turning the equipment off and on, the user is encouraged to try to correct the interference by one or more of the following measures:

- Reorient or relocate the receiving antenna.
- Increase the separation between the equipment and receiver.
- Connect the equipment into an outlet on a circuit different from that to which the receiver is connected.
- Consult the dealer or an experienced radio/TV technician for help.

This device complies with part 15 of FCC rules. Operation is subject to the following two conditions:

1. This device may not cause harmful interference.
2. This device must accept any interference received, including interference that may cause undesired operation.

Changes or modifications that are not expressly approved by the manufacturer could void the user's authority to operate the equipment.

### RF Exposure Information:

This equipment complies with FCC radiation exposure limits set forth for an uncontrolled environment. In order to avoid the possibility of exceeding the FCC radio frequency exposure limits, human proximity to the antenna shall not be less than 8 inches during normal operation.

### Industry Canada (IC) Compliance Notice:

This device complies with Industry Canada license-exempt RSS standard(s).

Operation is subject to the following two conditions:

1. This device may not cause interference.
2. This device must accept any interference, including interference that may cause undesired operation of the device.

This Class B digital apparatus complies with Canadian ICES-003.

**RF Exposure Statement:**

This equipment complies with IC RSS-102 radiation exposure limits set forth for an uncontrolled environment. This transmitter must be installed to provide a separation distance of at least 8 inches from all persons and must not be collocated or operating in conjunction with any other antenna or transmitter.

FCC ID: WR9EBSMSW1V001  
IC ID: 7981A-EBSMSW1V001  
CAN ICES-3 (B)/NMB-3(B)  
Designed in Canada. Assembled in China.

Warning: Changes or modifications not expressly approved by ecobee Inc. could void the user's authority to operate the equipment.

**1-Year Limited Warranty**

ecobee warrants that for a period of one (1) year from the date of purchase by the consumer ("Customer"), the Switch+ (the "Product") shall be free of defects in materials and workmanship under normal use and service. During the warranty period, ecobee shall, at its option, repair or replace any defective Products, at no charge. Any replacement and/or repaired device are warranted for the remainder of the original warranty or ninety (90) days, whichever is longer. A proof-of-purchase will be required from the Customer in order for ecobee to provide a replacement and/or repaired device. This Warranty is valid only for Product installed in the country in which it is purchased.

If the product is defective, call Customer Service at 1-877-932-6233. ecobee will make the determination whether a replacement product can be sent to you or whether the product should be returned to our address.

In the event of a failure of a Product, Customer may:

- a. if Customer did not purchase the Product directly from ecobee, contact the third party contractor from whom the Product was purchased to obtain an equivalent replacement product, provided the contractor determines that the returned Product is defective and Customer is otherwise eligible to receive a replacement product;
- b. contact ecobee directly for service assistance at 1-877-932-6233 and ecobee will make the determination whether an advance equivalent replacement Product can be sent to Customer with return shipping supplies (in which case a hold shall be put on Customer's credit card for the value of the replacement Product until ecobee has received the defective Product). Product should be returned to our address. If the returned Product is found by ecobee to be defective and Customer is otherwise eligible to receive a replacement product, no amount shall be charged to Customer's credit card; or
- c. ship the defective Product directly to ecobee, in which case Customer shall contact ecobee directly at 1-877-932-6233, so ecobee can make the required shipping arrangements. Upon receipt of the defective Product, ecobee will ship an equivalent replacement product to Customer, provided the returned Product is found by ecobee to be defective and Customer is otherwise eligible to receive a replacement product.

This warranty does not cover removal or reinstallation costs and shall not apply if the damages were found to be caused by something other than defects in materials or workmanship, including without limitation, if the Product:

- was operated/stored in abnormal use or maintenance conditions;
- is repaired, modified or altered, unless ecobee expressly authorizes such repair, modification or alteration in writing;
- was subject to abuse, neglect, electrical fault, improper handling, accident or acts of nature;
- was installed improperly.

ecobee's sole responsibility shall be to repair or replace the Product within the terms stated above. ECOBEE SHALL NOT BE LIABLE FOR ANY LOSS OR DAMAGE OF ANY KIND, INCLUDING ANY SPECIAL, INCIDENTAL OR CONSEQUENTIAL DAMAGES RESULTING, DIRECTLY OR INDIRECTLY, FROM ANY BREACH OF ANY WARRANTY, EXPRESS OR IMPLIED, OR ANY OTHER FAILURE OF THIS PRODUCT. Some US states and Canadian provinces do not allow the exclusion or limitation of incidental or consequential damages, so the above limitation or exclusion may not apply to you.

ecobee's responsibility for malfunctions and defects in materials and workmanship is limited to repair and replacement as set forth in this warranty statement. All express and implied warranties for the product, including but not limited to any implied warranties and conditions of merchantability and fitness for

a particular purpose, are limited to the one-year duration of this limited warranty. No warranties, whether expressed or implied, will apply after the limited warranty period has expired. Some US states and Canadian provinces do not allow limitations on how long an implied warranty lasts, so this limitation may not apply.

ecobee neither assumes responsibility for nor authorizes any other person purporting to act on its behalf to modify or to change this warranty, nor to assume for it any other warranty or liability concerning this product.

This warranty gives you specific rights, and you may also have other rights which vary from jurisdiction to jurisdiction. If you have any questions regarding this warranty, please write to ecobee Customer Service.

#### **Legal Notice**

Use of the HomeKit™ logo means that an electronic accessory has been designed to connect specifically to iPod®, iPhone®, or iPad®, respectively, and has been certified by the developer to meet Apple® performance standards. Apple is not responsible for the operation of this device or its compliance with safety and regulatory standards. Please note that the use of this accessory with iPod, iPhone, or iPad may affect wireless performance. Apple, iPhone, iPad, and iPod touch are trademarks of Apple Inc., registered in the U.S. and other countries. HomeKit is a trademark of Apple Inc.

# HomeKit set-up code:



770-00051

© 2017 ecobee, Inc. All rights reserved. ecobee and the ecobee logo are trademarks of ecobee Inc., registered in the U.S. and other countries.

Alexa is a trademark of Amazon Inc.