

Innovating the Art of Listening



# Jade II

Electrostatic Headphone System

User Guide

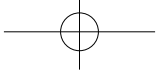

# HIFIMAN Jade II

Safety Cautions



TO REDUCE THE RISK OF ELECTRIC SHOCK, DO NOT REMOVE COVER (OR BACK). NO USER-SERVICEABLE PARTS INSIDE. REFER SERVICING TO QUALIFIED SERVICE PERSONNEL.

Warning: Non-insulated dangerous voltage within the product's enclosure may be of sufficient magnitude to constitute a risk of electric shock.



Important operating and maintenance instructions in this user guide.

Warning: To avoid fire or shock hazard, this product should not be exposed to rain or other moisture.

## **Note:**

To completely cut off the power, the electrical plug should be unplugged.

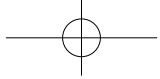

# HIFIMAN Jade II

Safety Cautions

## Warning:

### Amplifier

- Please read instructions carefully. Store and retain the operations guide for future reference. Pay attention to all warning information and operate in accordance with the instructions.
- Avoid high ambient temperature use. Do not operate the amplifier in a room temperature over 40°C or 104°F. Please allow the heat to fully dissipate after use.
- Grasp the plug firmly when the power cable is being unplugged. Do not pull the cable to unplug.
- This product should not be placed in a dusty, dirty environment or be exposed to very high humidity (sauna, bathroom etc.)
- The plug should be unplugged if the product will not be used for a long time.
- Air ventilation should not be blocked or obstructed.
- Nothing should be dropped into the amplifier. This could cause damage.
- Do not expose the product to chemicals such as pesticides, benzene, acids or alkaline.
- This product should not be disassembled or refitted by anyone other than HIFIMAN.
- To avoid fire, while the amplifier is working, air vents should not be obstructed with papers, tablecloth, curtains or any other items.
- Open flames such as candles should not be placed on or near the amplifier.
- Highly flammable, liquids should not be dropped or sprayed on the amplifier.
- To avoid fire hazard, items containing liquids such as vases or glasses should not be placed on the amplifier.
- Do not operate with wet or oily hands.
- There is high output on the output terminal of front panel of the amplifier. To avoid shock hazard, nothing should be inserted in the output port of the amplifier except a suitable headphone jack.
- The power cable should not be trampled on or be a trip hazard.
- Accessories and spare parts used should be specified by HIFIMAN only.
- In case of electrical storms please remove the plug from the power socket.

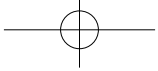

# HIFIMAN Jade II

Safety Cautions

## Headphone

- To avoid risk of electric shock and to protect the diaphragm from being damaged, nothing should be inserted into the grill on the headphone.
- As with the amplifier, the headphone should be kept away from a high temperature environment ( ambient temperature should not exceed 40°C or 104°F. )
- Keep the headphone away from substances such as alcohol, gasoline, acetone, other solvents, sulfuric acid, sodium hydroxide or any other corrosive substances.
- Do not treat the headphone violently as this may cause permanent damage to the internal structure and invalidate the warranty.
- If the headphone should get wet, do not use a heat gun or hairdryer on the product as this could permanently damage the headphone's diaphragm. Allow to dry naturally in a warm but dry environment such as an airing cupboard.
- Do not use the headphone with wet hair.
- If the product is to be left unused for a long time, please keep in the storage box and seal with a moisture-proofing agent to prevent mould or corrosion.

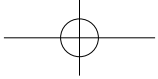

# HIFIMAN Jade II

Table of Contents

Thank you for your purchase of the Jade II Electrostatic Headphone System.  
To ensure the correct operation, please read the operating instructions carefully.  
After reading, please retain for reference in the future.

|                            |    |
|----------------------------|----|
| Technical Data .....       | 5  |
| Features .....             | 6  |
| Notes for Operation .....  | 8  |
| Functions .....            | 9  |
| Initial Setup .....        | 11 |
| Basic Connection .....     | 12 |
| Basic Operation .....      | 15 |
| Limited Warranty and ..... | 16 |
| Customer Service           |    |

\* Please be advised that illustrations may be different from the real system for the purpose of explanation.

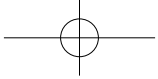

# HIFIMAN Jade II

Technical Data

## Specifications

Headphone

Frequency Response: 7Hz -90kHz

Bias Voltage: 550V-650V

Weight: 365g (12.9oz)

Amplifier

Weight: 6.5kg (14.3lb)

Dimensions: 276 x 270 x 116mm<sup>3</sup> (10.9" x 10.6" x 4.6")

## Accessories

| No. | Items                   | Quantity |
|-----|-------------------------|----------|
| 1   | Power Cable             | 1pc      |
| 2   | Electrostatic Headphone | 1pc      |
| 3   | Electrostatic Amplifier | 1pc      |
| 4   | Warranty Card           | 1pc      |
| 5   | User Guide              | 1pc      |

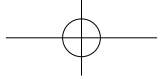

# HIFIMAN Jade II

Features

## Jade II Electrostatic Headphone

- Nano-particle coated diaphragm providing an extreme high frequency response and an excellent musical reproduction ability.
- The highly resolving audio and extremely high frequency range allows the sound-stage to be dramatically open and expansive compared to a traditional "moving coil" type headphone.
- A single crystal copper wire with gold-plated plug for lossless signal transmission.
- Nanometer thick dust cover helps prevent dust and other pollutants settling and avoiding ensuing distortion caused by electrostatic dust.
- Housing from ABS and a steel frame composed of a stainless-steel honeycomb mesh for the anode casing. The Honeycomb mesh can protect the headphone from airflow vibrations assuring that the sound reduction remains true and accurate.

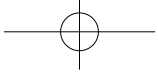

# HIFIMAN Jade II

Features

## Jade II Electrostatic Amplifier

- Operational amplifier and a hybrid discrete component design.
- TI Texas high precision dual op amp OPA2107AP for signal pre-amplification.
- Discrete transistor Cascode MOSFET, powering the balanced output amplification.
- High voltage power supply using an independent power supply regulator.
- PCB layout optimization, to reduce interference hum and allow for a more transparent sound.
- Made of aviation grade aluminum alloy, the advanced industrial design is from the HIFIMAN US design team in Boston.
- XLR balanced audio input and RCA source input ports.
- Equipped with two headphone output ports.
- A 21 level volume control to allow for precision volume control.
- AC 115V / 230V power selector.



## Warning:

Please read the following instructions before connecting this product to a power source for the first time. Power voltage might vary in different countries and areas.

Please make sure the rated voltage ( for instance, alternating current AC 230V 50Hz or alternating current AC 115V 60Hz ) on the panel corresponds to local mains voltage. If not, the power supply should be turned off and the power cable should be disconnected, adjust the voltage selector with a flat head screwdriver. Make sure the power supply corresponds to the local mains voltage before reconnecting.

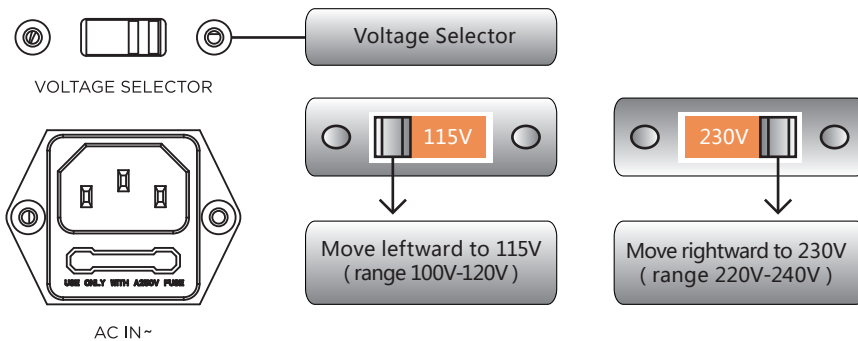

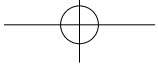

# HIFIMAN Jade II Functions

## Front Panel

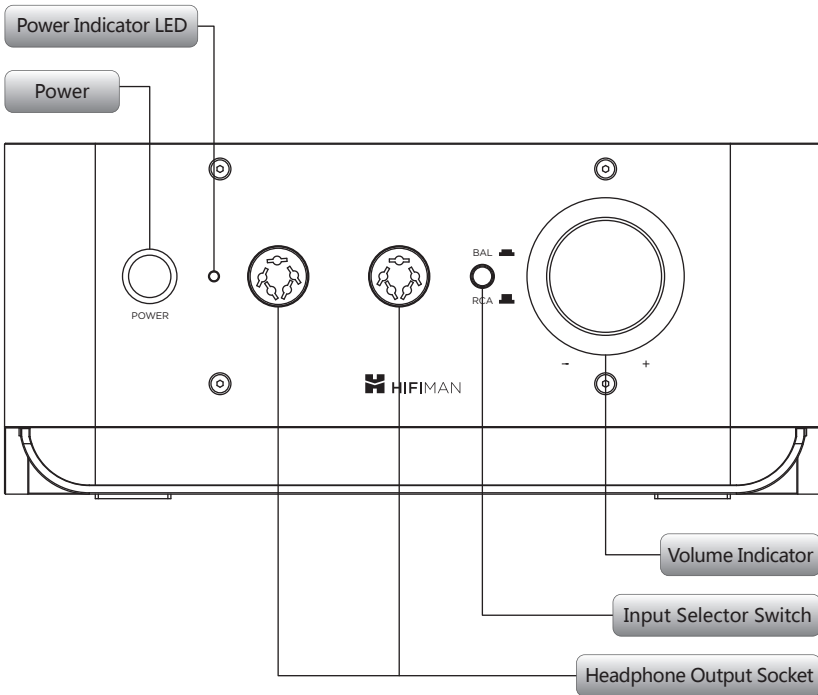

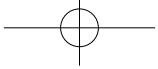

# HIFIMAN Jade II Functions

## Rear Panel

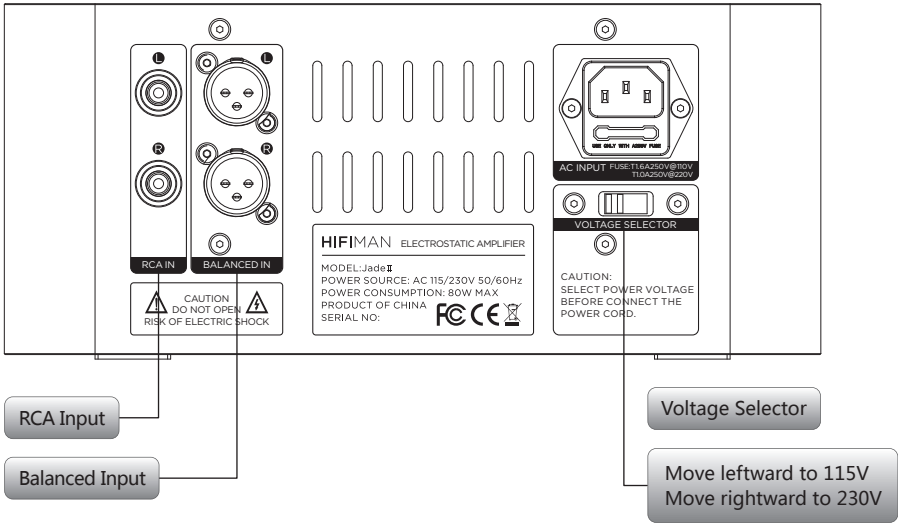

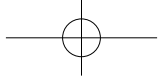

# HIFIMAN Jade II

Initial Setup

## Preparatory Work

- Open the package box, remove the amplifier and power cable carefully.
- Put the device on a stable surface, then remove the protective film from the top panel.



## Connection to Audio Input Source and Power Source

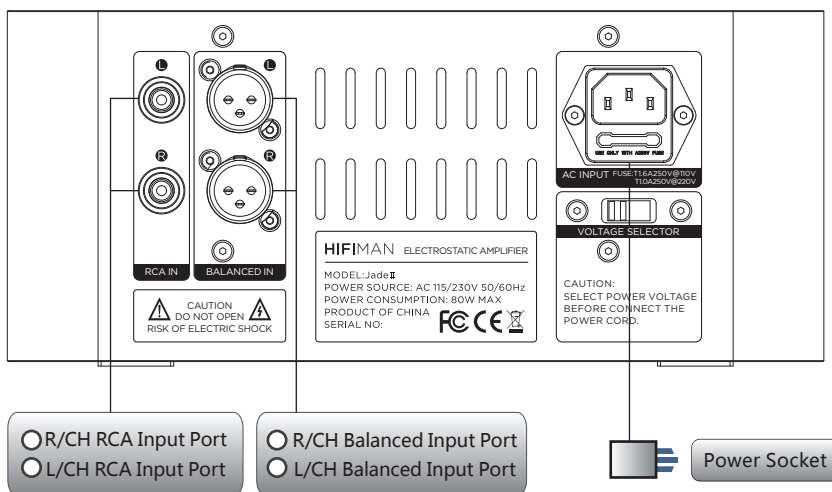

\* Make sure the power supply switch corresponds to local mains voltage before connecting to power socket.

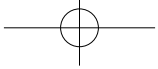

# HIFIMAN Jade II

Basic Connection

**Two pairs of electrostatic headphones can be connected to the amplifier and operated at the same time.**

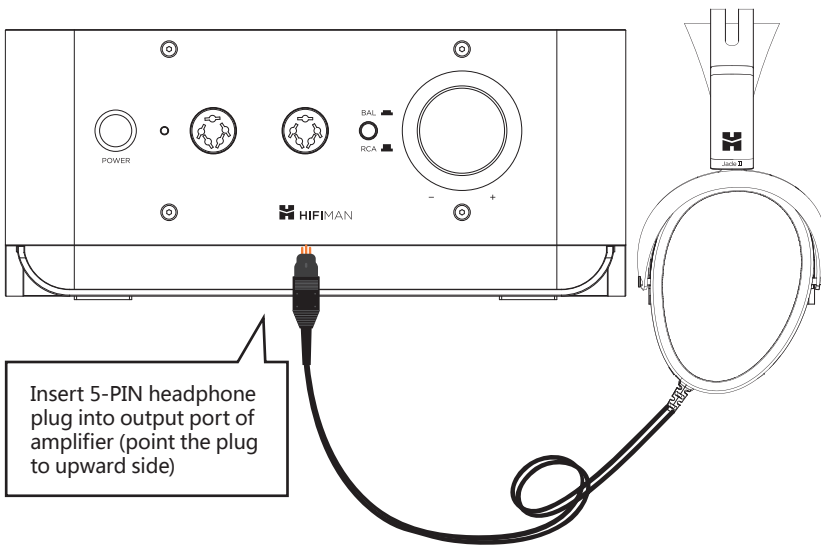

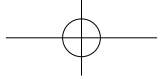

# HIFIMAN Jade II

Basic Connection

## Initial Use

When the "POWER" switch on the front panel is pushed on, the red LED on the front panel blinks for 30 seconds. When the LED lights up continuously, the unit is ready to operate.

Plug the headphone into one of the sockets on the front panel.

Select the connected input signal using the "INPUT" selector switch beside the input connector.

Turn the volume potentiometer clockwise to set optimal volume level. Output sound level can be read from indicators around the knob.

## Balanced Input and AUX Input

Press the switch to select the Balanced Input source.

Press the switch again (the switch will reset) to select the RCA Input source.

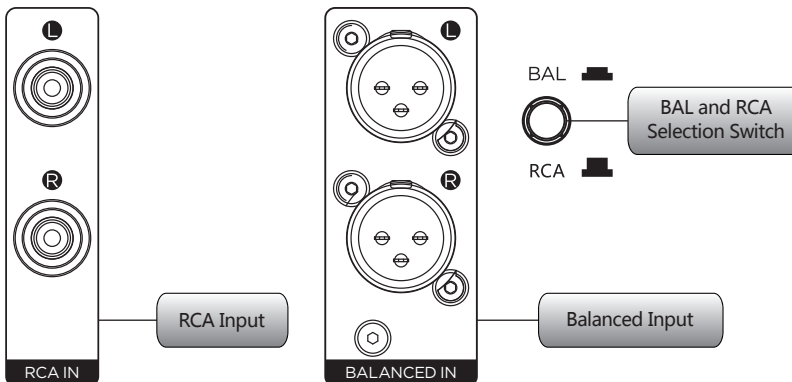

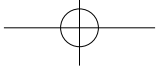

## Please check the following possible issues:

Are the connections correct?

Has the device been operated in accordance with the manual?

Are the connecting devices working properly?

If the product is not operating properly, please check for the following problems.

If you require assistance please contact the distributor from whom this product has been purchased or contact HIFIMAN customer service.

| Problems                                    | Possible Causes   | Solutions   | page |
|---|---|---|------|
| Power indicator will not come on            | Power plug not inserted properly or fully                       | Check the power plug has been inserted into the socket properly and fully | 12   |
| Power indicator is on but there is no sound | Input cable not properly or fully inserted                      | Correct the input cable connection  | 12   |
|   | Headphone cable not properly or fully inserted                  | Correct the headphone cable connection                                    | 13   |
|   | Incorrect input selection                                       | Set the input selector switch correctly                                   | 10   |
|   | The volume is set very low                                      | Slowly increase the volume output with the volume dial                    | 14   |
| Left and right channel are reversed         | The left and right input cables are reversed                    | Correct the left and right channel connection                             | 12   |
| No sound from one channel                   | The left or right input cable is not properly or fully inserted | Correct the left and right channel connection                             | 12   |



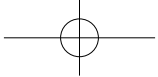

# HIFIMAN Jade II

Limited Warranty and  
Customer Service

HIFIMAN provides one year warranty on the Jade II Electrostatic Headphone System.

For further support and service if needed,

please contact HIFIMAN at [customerservice@hifiman.com](mailto:customerservice@hifiman.com)



Innovating the Art of Listening

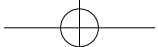



## FACEBOOK

Scan QR Code to join  
HIFIMAN on facebook



Customer Service Tel: +1 201-443-4626  
E-mail: [customerservice@HIFIMAN.com](mailto:customerservice@HIFIMAN.com)  
Website: [www.hifiman.com](http://www.hifiman.com)

 [hifimanelectronics](https://www.facebook.com/hifimanelectronics)  [store.hifiman.com](http://store.hifiman.com)  [twitter.com/hifimanofficial](https://twitter.com/hifimanofficial)