

INTRODUCTION

The LiftMaster® Passport™ PPLX reader is a programmable single-door access control system, which controls access for up to 50,000 users. It can control a gate operator, electric strike, magnetic lock, or commercial door operator. The reader contains the CPU, memory, access relay, and an internal reader. A Wiegand output is also provided to allow for later upgrading to an online system. The reader also has an additional programmable input, which may be set as a remote open input or as an LED control for use with the Wiegand output. It also has a beeper, and a bi-color LED indicator. The reader is capable of reading multiple Wiegand Card protocols. As a stand-alone access device, the reader has the ability to read 34 bit Passport™, 30 bit Sentex®, and 26 bit industry standard card protocols. The PPRP Handheld Programmer (not provided) is required to program the reader.

SPECIFICATIONS

POWER REQUIREMENTS

5-14 Vdc, 50 mA idle, 150 mA Max.

OUTPUTS

SPST Solid State Relay, 1A max. @60 Vac or dc
Normally open or normally closed (field programmable) (refer to Programming section).

INPUTS

Default is Remote Open (requires contact closure).
Also programmable as Bi-color (Red or Green) LED Control or Buzzer/LED control for online systems (refer to Programming section).

WIEGAND OUTPUT

Any Wiegand Format up to 40 bits
Maximum Distance: 500 ft. - 5 or 8 conductor 20 gauge shielded cable

ENVIRONMENT

Reader, Key Tags, and Cards:
Ambient Temperature -40° to +70°C (-40° to +158°F)
Humidity 0 to 95% (non-condensing)

DIMENSIONS

Reader 4.5" (h) x 3.2" (w)

CARTON INVENTORY

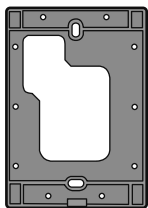

Mounting Plate



PPLX Reader

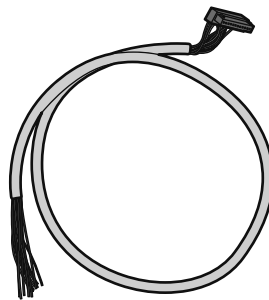

Cable with Wiring Harness



Metal Oxide Varistor (MOV) (1)



#6 Mounting Screws (2)



4x40 Screw (1)



Security Screw (1)

NOT SHOWN

Manual
Log Sheet

ACCESSORIES (NOT PROVIDED)



PPRP Programmer

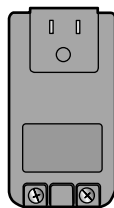

PS12D2A 12 Vdc Plug-In Power Supply

Designed to power the PPLX Reader (90 mA) and other devices as needed up to total of 2.0 Amps. Requires 110 Volts AC power.



PPCSC Passport™ Proximity Cards

INSTALLATION

- 1 Position the mounting plate to the mounting surface and attach with the #6 mounting screws.
- 2 Drill a 3/4" hole for the cable (refer to illustration for location of the cable hole) and feed the cable through the hole as shown.
- 3 Plug the wire harness into the connector on the back of the reader.
- 4 Attach the reader to the mounting plate by inserting the top tabs into the slots on the top of the mounting plate.
- 5 Secure by installing either the 4x40 screw or the security screw into the hole on the bottom of the reader.

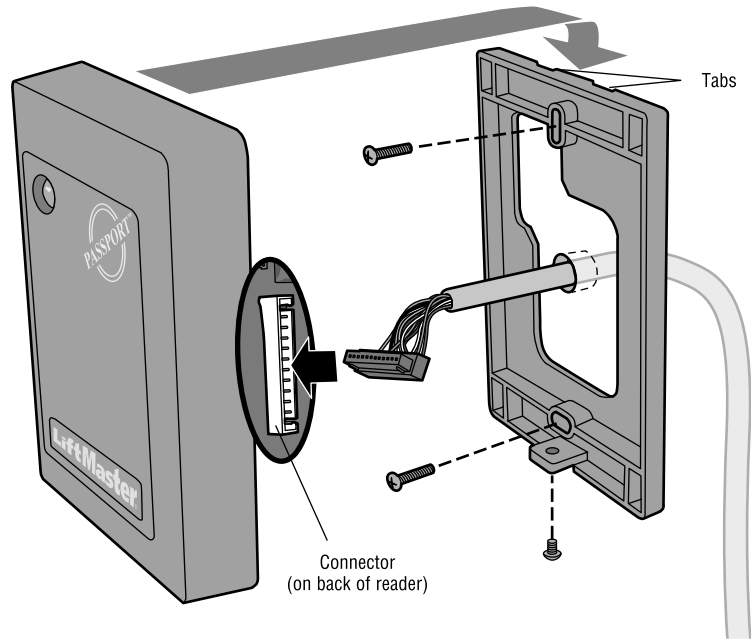

WIRING

LIFTMASTER® CONNECTIONS

PRODUCT	MODEL/TYPE	WHITE/BLACK (RELAY)	WHITE/BROWN (RELAY)	POWER SUPPLY FOR READER	
				BLACK	RED
Maglock	MG1300	MG1300 Lock (Red + White)	MG1300 Transformer (Black + White)	-	+
Commercial Door Operators	Logic 4.0	Terminal 7 (Open)	Terminal 4 (Common)	-	+
	Medium Duty Logic	Terminal 7 (Open)	Terminal 3 (Common)	-	+
Commercial Gate Operators	LiftMaster® Commercial	Terminal 6 (Open)	Terminal 5 (Common)	-	+
	Elite® Commercial	Terminal 10	Terminal 9	-	+
	Mega Operators	Terminal 3 (Open Gate)	Terminal 10 (Common)	-	+
Residential Gate Operators	Miracle-One™	Terminal 21 (Strike Input N/O)	Terminal 10 (Strike Input Common)	-	+
	LA400	SINGLE BUTTON	COM	-	+
	LA412/RSW/RSL	SINGLE BUTTON	CTRL PWR	-	+

WIRING CONNECTIONS

BASIC			ADVANCED		
WIRE COLOR	REMOTE OPEN STANDALONE	LED CONTROL WIEGAND	WIRE COLOR	REMOTE OPEN STANDALONE	LED CONTROL WIEGAND
RED	5-14 Vdc +	5-14 Vdc +	GREEN	DATA-0	DATA-0
BLACK	GROUND -	GROUND -	WHITE	DATA-1	DATA-1
WHITE/BLACK	Latch Relay	N/A	VIOLET	N/A	N/A
WHITE/BROWN	Latch Relay	N/A	GRAY	N/A	N/A
			ORANGE	N/A	GREEN LED INPUT (3, 1)
			BROWN	REX LATCH + TIMER (2,1)	RED LED INPUT (3, 1)
			YELLOW	N/A	BEEPER INPUT (1)
			BLUE	N/A	HOLD (1)

Connect to GROUND to activate (1), Input programmed for Remote Open (2), Input programmed for LED/Beeper Control (3)

WIRING

MAGLOCK/STRIKE

Use separate power supplies for the maglock/strike and the reader.

AC/DC

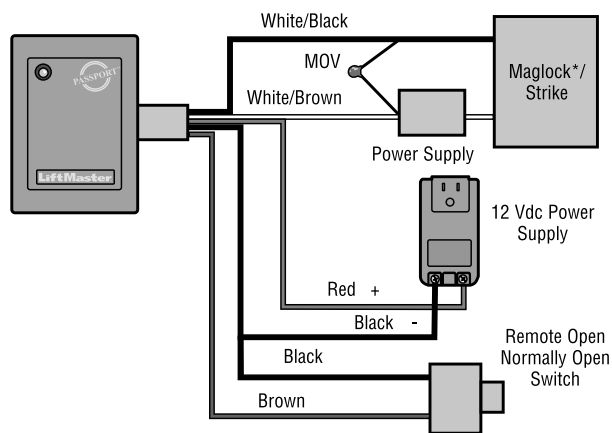

* Relay defaults to Normally Open. For Maglock, refer to Configure Relay Output in the Advanced Programming section.

GATE/DOOR OPERATOR

Use separate power supplies for the reader. Refer to page 2 for wiring details.

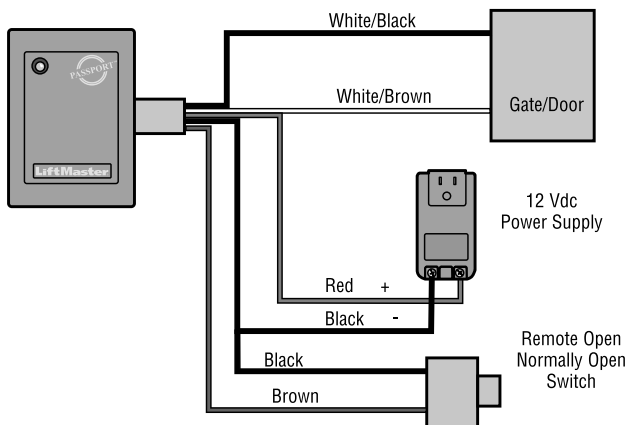

BASIC PROGRAMMING

PROGRAM INITIAL FACILITY CODE

IMPORTANT: These steps **MUST** be completed in order to exit the initial programming mode.

- 1 Plug in the power supply to the reader (LED will flash Red/Green).
- 2 Present a Credential Device such as a Card to the reader to set the Facility Code (flashing will end in approximately 10 seconds).
Credential Devices are pre-encoded and engraved at the factory with a Facility (Site) Code and an individual Credential Device ID number.

Record the name of each person to whom a Credential Device is issued, as well as the ID number of their Credential Device.

BASIC PROGRAMMING

ENTER PROGRAM MODE

The programmer (not provided) is required to program the reader. One programmer may be used on several readers.

TO ENTER PROGRAM MODE USING THE PROGRAMMER:

Enter your password (Default is 12345) and then press "ENTER"
The LED will flash Amber to indicate Program Mode.

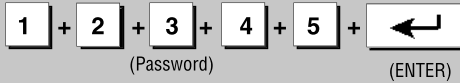

NOTE: The reader will "time out" and return to Active (Normal) Mode in 15 seconds if no programming follows.

If five incorrect passwords are entered, the reader will sound an alarm and display a Red LED for 30 seconds, then return to normal mode.

PROGRAMMER OVERVIEW

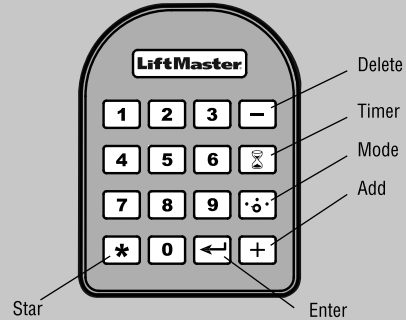

ADD USER

ADD A SINGLE CREDENTIAL DEVICE TO THE SYSTEM

Enter Program Mode. Press ADD, followed by the Credential Device's ID number. Then press Enter. For example, to add Credential Device #00012 to the reader the following sequence would be entered:

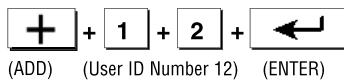

Credential Device #12 is now valid.

ADD A BATCH OF CREDENTIAL DEVICES TO THE SYSTEM

Enter Program Mode. Press ADD, followed by the lowest Device ID number. Then press the "Star" (*) Key, followed by the highest Device ID number. Then press Enter. For example, to add Credential Devices #00001 through #00010 to the system:

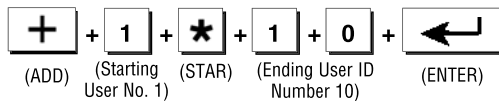

Credential Devices #1 through #10 are now valid.

DELETE USER

DELETE A SINGLE CREDENTIAL DEVICE FROM THE SYSTEM

Enter Program Mode. Press DELETE, followed by the Credential Devices ID number. Then press Enter. For example, to delete Credential Device #00012, the following sequence would be entered:

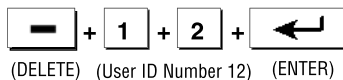

Credential Device #12 has now been deleted.

DELETE BATCH OF CREDENTIAL DEVICES FROM THE SYSTEM

Enter Program Mode. Press DELETE, followed by the lowest Device ID number. Then press the "Star" (*) Key, followed by the highest Device ID number. Then press Enter. For example, to delete Credential Devices #00001 through #00010 from the system:

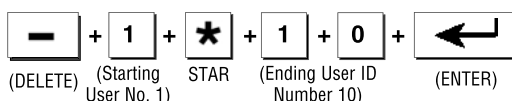

Credential Devices #1 through #10 have now been deleted.

ENABLING/DISABLING CARD TYPES

Normally, the reader will read Passport™, 30 bit Sentex® and 26 bit industry standard proximity cards. To disable or re-enable card types, enter Program Mode then select the desired command:

TO READ ONLY PASSPORT™ PPCSC CARDS

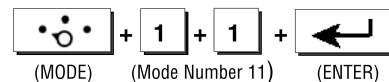

TO READ ONLY 30 BIT SENTEX® AND 26 BIT INDUSTRY STANDARD CARDS

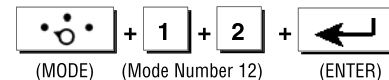

TO READ PASSPORT™, 30 BIT SENTEX®, AND 26 BIT INDUSTRY STANDARD CARDS

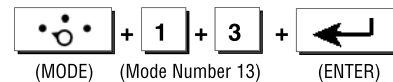

NOTE: Passport™ transmitters CPTK13PH and CPTK33PH include 26 bit industry standard Proximity.

PROGRAM ADDITIONAL FACILITY CODE(S)

Enter "Learn Facility Code" mode by entering the Program Mode then pressing "Mode", followed by "10", followed by Enter.

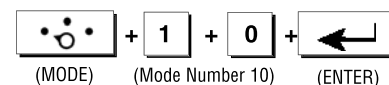

While LED is flashing (Red/Green), present one User Credential Device for each Facility Code being used to the reader, one at a time (up to 10). After you are finished, allow 15 seconds to time out and return to the Normal Mode before proceeding.

NOTES:

- An invalid facility code will beep with no LED visible.
- If it becomes necessary to mix Credential Devices with more than one Facility Code in the same reader, and/or if you combine Passport™ and 26 bit industry standard credential devices, be sure that the Device ID numbers are not duplicated.
- The reader can hold a total of 10 Facility Codes.

ADVANCED PROGRAMMING

PASSWORD

CHANGE YOUR PASSWORD

Enter Program Mode (refer to page 4).

Press the "Star" (*) Key. Then enter the sequence of digits representing the desired new password (exactly 5 digits). Then press the "Star" (*) Key again. Repeat the new password. Press ENTER. A green light and beep means that the Password was changed.

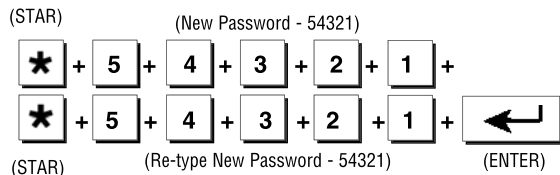

NOTE: "12345" is the default password; change the password for best security.

LOST OR FORGOTTEN PASSWORD

To restore the password to the factory default (12345), disconnect power to the reader and remove it from the mounting plate. "Short" the Data 1 line (white wire) to the Remote Open Line (brown wire). Connect power briefly. Disconnect power and remove the short between the white and brown wire. Connect power. The password is now set to factory default.

This procedure will NOT delete any Credential Devices from reader's memory.

RESTORE FACTORY DEFAULTS

Enter Program Mode.

Press the following Key sequence to return the reader to factory default settings.

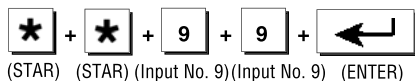

NOTE: All programmed Users and Settings will be eliminated from reader memory.

TIMED ANTI-PASSBACK

Timed Anti-Passback is used to discourage card sharing. After one successful card use, the reader will treat that card as invalid for a preset number of minutes. When timed anti-passback is enabled, it will apply to all valid cards.

ENABLE TIMED ANTI-PASSBACK

Enter Program Mode. Press SET TIMER, then press ADD, then press ENTER.

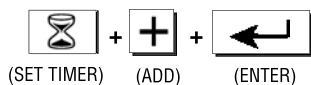

SET ANTI-PASSBACK TIMER

Enter Program Mode. Press SET TIMER then press the "Star" (*) Key. Press the digits representing the maximum number of minutes you want anti-passback to apply (01-99). Press ENTER.

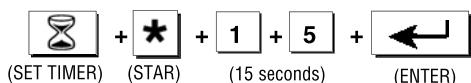

NOTE: Anti-passback can be from one to ninety-nine minutes. Depending upon the clock cycle of the reader when a card is read, the actual anti-passback time may vary.

TIMED ANTI-PASSBACK CONTINUED

DISABLE TIMED ANTI-PASSBACK

Enter Program Mode. Press SET TIMER, then press DELETE, and then press ENTER.

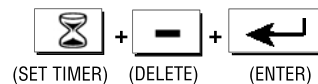

OPERATING MODES

The reader operates in four modes:

1	Active (Normal)	LED is Off	A valid card or closure of the remote open input will activate the relay for the time the latch timer is set.
2	Inactive (Locked)	LED blinks Red	Deactivates the reader. No card can activate the relay, but the remote open input will activate the relay.
3	Door Unlocked	LED blinks Green	Entrance held open (the relay is kept latched).
4	Toggle Mode	LED is Off	A valid card is presented or the remote open input is activated, and changes the relay state from deactivated to activated or from activated to deactivated.

SET THE OPERATING MODE

Enter Program Mode. Press MODE, and then press either "1", "2", "3", or "4". Press ENTER. The reader will exit Programming Mode, and enter the selected Mode. For example, to set the reader to the inactive (locked) mode, the following sequence would be entered:

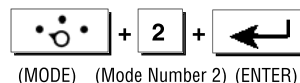

TO EXIT PROGRAMMING MODE IMMEDIATELY

Press MODE, and then "1" (or 2, 3, or 4). Press ENTER. This returns the reader to the selected mode immediately, bypassing the 15-second timeout.

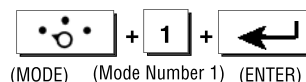

ADVANCED PROGRAMMING

CONFIGURE RELAY OUTPUT (N/O OR N/C)

The reader relay is set at the factory to be normally open and to close upon presentation of a valid Card or upon activation of the remote open (Request to Exit) input, but it may be changed to normally closed operation.

To configure the relay, enter Program Mode. Press the “Star” (*) Key TWICE. Then press either the “6” or “7”. Press ENTER.

OPTIONS

- 6 - Normally Open (Factory default)
- 7 - Normally Closed

For example, to configure the relay normally closed, the following sequence would be entered:

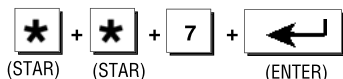

SET THE RELAY LATCH TIMER (STRIKES AND MAGLOCKS)

Enter Program mode. Press SET TIMER, and then press the digits representing the desired Latch Time (0 - 65535 seconds). Press ENTER. A Green LED and beep indicates Latch Timer setting update.

NOTE: Setting Latch Timer for “0” seconds, actually results in a 0.25 second latch time. For example, to set the latch timer to 15 seconds, the following sequence would be entered:

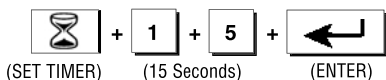

For longer latch times it may be easier to set the timer with hour/minute notation. Press SET TIMER; then press the digits representing the number of hours (2 digits); then press the digits representing the number of minutes; then press the “Star” (*) Key; then press ENTER. (The maximum relay time is 18 hours and 00 minutes.) For example, to set the latch timer for 2 hours and 45 minutes the following sequence would be entered:

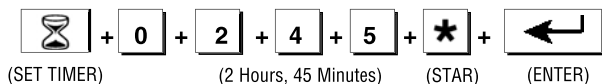

If you have set an extended latch time, but need to interrupt it, use the following procedure:

Enter Program Mode. Then press SET TIMER, then “1”, and then Enter. After the Program Mode “times out” (15 sec), present a valid card to the reader.

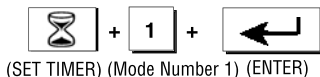

After one second, the relay will return to its normal state.

NOTE: You will then have to reprogram the latch timer to the desired time.

The latch timer controls the reader relay. The Default latch time is 1 second, but it can be set to any value from 0.25 seconds to 18 hours. If it is set to 0 seconds, this pulses the reader relay for 0.25 second, sufficient for most gate and door operators.

The beeper and LED are always fixed at one second.

USING THE READER AS A WIEGAND OUTPUT READER

The reader can be connected to a multi-door access control system using the Wiegand output. When any 34 bit Passport™, 26 bit industry standard or 30 bit Sentex® credential device is presented to the reader, whether or not it has been programmed to the reader, the appropriate Credential Device ID will be sent out via the white and green wires.

PROGRAMMING THE INPUTS

The reader input is set at the factory as the Remote Open input. Connecting the brown and black/ground wire (usually through a normally-open push button switch or the contacts from an Exit input) will activate the relay for as long as the button is held, plus the time set for the latch timer. This input may also be configured as an LED Control, in which case grounding the brown wire will turn on the red LED, and grounding the orange wire will turn on the green LED. Additionally, grounding the yellow wire will turn on the beeper, and grounding the blue wire will activate the card data Hold function.

To configure the input, enter Program Mode. Press the “Star” (*) Key TWICE. Then press either the “1” or “2” button. Press ENTER. Selections are:

- 1 – Remote Open (Factory Default – Standalone operation)
- 2 – LED Control (Standard Wiegand Reader Interface)

For example, to program the input for LED control, the following sequence would be used:

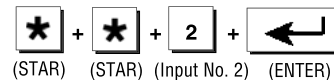

OPERATION

USING WIEGAND ACCESS CARDS & TRANSMITTERS WITH THE READER

To use the reader, simply hold your Credential Device near the reader. The reader generates a short range RF field, which causes the Credential Device to send a unique ID Number back to the reader.

If the Credential Device ID Number is stored in memory, the latch relay is activated. A Green light and a beep indicate that access is granted. If the device ID Number is not stored in memory, the relay remains inactive, and a Red light and beep indicate that access is denied. Otherwise, the LED is normally off.

THE READER IS COMPATIBLE WITH THE FOLLOWING LIFTMASTER® WIEGAND CREDENTIALS:

- Passport™: PPCSC (Card), CPTK13PH & CPTK33PH (Transmitter)
- Sentex®: SNACPH3x & SNACPHISO3x (Card), SNACPKH3x (Transmitter)
- LiftMaster® Q: CACC & CACISO (Card)

REMOTE OPEN (REQUEST TO EXIT) INPUT

When the Remote Open input is activated, the relay will activate. When the Remote Open input is deactivated, the relay will return to the inactive state after the latch timer times out. A Green LED and a beep indicate that access is granted.

USING THE READER AS A WIEGAND OUTPUT READER

The reader can be connected to a multi-door access control system (such as the LiftMaster® Q2010 Site Control System) using the Wiegand output. When any LiftMaster® Credential Device is presented to the reader, whether or not it has been programmed into the reader, the appropriate Credential Device ID will be sent out via the white and green wires. Refer to “Configure the Reader Input” to control the LED.

TROUBLESHOOTING

LED IS FLASHING RED AND GREEN:

- a. No facility code has been programmed into the reader.**

Present a card. You will hear a beep, then the LED will stop flashing in 10 seconds.

- b. LED is still flashing. Check the card type, it must be 34 bit Passport™, 30 bit Sentex®, or 26 bit industry standard Credential Device.**

CANNOT ENTER PROGRAMMING MODE:

- a. LED is flashing red and green. No facility code has been programmed into the reader.**

Present a card. You will hear a beep, then the LED will stop flashing in 10 seconds.

- b. LED is solid green**

The remote open input is turned on (black & brown wires are shorted). Remove the short.

- c. Default Password (12345) has been changed.**

Refer to Password in the Advanced Programming section.

CARDS DO NOT UNLOCK THE DOOR:

Card reader beeps, LED flashes Red once. The cards have not been programmed into the reader.

Refer to Add User in the Basic Programming section.

**INSTRUCTION TO THE USER
FCC ID: NNHDTR1**

This device complies with Part 15 of the FCC Rules. Operation is subject to the following two conditions: (1) this device may not cause harmful interference, and (2) this device must accept any interference received, including interference that may cause undesired operation. This equipment has been certified to comply with the limits for a class B computing device, pursuant to FCC Rules. In order to maintain compliance with FCC regulations, shielded cables must be used with this equipment. Operation with non-approved equipment or unshielded cables is likely to result in interference to radio and TV reception. The user is cautioned that changes and modifications made to the equipment without the approval of the manufacturer could void the user's authority to operate this equipment.

ONE YEAR LIMITED WARRANTY

The Chamberlain Group, Inc, warrants to the first retail purchaser of this product that it is free from defect in materials and/or workmanship for a period of 1 year from the date of purchase.

**FOR TECHNICAL SUPPORT
DIAL OUR TOLL FREE NUMBER:**

1-800-528-2806

www.liftmaster.com