

**amazon**  
basics

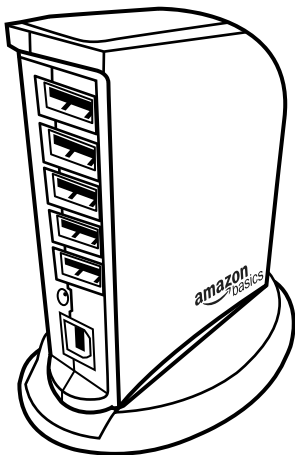

**B00DQFGJR4**



---

2





## Instruction Manual

### AmazonBasics USB 2.0 7-Port Hub

---

#### Contents

- USB 2.0 7-Port Hub
- 5V 4A power adapter
- USB cable
- This instruction manual

#### System Requirements

- Available USB port
  - Windows® 8, Windows® 7, Windows Vista®, Windows® XP, Windows® 2000, or Mac OS X
-

## Features

- Transfer data
- Power surge protection
- Charge up to seven devices
- Two USB ports for high-power devices

## Product overview

### Front

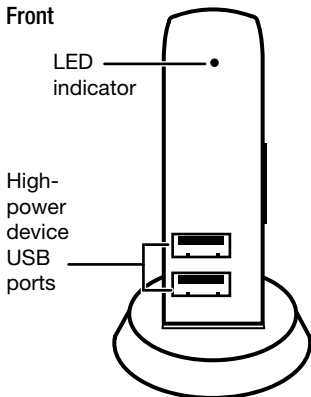

### Back

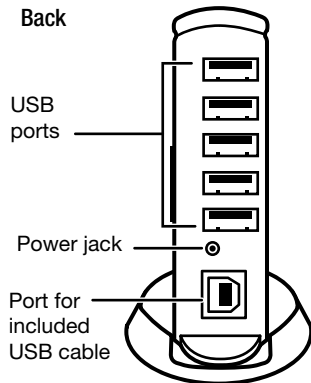

## Attach the stand

Horizontal

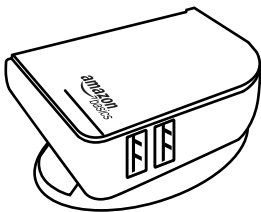
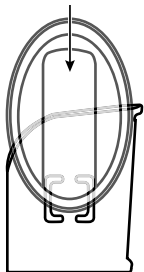

Vertical

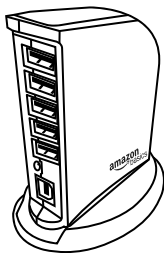
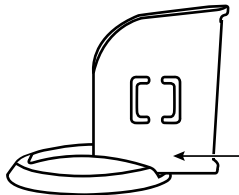

## Connect the hub:

1. Turn on your computer.

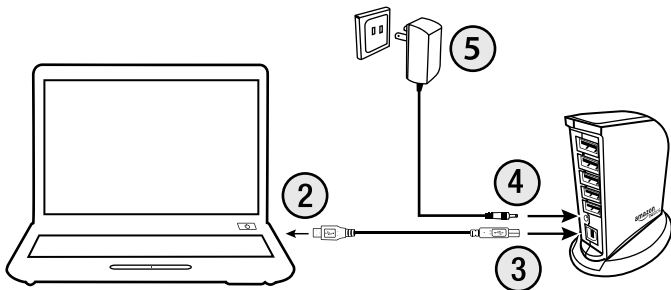

2. Connect the hub's USB cable to an available USB port on your computer.
  3. Connect the other end into the square port on the hub.
- For additional power:**

4. Connect the power adapter into the hub's power jack.
  5. Connect the other end to a power outlet.
- Drivers install automatically. Once installed, you can begin using the hub.

## Usage

Insert USB devices into the hub to charge or to transfer data.

**Note:** For the best performance, connect your hub to a USB 2.0 port. If you use a USB 1.1 port, data transfer will be slower.

## Power Surge Protection

If a power surge occurs:

- The power to the hub is disconnected and the red LED indicator turns off.
- The “USB Hub Current Limit Exceeded” window opens. Click **Reset** to resume work, or unplug the USB cable, then plug it back in.

## Troubleshooting

### Hub will not recognize my USB device.

- Make sure the USB cable is securely connected to your hub and computer.
- Try connecting the hub to a different USB port on your computer.
- Connect the power adapter from the hub to a power outlet.
- Make sure your power outlet is working.
- Plug your USB device directly into a USB port on your computer. If your computer does not recognize the device, the problem is with your device.

- Make sure you have the most recent updates for your operating system.

### **Connection is slow**

- Make sure the hub is connected to a 2.0 USB port on your computer. When connected to a USB 1.1 port, the hub operates at slower speeds.
- Connect the power adapter to the hub and a working power outlet.

### **USB device will not charge**

- Connect the power adapter to the hub and a working power outlet.
- Make sure the USB cable is securely connected to your hub and computer.
- Use one of the two USB ports on the front for high-power charge.

### **Hub disconnects from computer**

- Make sure the USB cable is securely connected to your hub and computer.
- Connect the power adapter to the hub and a working power outlet.
- Try connecting the hub to a different USB port on your computer.
- Check your computer's sleep or standby settings.



**WEEE****Regulatory Information: Disposal of Waste Electrical and Electronic Equipment (WEEE)**

The Waste Electrical and Electronic Equipment (WEEE) Directive aims to minimize the impact of electrical and electronic goods on the environment, by increasing re-use and recycling and by reducing the amount of WEEE going to landfill. The symbol on this product or its packaging signifies that this product must be disposed separately from ordinary household wastes at its end of life. Be aware that this is your responsibility to dispose of electronic equipment at recycling centers in order to help conserve natural resources.

Each country should have its collection centers for electrical and electronic equipment recycling. For information about your recycling drop off area, please contact your related electrical and electronic equipment waste management authority, your local city office, or your household waste disposal service.

**FCC Information**

This equipment has been tested and found to comply with the limits for a Class B digital device, pursuant to Part 15 of the FCC Rules. These limits are designed to provide reasonable protection against harmful interference in a residential installation. This equipment generates, uses and can radiate radio frequency energy and, if not installed and used in accordance with the instructions, may cause harmful interference to radio communications. However, there is no guarantee that interference will not occur in a particular installation. If this equipment does cause harmful interference to radio or television reception, which can be determined by turning the equipment off and on, the user is encouraged to try to correct the interference by one or more of the following measures:

- Reorient or relocate the receiving antenna.
- Increase the separation between the equipment and receiver.
- Connect the equipment into an outlet on a circuit different from that to which the receiver is connected.
- Consult the dealer or an experienced radio/TV technician for help.

Changes or modifications not expressly approved by the party responsible for compliance may cause interference and void the user's authority to operate the equipment.

This device complies with Part 15 of the FCC Rules. Operation is subject to the following two conditions: (1) This device may not cause harmful interference, and (2) this device must accept any interference received, including interference that may cause undesired operation.







amazon  
basics

13-0820