



BEST FOR CATS
& SMALL DOGS



PET WATER FOUNTAIN

with Ultrafiltration Technology

Model Number: DF03



EFFECTIVE REMOVAL
OF WATER BACTERIA

Visit www.dogcare.net to
learn more about our
ultrafiltration filter sets

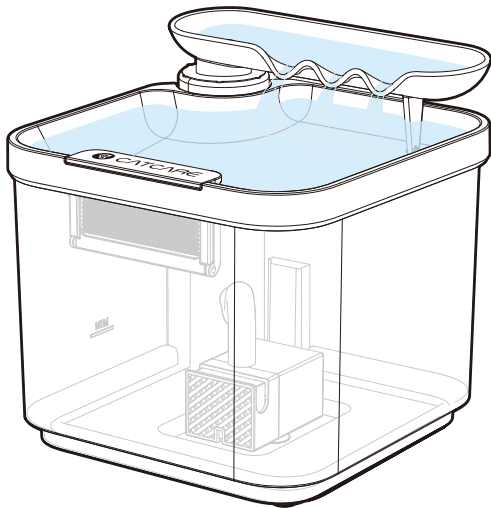

DogCare Inc.

HUMAN & ANIMAL BOND



IMPORTANT SAFETY INSTRUCTIONS

BEFORE USING THIS PRODUCT READ ALL INSTRUCTIONS AND WARNINGS IN THIS MANUAL.

⚠ WARNING

To reduce the risk of burns, fire, electric shock, or injury to persons:

1. To reduce the risk of injury, close supervision is necessary when an appliance is used by or near children.
2. To protect against electric shock, do not place electrical power cord or plug in water or other liquids.
3. Do not operate any appliance if it has a damaged electrical power cord or plug, or if it is malfunctioning or has been damaged. Contact customer support for further instructions.
4. To reduce the risk of electric shock, do not place or store an appliance where it can fall or be pulled into a bathtub or sink.
5. Always unplug any appliance when not in use, before putting on or taking off parts and before cleaning.
6. Do not use an appliance for anything other than its intended use.
7. If the plug of this device gets wet, turn off the electricity to that electrical outlet. Do not attempt to unplug.
8. Examine this appliance after installation. Do not plug into electrical outlet if there is water on the electrical power cord or plug.

CAUTION

1. Do not allow pets to chew on or swallow any parts. If you are concerned your pet may chew the power cord, purchase a cord conduit (a hard plastic protector) at any hardware store.
2. The plastic fountain parts are BPA-free. However, some animals have been known to be sensitive to plastic food and water containers. If your animal shows signs of an allergic reaction to the plastic, please discontinue use until you have consulted with your veterinarian.

NOTICE

1. The fountain is intended to run continuously (always plugged into an electrical outlet), as long as the water level is maintained and the fountain is cleaned regularly. Be sure to check the water level regularly to help prevent damage to the pump, as your pet will drink the water, and some may evaporate.
2. Do not attempt repairs on the pump.
3. Do not pull on the electrical power cord to remove the plug from the electrical outlet. To unplug, grasp the plug, not the electrical power cord.
4. To avoid the possibility of the plug or electrical outlet getting wet, the electrical outlet should always be above the level of the fountain.
5. If an extension cord is necessary, an extension cord with a proper rating should be used.
6. The electrical use of this appliance is 0.5 watts.
7. The use of attachments not recommended or sold by the manufacturer may cause an unsafe condition. Do not modify the appliance.
8. Do not install or store appliance where it will be exposed to weather or temperatures below 32 °F. Read and observe all important notices listed on the appliance and in the packaging.
9. Use only CatCare replacement filters. If unauthorized filters are used, the warranty may be voided.
10. Do not use outdoors. Do not run dry. For indoor household use only.

READ AND SAVE THESE INSTRUCTIONS

In the Box



**Not
dishwasher
Safe**

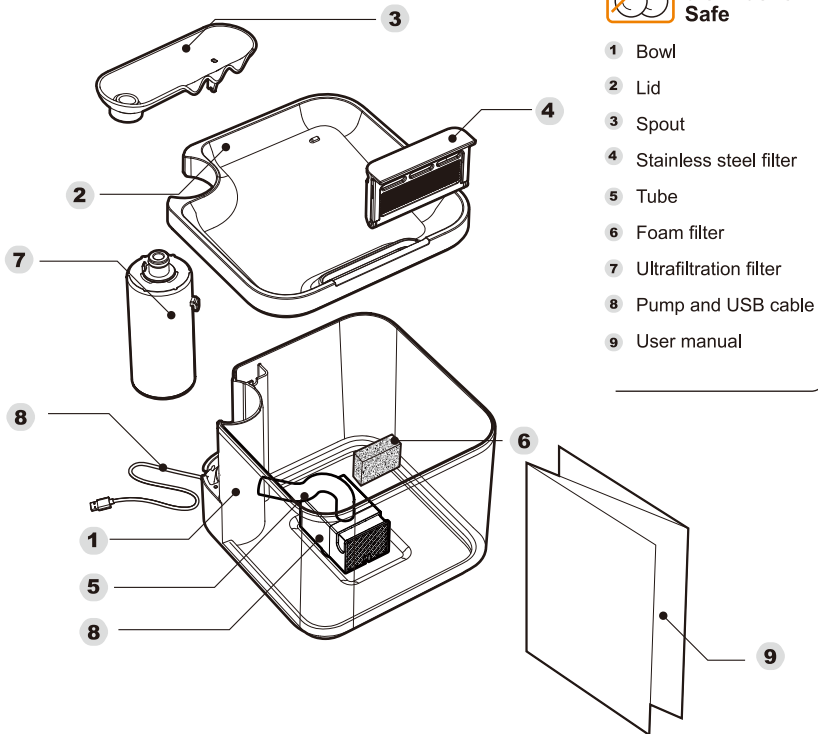

Setting up

1. Clean the water fountain before first use

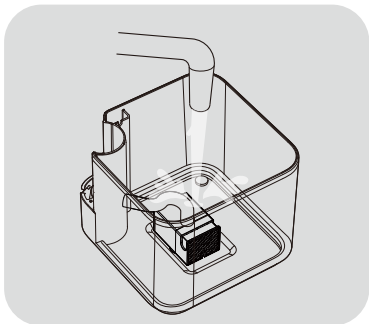

Wash the fountain parts, except the ultrafiltration filter.

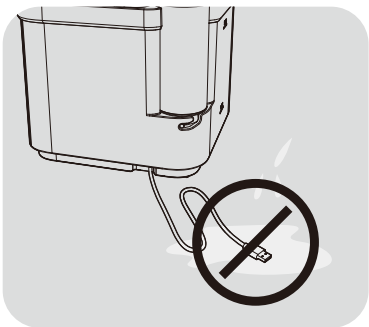

Note: do not wash the USB part of the power cable.

2. Connect the tube

1. Affix the short end of the tube to the pipe on the pump. Make sure the tube is pressed all the way down.
2. Then affix the long end of the tube to the pipe in the bowl. Make sure the tube is pressed all the way in.

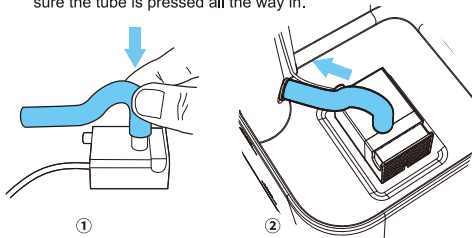

3. Fix the pump

With the pipe connected, put the pump in place and suction it to the bottom of the bowl.

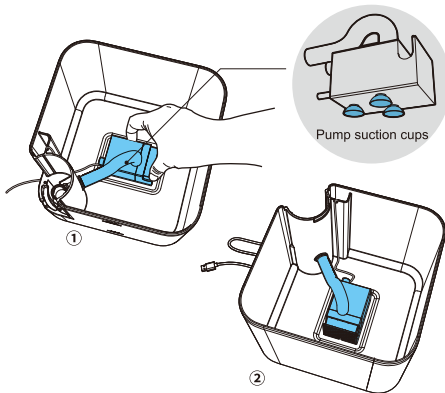

4. Arrange the USB cable

Feed the USB cable through the opening on the inside of the bowl. Fix the cable through the slot.

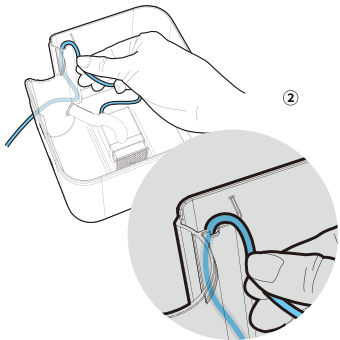
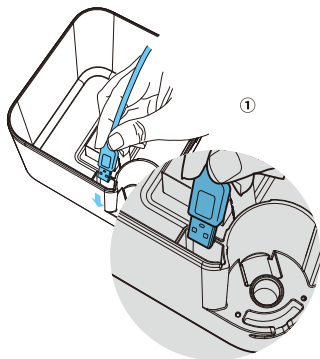

5. Set the ultrafiltration filter start date

Rotate the date indicator wheel on top of the ultrafiltration filter and record the date when you start using the filter. It helps to keep track of when to replace the filter. The ultrafiltration filter needs to be replaced every three months, as described in Filters.

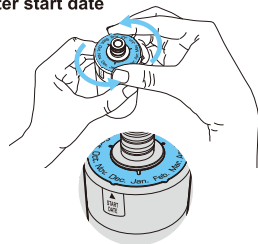

6. Install the ultrafiltration filter

Hold the ultrafiltration filter with the CatCare logo facing upward. Attach the filter by running the knob down along the slot on the bowl until the knob reaches the end of the slot.

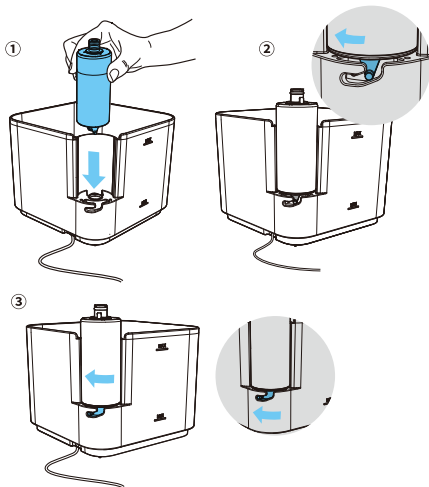

7. Fill the bowl with water

1. Pour drinking water into the bowl until the water level is above the MIN fill-line and below the MAX fill-line. The water temperature should not exceed 95 °F.
2. Close the lid over the bowl.

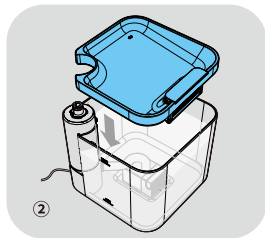
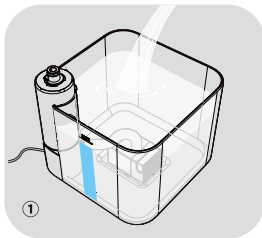

8. Install the spout

Attach the spout to the top of the ultrafiltration filter.

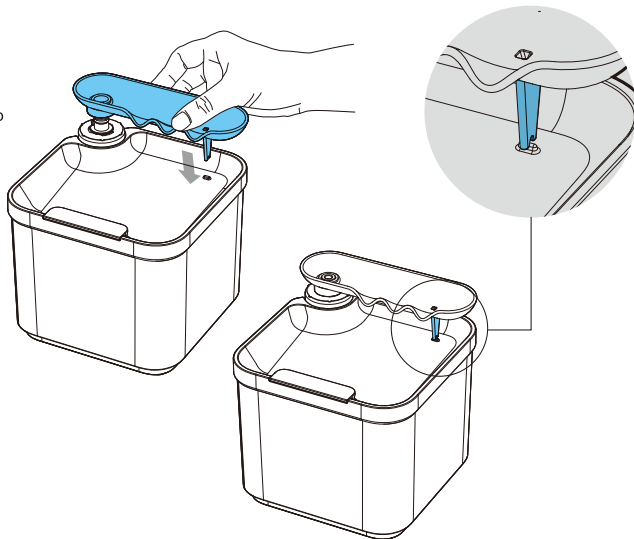

9. Place the fountain in a desired location

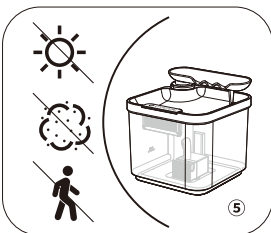
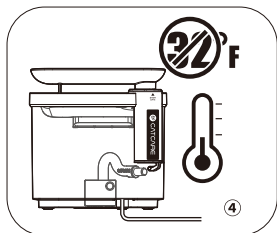
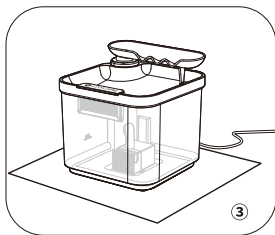
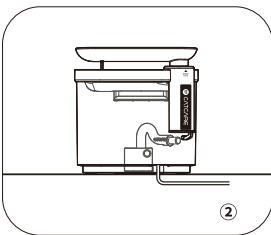

1. The water fountain is intended for indoor household use.
2. Place the water fountain on flat ground. To prevent it from falling, do not put it in a high place.
3. Protect your floors from spills and splashes that can be caused by your pet; if placing on carpet, tile or wood, always use a protective mat.
4. Do not operate the fountain in temperatures below 32 °F.
5. Try to choose a location where there is no direct sunlight, less dust, and no people (especially strangers to pets) passing by frequently.

10. Connect the USB cable

Make sure the USB cable and your hands are completely dry. Connect the USB cable to any relevant USB port—computer ports, portable power banks, existing USB power adapters, etc. The water fountain will turn on once connected to power.

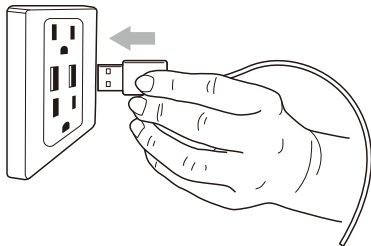

Tips on Use

My pet won't drink from the water fountain

- Your pet may be cautious of his/her new water fountain. Some pets may take several days or longer to begin use, while others will start right away. Simply allow several days or longer for your pet to adapt to the water fountain.
- Try changing the location of the water fountain. Your pet may prefer that the fountain be placed away from their normal feeding area. Try placing it in another location, such as a different area of the kitchen or in a bathroom or utility room.

Cleaning

To maintain the quality of drinking water and keep your pet healthy, we recommend that you change the water as frequently as possible and clean the water fountain at the same time.

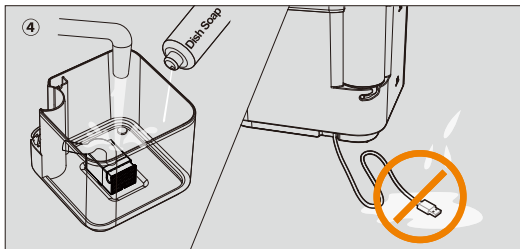
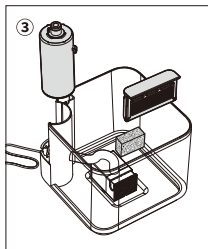
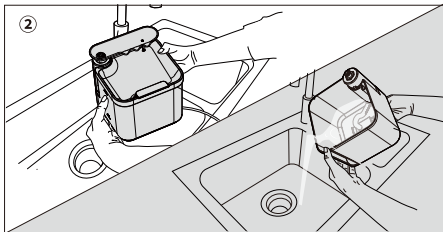
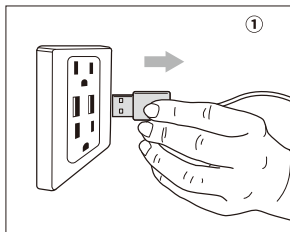

NOTE: the fountain parts are NOT dishwasher safe.

1. Unplug the water fountain.
2. Pick up the water fountain by the bowl, and take it to the sink. Remove the lid and pour water out of the bowl.
3. Disassemble the water fountain and detach the ultrafiltration filter, stainless steel filter, and foam filter. Do not remove the ultrafiltration filter if there is still water in the bowl, as water may flow out.
4. Hand wash the fountain parts, except the ultrafiltration filter, with mild detergent and rinse thoroughly. You can rinse the ultrafiltration filter with clean water. Prevent the USB part of the power cable from getting wet when washing the pump.
5. Reassemble the water fountain.

Filters

Your pet water fountain is equipped with three types of filters and the filters together will provide optimal filtration for your pet. The stainless steel filter and the foam filter catch hair and debris. The ultrafiltration filter removes bacteria, bad tastes and odors, and other harmful contaminants from clean water.

The filters should be cleaned or replaced on a regular basis:

1. Stainless Steel Filter

- Clean as needed—when fountain is cleaned and in between cleanings.
- Uninstall and open the stainless steel filter, remove hair and debris collected, and rinse out with water.

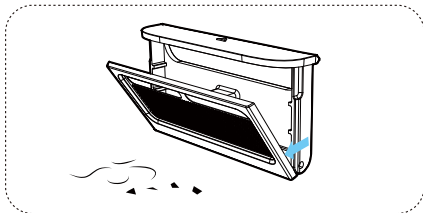

2. Foam Filter

- Replace the foam filter every three months. You can purchase the replacement filter by visiting <https://www.dogcare.net> or DogCare's Amazon store.
- If you do not intend to replace the filter at the time of cleaning, detach the filter from the pump and rinse thoroughly with water.

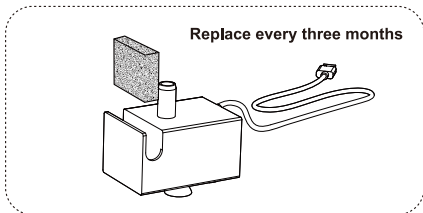

3. Ultrafiltration Filter

- Replace the ultrafiltration filter every three months, depending on the environment where the water fountain is used and the number of pets using it. You can purchase the replacement filter by visiting <https://www.dogcare.net> or DogCare's Amazon store.
- You can rinse the ultrafiltration filter with clean water.
- Due to the unique nature of ultrafiltration technique, the ultrafiltration filter begins to consume its service life once it gets wet. If you have not used the water fountain for a prolonged period of time, please replace the ultrafiltration filter the next time you use it.

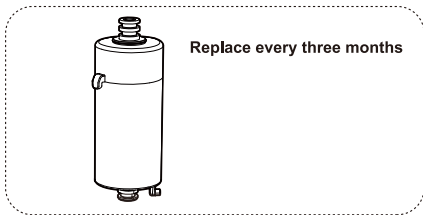

Troubleshooting

Problem	Solutions
Will not turn on or stops working	<ul style="list-style-type: none">▪ Check that the household electrics are on—test by plugging in another appliance.▪ Check that the outlet is working.▪ Check the power cable for signs of damage. If damaged, stop using and contact DogCare Customer Support.
Decreased water flow	<ul style="list-style-type: none">▪ Check the water level in the bowl. Add water if the water level is lower than the MIN fill-line.▪ The foam filter may be clogged. Wash or replace the filter.▪ The ultrafiltration filter may be clogged. Replace the filter.
Unusual odor	<ul style="list-style-type: none">▪ Change the water as frequently as possible and clean the water fountain as described in Cleaning.▪ Clean and wash the stainless steel filter as needed. Replace the ultrafiltration filter and the foam filter every three months.
Unusual noise	<ul style="list-style-type: none">▪ Check the water level in the bowl. The pump might make suction noise if the water level is below the MIN fill-line. Add water until the water level is above the MIN fill-line.
Pet will not drink from water fountain	<ul style="list-style-type: none">▪ Your pet may be more cautious of his/her new water fountain. Some pets may take several days or longer to begin use, while others will start right away. Simply allow several days or longer for your pet to adapt to the water fountain.▪ Try changing the location of the water fountain. Your pet may prefer that the fountain be placed away from their normal feeding area. Try placing it in another location, such as a different area of the kitchen or in a bathroom or utility room.

If the problem is still not resolved after trying the above solutions, please speak to DogCare Customer Support Team. Do not disassemble the pump, as incorrect reassembly may result in an electric shock or fire.

Contact Us

Live Chat

Talk with us directly using live chat anytime.



◀ Scan the QR code to access

Phone

1-833-220-1900

Our helpline hours:

- 9am - 9pm EST, 6am - 6pm PST
- 7 days a week

Email

catcare@afterservice.vip

To help us address your inquiry as quickly as possible, please include the following in your email:

- Your name
- Phone number
- Product name or model number

We will respond to your inquiry within 12 hours.

Guarantee Terms and Conditions

DOG CARE CUSTOMER CARE

Thank you for choosing to buy a DogCare product.

Your DogCare product will be covered for parts (excluding the foam filter and the ultrafiltration filter) and labor for 12 months from the date of purchase, subject to the terms of the guarantee. However, indispensable legal rights of the final consumer under applicable national legislation governing the sales of consumer goods are not affected by the terms of the guarantee.

Your product may be eligible for an extended warranty when you register on DogCare's official website. Please visit www.dogcare.net to find out more.

LIMITED 12-MONTH WARRANTY

Terms and conditions of the DogCare 12-month limited guarantee.

WHAT IS COVERED

Your DogCare product is warranted against original defects in materials and workmanship for a period of 12 months from the date of purchase or delivery, when used in accordance with the DogCare User Manual. Please retain your proof of purchase.

This warranty provides, at no extra cost to you, all labor and parts (excluding the foam filter and the ultrafiltration filter) necessary to ensure your product is in proper operating condition during the warranty period (if any part is no longer available or out of manufacture, DogCare will replace it with a functional replacement part).

This warranty is only valid if the product is used in the country in which it was sold.

WHAT IS NOT COVERED

DogCare shall not be liable for costs, damages or repairs incurred as a result of, due to, or from:

- Accidental damage, faults caused by negligent use or case, misuse, neglect, careless operation or handling of the product which is not in accordance with the DogCare User Manual.
- Use of the product for anything other than normal domestic household purposes.
- Use of parts not assembled or installed in accordance with the DogCare User Manual.
- Use of parts and accessories other than those produced or recommended by DogCare.
- Faulty installation (except where installed by DogCare).
- Repairs or alterations carried out by unauthorized parties or agents.
- Normal wear and tear (e.g. filters etc.).

If you are in any doubt as to what is covered by your warranty, please contact DogCare.

WARRANTY LIMITATIONS AND EXCLUSIONS

To the fullest extent permitted by applicable law, any implied warranties relating to your product including but not limited to warranty of merchantability or warranty of fitness for a particular purpose, are limited to the duration of this warranty.

To the fullest extent permitted by applicable law, your remedy for breach of this warranty is limited to the warranty service described below. DogCare will not be liable for any consequential damages or incidental damages you may incur in connection with your purchase and use of your product. This limited warranty gives you specific legal rights. You may also have other rights which vary by State.

This limited warranty is not transferable.

CONFORMITY INFORMATION

This equipment has been tested and found to comply with the limits for a Class B digital device, pursuant to part 15 of the FCC Rules. These limits are designed to provide reasonable protection against harmful interference in a residential installation. This equipment generates, uses and can radiate radio frequency energy and, if not installed and used in accordance with the instructions, may cause harmful interference to radio communications. However, there is no guarantee that interference will not occur in a particular installation. If this equipment does cause harmful interference to radio or television reception, which can be determined by turning the equipment off and on, the user is encouraged to try to correct the interference by one or more of the following measures:

- Reorient or relocate the receiving antenna.
- Increase the separation between the equipment and receiver.
- Connect the equipment into an outlet on a circuit different from that to which the receiver is connected.
- Consult the dealer or an experienced radio/TV technician for help.

Changes or modifications not expressly approved by the party responsible for compliance could void the user's authority to operate the equipment.

Technical Specifications

Product Name	CatCare Pet Water Fountain
--------------	----------------------------

Model Number	DF03
--------------	------

Weight	24.7 oz
--------	---------

Dimensions	6.9" x 6.6" x 5.7"
------------	--------------------

Capacity	85 oz/ 0.7 gallon
----------	-------------------

Input	DC 5V/1A
-------	----------

Power	0.5W
-------	------

Power Interface	USB
-----------------	-----

Operating Ambient Temperature	32 °F to 104 °F
-------------------------------	-----------------

Relative Humidity	< 95%
-------------------	-------



DogCare Inc.

HUMAN  ANIMAL BOND



DOG CARE



CAT CARE



FISH CARE

www.dogcare.net

 +1-833-220-1900

 9am – 9pm EST, 6am – 6pm PST



dogcare@afterservice.vip



[@dogcareglobal](https://www.facebook.com/dogcareglobal)



[@dogcare_global](https://www.instagram.com/dogcare_global)