

# Left Corner Chair Assembly

B\*1

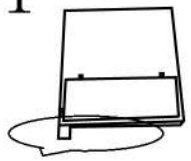

P\*1



Leg in left

T\*1

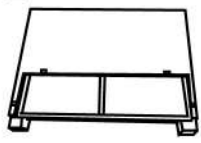

Armrest

E\*8



F\*8

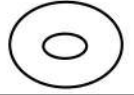

G\*4



H\*1

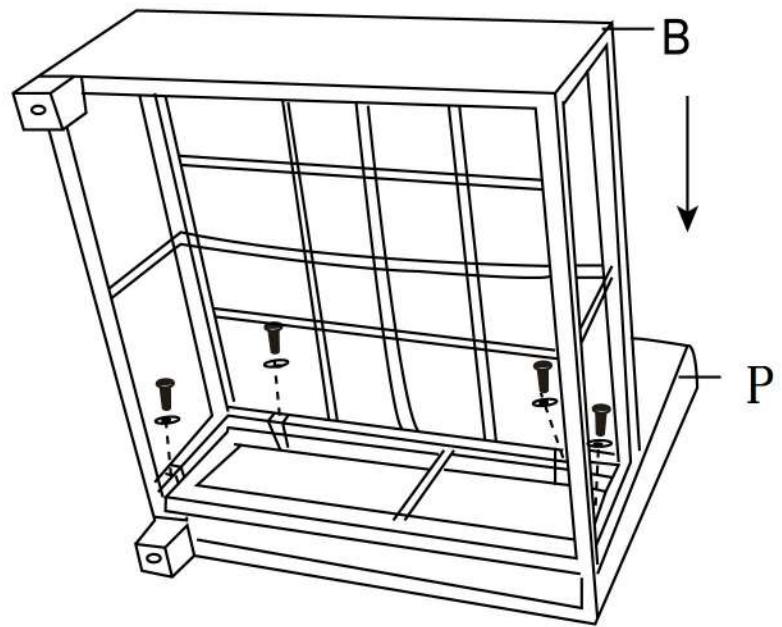

STEP1

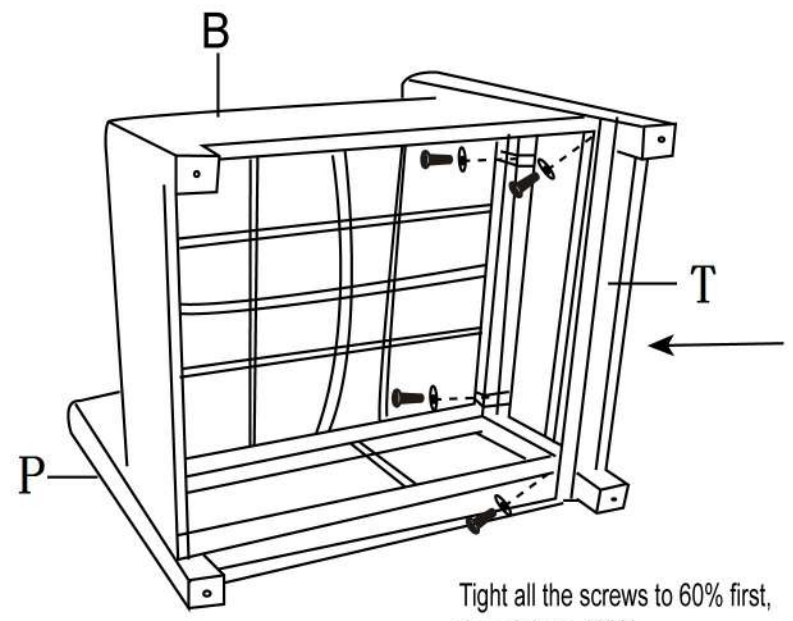

STEP2

Tight all the screws to 60% first, then tight to 100%.

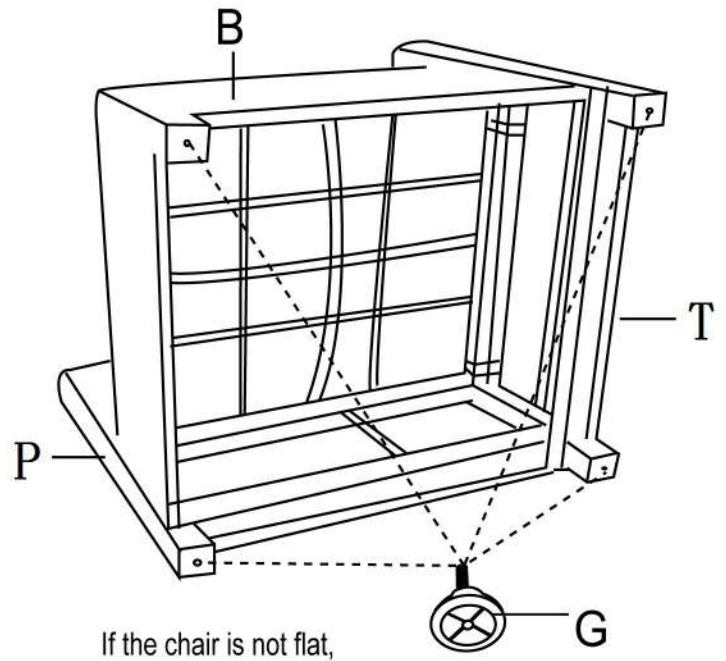

STEP3

If the chair is not flat, pls adjust the foot plug.

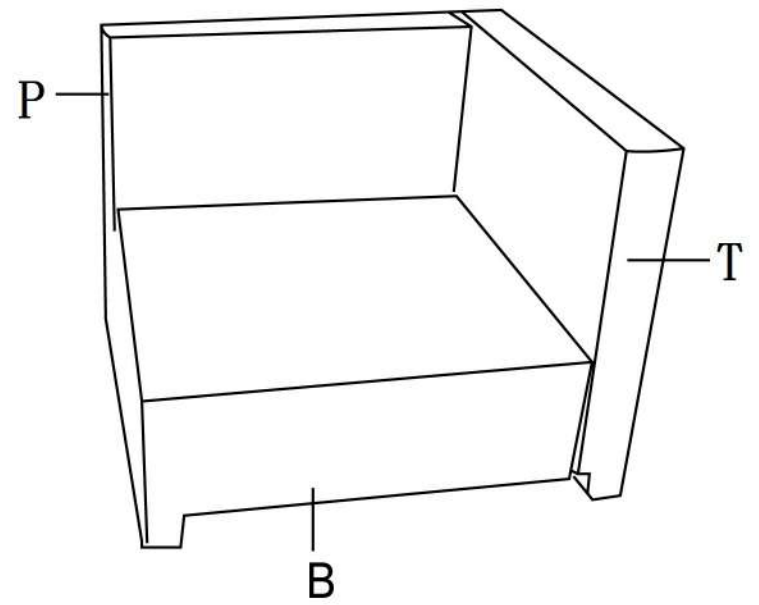

STEP4

# Middle Chair Assembly

