

Register your product and get support at
www.philips.com/welcome

GoGear

SA1VBE02

SA1VBE04

SA1VBE08

SA1VBE16



EN User manual

PHILIPS

Contents

1	Important safety information	3		
	General maintenance	3		
	Recycling the product	4		
2	Your new GoGear Vibe	6		
	What's in the box	6		
3	Getting started	7		
	Overview of the controls and connections	7		
	Overview of the main menu	7		
	Install software	8		
	Connect and charge	8		
	Connect GoGear Vibe to a computer	8		
	Battery level indication	9		
	Disconnect GoGear Vibe safely	9		
	Turn GoGear Vibe on and off	9		
	Automatic standby and shut-down	9		
4	Use GoGear Vibe to carry files	10		
5	Windows Media Player 11 (WMP11)	11		
	Install Windows Media Player 11 (WMP11)	11		
	Transfer music and picture files to WMP11 library	11		
	Switch between music and pictures library in WMP and GoGear Vibe	12		
	Rip songs from a CD	12		
	Buy music online	13		
	Sync your Windows Media content to GoGear Vibe	13		
	Set up GoGear Vibe for WMP11	13		
	Switch between automatic and manual sync	14		
	Select and prioritize what syncs automatically	14		
	Select files and playlists for manual sync	15		
	Copy files from GoGear Vibe to your computer	15		
	WMP11 playlists	15		
	Create a regular playlist	16		
	Create an auto playlist	16		
	Edit playlist	16		
	Transfer playlists to GoGear Vibe	17		
	Search for music or pictures with WMP11	17		
	Delete files and playlists from WMP11 library	17		
	Delete files and playlists from GoGear Vibe	17		
	Edit song information with WMP11	18		
	Format GoGear Vibe with WMP11	18		
6	Music	19		
	Listen to music	19		
	Find your music	19		
	Delete music tracks	19		
7	Audiobooks	20		
	Add audiobooks to GoGear Vibe	20		
	Audiobook controls	20		
	Select audiobook by book title	20		
8	Video	21		
	Download, convert and transfer videos	21		
	Play videos	21		
	Delete videos	21		
9	Pictures	22		
	View pictures	22		
	View slideshow	22		
	Add pictures to GoGear Vibe	22		
	Delete pictures	22		
10	Radio	23		
	Listen to FM radio	23		
	Manually tune a radio station	23		
	Auto-tune preset radio station	23		
	Play a preset radio station	23		

11 Recordings	24
Record from FM radio	24
Record audio/voices	24
Listen to FM recordings	24
Listen to voice/audio recordings	24
Upload your recordings to a computer	25
Delete recordings	25

12 Settings	26
--------------------	----

13 Update GoGear Vibe	28
Manually verify / update firmware	28

14 Troubleshooting	29
---------------------------	----

15 Technical data	30
System requirements	30
Supported music file formats	30
Supported video file formats	30
Supported picture file formats	31

16 Glossary	32
--------------------	----

Need help?

Please visit

www.philips.com/welcome

where you can access a full set of supporting materials such as the user manual, the latest software updates, and answers to frequently asked questions.

1 Important safety information

General maintenance

! Caution

- To avoid damage or malfunction:
- Do not expose the product to excessive heat caused by heating equipment or direct sunlight.
- Do not drop the product or allow objects to fall on your player.
- Do not allow the product to be submerged in water. Do not expose headphone socket or battery compartment to water, as water entering the set may cause major damage.
- Active mobile phones in the vicinity may cause interference.
- Back up your files. Ensure that you retain the original files you have downloaded to your device. Philips is not responsible for any loss of data if the product becomes damaged or not readable / legible.
- Manage (transfer, delete, etc.) your music files only with the supplied music software to avoid problems.
- Do not use any cleaning agents containing alcohol, ammonia, benzene, or abrasives as these may harm the product.

About operating and storage temperatures

- Operate in a place where temperature is always between 0 and 35°C (32 to 95°F)
- Store in a place where temperature is always between -20 and 45°C (-4 to 113°F).
- Battery life may be shortened in low temperature conditions.

Replacement parts/accessories:

Visit www.philips.com/support to order replacement parts/accessories.

Hearing Safety



Listen at a moderate volume:

Using headphones at a high volume can impair your hearing. This product can produce sounds in decibel ranges that may cause hearing loss for a normal person, even for exposure less than a minute. The higher decibel ranges are offered for those that may have already experienced some hearing loss.

Sound can be deceiving. Over time your hearing 'comfort level' adapts to higher volumes of sound. So after prolonged listening, what sounds 'normal' can actually be loud and harmful to your hearing. To guard against this, set your volume to a safe level before your hearing adapts and leave it there.

To establish a safe volume level:

Set your volume control at a low setting.

Slowly increase the sound until you can hear it comfortably and clearly, without distortion.

Listen for reasonable periods of time:

Prolonged exposure to sound, even at normally 'safe' levels, can also cause hearing loss.

Be sure to use your equipment reasonably and take appropriate breaks.

Be sure to observe the following guidelines when using your headphones.

Listen at reasonable volumes for reasonable periods of time.

Be careful not to adjust the volume as your hearing adapts.

Do not turn up the volume so high that you can't hear what's around you.

You should use caution or temporarily discontinue use in potentially hazardous situations.

Do not use headphones while operating a motorized vehicle, cycling, skateboarding, etc.; it may create a traffic hazard and is illegal in many areas.

Modifications

Modifications not authorized by the manufacturer may void user's authority to operate the product.

Copyright information

All other brands and product names are trademarks of their respective companies or organizations.

Unauthorized duplication of any recordings whether downloaded from the Internet or made from audio CDs is a violation of copyright laws and international treaties.

The making of unauthorized copies of copy-protected material, including computer programs, files, broadcasts and sound recordings, may be an infringement of copyrights and constitute a criminal offense. This equipment should not be used for such purposes.

The Windows Media and the Windows logo are registered trademarks of Microsoft Corporation in the United States and/or other countries.

Be responsible! Respect copyrights.



Be responsible
Respect copyrights

Philips respects the intellectual property of others, and we ask our users to do the same. Multimedia content on the internet may have been created and/or distributed without the original copyright owner's authorization. Copying or distributing unauthorized content may violate copyright laws in various countries including yours.

Compliance with copyright laws remains your responsibility.

The recording and transfer to the portable player of video streams downloaded to your computer is intended only for use with public domain or properly licensed content. You may only use such content for your private, non-commercial use and shall respect eventual copyright instructions provided by the copyright owner of the work. Such instruction may state that no further copies shall be made.

Video streams may include copy protection technology that prohibits further copying. For such situations the recording function will not work and you will be notified with a message.

Data logging

Philips is committed to improving the quality of your product and enhancing the Philips user experience. To understand the usage profile of this device, this device logs some info / data to the non-volatile memory region of the device. These data are used to identify and detect any failures or problems you as a user may experience while using the device. The data stored, for example, will be the duration of playback in music mode, duration of playback in tuner mode, how many times battery low was encountered, etc. The data stored do not reveal the content or media used on the device or the source of downloads. The data stored on the device are retrieved and used ONLY if the user returns the device to the Philips service center and ONLY to simplify error detection and prevention. The data stored shall be made available to user on user's first request.

Recycling the product

Your product is designed and manufactured with high quality materials and components, which can be recycled and reused. When you see the crossed-out wheel bin symbol attached to a product, it means the product is covered by the European Directive 2002/96/EC:



Never dispose of your product with other household waste. Please inform yourself about

the local rules on the separate collection of electrical and electronic products. The correct disposal of your old product helps prevent potentially negative consequences on the environment and human health.

Caution

- Removal of the built-in battery invalidate the warranty and may destroy the product. The following instructions are disposal instructions at the end of the product's life.

Your product contains a built-in rechargeable battery covered by the European Directive 2006/66/EC, which cannot be disposed of with normal household waste. To safeguard the functionality and safety of your product, take your product to an official collection point or service centre where a professional can remove or replace the battery as shown:

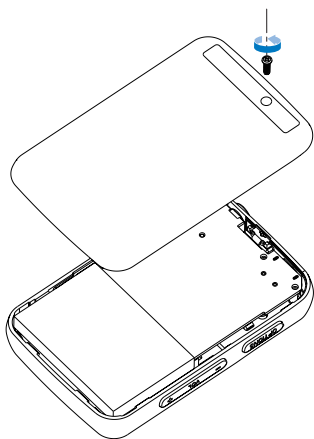

Please inform yourself about the local rules on separate collection of batteries. The correct disposal of batteries helps prevent potentially negative consequences on the environment and human health.

Notice for the European Union

This product complies with the radio interference requirements of the European Union.

2 Your new GoGear Vibe

GoGear Vibe allows you to

- play MP3 and WMA files
- view video files
- listen to FM radio
- make recordings

Quick start guide



Note

- The images serve as reference only. Philips reserves the right to change color/design without notice.

What's in the box

Check that you have received the following items:

Player



Earphones

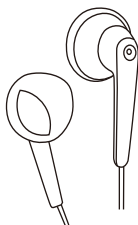

USB cable



3 Getting started

Overview of the controls and connections

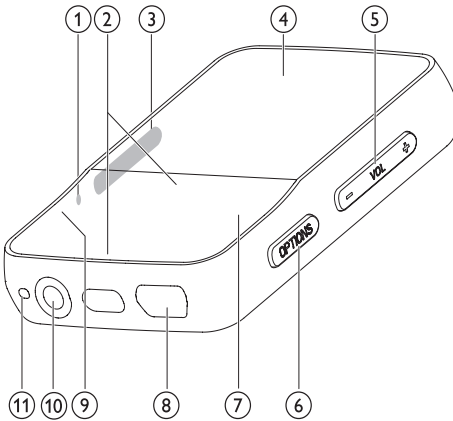

- ① **RESET** press: reset GoGear Vibe
- ② ▲ / ▼ press: scroll up/down
press and hold: scroll up/down at high speed
- ③ ⓘ slide and hold: turn GoGear Vibe on/off
🔒 slide: lock/unlock all buttons except **- VOL +**
- ④ display
- ⑤ **- VOL +** press: increase/decrease the volume
press and hold: increase/decrease fast
- ⑥ **OPTIONS** view available options
- ⑦ ▶|| press: play/pause
- ⑧ 📶 USB connection jack
- ⑨ ⏪ press: back one level
press and hold: scroll back at high speed
- ⑩ 🎧 headphone jack
- ⑪ **MIC** microphone

! **Caution**

- Listening to loud sounds for longer than a moment can be harmful to the listener.

You can set the volume level of GoGear Vibe to limit the maximum volume output.

- 1 From the main menu, select **[Settings]** > **[Sound settings]** > **[Volume limit]**.
- 2 Press the **- / +** volume controls to adjust the level.
- 3 Press **▶||** to confirm.
 - ↳ When you set a volume limit, GoGear Vibe can no longer exceed the set volume, even if you press the volume **+** button.

To enable maximum volume again:

- 1 Select **[Settings]** > **[Sound settings]** > **[Volume limit]**.
- 2 Set the volume limit to maximum.
- 3 Press **▶||** to confirm.

Overview of the main menu

Menu	Mode	To
🎵	Music	play music tracks
📺	Video	play videos
🖼️	Pictures	view pictures
📻	FM radio	listen to FM radio
🎙️	Recording	create or listen to recordings
📁	Folder view	view files in folders
⚙️	Settings	customize the settings of GoGear Vibe
🎧	Now playing	show the current play screen

☰ **Note**

- Rhapsody channels are available to some US versions only and require an active Rhapsody account.

Install software

GoGearVibe comes with the following software:

- Philips Device Manager (helps you get firmware updates for GoGear Vibe)
- Media Converter for Philips (helps you convert and transfer video files for GoGear Vibe)
- Windows Media Player (helps you convert and transfer WMP media files for GoGear Vibe)

Important:

Remember to install the software provided in the supplied CD-ROM for music and/or video transfer.

Important: Before installing the software, check that your computer meets the requirements (see section **System requirements** in this user manual).

- 1 Connect GoGear Vibe to your computer.
- 2 Insert the CD that comes with GoGear Vibe into the CD-ROM drive of your computer.
- 3 Follow the on-screen instructions to complete the installation of the software.

If the installation program fails to start automatically:

- 1 Browse the CD contents with Windows Explorer.
- 2 Double click on the file that ends with '.exe'.

Connect and charge

GoGearVibe has a built-in battery that can be charged through the USB port of a computer (USB cable included).

 **Note**





- For first-time use, allow GoGear Vibe to charge for 3 hours.
- The charging animation stops and the  icon is displayed when the charging process is completed.

Connect GoGearVibe to a computer

- 1 Connect the USB plug of the supplied USB cable to a spare USB port on your computer.
- 2 Connect the small USB plug of the USB cable to the small USB jack on GoGear Vibe.
- 3 Turn on your computer.
↳ GoGearVibe charges.

Battery level indication

The display indicates the approximate levels of the battery status as follows:

				
100%	75%	50%	25%	0%

- ↳ A flashing battery screen indicates that the battery is low. The player saves all settings and switches off within 60 seconds.

Note

- Rechargeable batteries have a limited number of charge cycles. Battery life and number of charge cycles vary by use and settings.
- The charging animation stops and the  icon is displayed when the charging process is completed.

Tip

- You can conserve battery power and increase the play time of the GoGear Vibe if you go to *** > [Display settings] > [Screen off timer]** and ensure that the shortest timer setting is selected.

Disconnect GoGear Vibe safely

To avoid data loss, disconnect GoGear Vibe from your computer as follows:

- 1 On your computer, exit all applications that are working with GoGear Vibe.
- 2 Click  in the task tray of your computer.
- 3 Wait for the confirmation that GoGear Vibe can be safely removed, then disconnect GoGear Vibe from the USB port.

Turn GoGear Vibe on and off

- 1 To toggle between modes on and off, slide and hold  for approximately 2 seconds.

Automatic standby and shut-down

GoGear Vibe has an automatic standby and shut-down feature that can save battery power.

After 10 minutes in idle mode (no music plays, no button is pressed), GoGear Vibe turns off.

- 1 Slide and hold  for approximately 2 seconds to turn GoGear Vibe on again.

GoGear Vibe has a lock switch to prevent accidental operation.

- 1 To lock the buttons when you play, move the slider to position .
 - ↳ All buttons except the volume keys are locked and the display shows a lock icon.
- 2 To unlock the buttons again, move the slider to the center position.

4 Use GoGear Vibe to carry files

GoGearVibe allows you to carry files in **Windows Explorer**.

- 1** With GoGear Vibe connected to the USB port of the computer, open **Windows Explorer**.
- 2** Create folders in GoGear Vibe.
- 3** Use drag and drop actions to sort your files into the folders.

5 Windows Media Player 11 (WMP11)

Install Windows Media Player 11 (WMP11)

- 1 Insert the supplied CD into the CD-ROM drive of your computer.
- 2 Follow the on-screen instructions to complete the installation of **WMP11**.

Transfer music and picture files to WMP11 library

By default, **WMP11** automatically loads all the music and picture files that are stored in your computer. The new files are also automatically added to the **WMP11** library. The following steps show how you can add music and picture files that are stored elsewhere on your computer or computer network:

- 1 Select **Start > All Programs > Windows Media Player** to launch the **WMP11** program.
- 2 Click the down arrow beneath the **Library** tab, then select **Add to Library...**



↳ Add to Library dialog box appears.

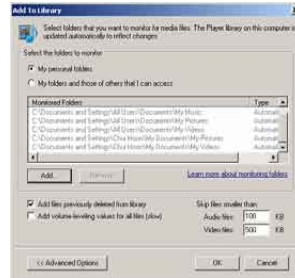

- 3 Click **<< Advanced Options** to expand the dialog box.
- 4 Click **Add...**
↳ Add folder dialog box appears.
- 5 Select a folder that contains your music or picture files, then click **OK**.
- 6 **WMP11** starts scanning the folder and adds available music or picture files to the library.
- 7 Click **Close** when done.

Tip

- **WMP11** is configured to skip audio files that are smaller than 100 KB. To include files smaller than 100 KB, you can change the default settings within the Add to library dialog box.

Switch between music and pictures library in WMP and GoGear Vibe

- 1 Click the arrow on the top left of WMP11, then select the category.



Rip songs from a CD

You can transfer music from a CD to GoGear Vibe. The transfer requires that you create a digital copy of the music on your computer first. This is called ripping.

- 1 Ensure that the computer is connected to the Internet.
- 2 Start WMP11.
- 3 Click the down arrow beneath the Rip tab and select the **Format**.



- 4 Click on the down arrow beneath the Rip tab and select the **Bit Rate**.



- 5 Insert the audio CD into the CD drive of the computer.



- ↳ All the tracks from the CD are listed. By default, WMP11 starts to rip all the songs from the CD.
- ↳ To modify this option, click the down arrow beneath the Rip tab and select **Rip CD Automatically When Inserted > Never**.

- 6 Click on the check boxes to select the songs that you want to rip.



- 7 Click **Start Rip**.
 ↳ The selected tracks are converted and added to the **WMP11** library.

Buy music online

You can select a music store and buy music online.

- 1 Start **WMP11**.
- 2 Click the down arrow beneath the **Media Guide** tab and select **Browse all Online Stores**.
- 3 Choose a store and follow the on-screen instructions.



- ↳ You can find the albums or songs you purchase in the **WMP11** library.

Sync your Windows Media content to GoGear Vibe

You can sync your music and pictures to GoGear Vibe using **WMP11**. When you connect GoGear Vibe to the computer for the first time, **WMP11** automatically selects the sync method (automatic or manual) that works best for GoGear Vibe.

Automatic: If GoGear Vibe has sufficient storage space (at least 4GB of free space) and your entire media library can fit on GoGear Vibe, your entire media library is automatically copied to GoGear Vibe when connected to the computer.

Manual: If your entire media library cannot fit on GoGear Vibe, you are prompted to manually select files or playlists for transfer to GoGear Vibe.

Set up GoGear Vibe for WMP11

! Caution

- Do not disconnect GoGear Vibe while transfer is in progress. If you disconnect GoGear Vibe, the transfer is incomplete and Windows may not be able to recognize GoGear Vibe afterwards.

- 1 Start **WMP11**.
- 2 Turn on GoGear Vibe.
- 3 Connect GoGear Vibe to the computer.
- 4 Set up sync:
 - If you are prompted: select the option to sync GoGear Vibe using **WMP11**.
 - If **WMP11** selects to sync GoGear Vibe automatically: click **Finish**.
 - Your entire library syncs to GoGear Vibe. Thereafter, GoGear Vibe syncs automatically when connected to the computer.
 - You can also choose what syncs automatically (see section **Select and prioritize what syncs automatically**).

- If **WMP11** selects to sync GoGear Vibe manually, click **Finish**.
- You are required to click the **Sync** tab and manually select the files and playlists for sync (see section **Select files and playlists for manual sync**).

Switch between automatic and manual sync

After the first sync setup, you can switch between automatic and manual sync:

- 1 Click the down arrow beneath the **Sync** tab, then select **PhilipsGoGear Vibe > Set Up Sync**.
- 2 Select or deselect the **Sync this device automatically** check box.

Select and prioritize what syncs automatically

If **WMP11** selects to sync GoGear Vibe automatically, you can choose not to sync your entire media library. You can choose what to sync from existing playlists or create new playlists. The playlists you select sync to GoGear Vibe every time you connect GoGear Vibe to the computer.

- 1 Click the down arrow beneath the **Sync** tab and select **Philips GoGear Vibe > Set Up Sync**.
↳ The Device Setup dialog box appears.



- 2 In the Available playlists pane, select the existing playlists you want to sync, then click **Add**.

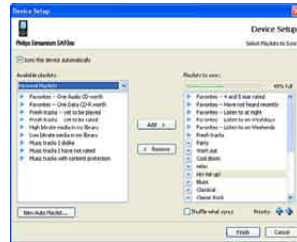

- 3 To create a playlist, click **New Auto Playlist**, then follow the steps on the screen to specify criteria. (See also section **Create an Auto Playlist**).
- 4 To remove a playlist, click the playlist in the list of **Playlists to sync**, then click **Remove**.
- 5 In the **Playlist to sync** pane, select the **Priority** arrows to arrange them in the order that you want them to sync.



- ↳ If GoGear Vibe is full before sync is complete, the files and playlists that are lower in priority on the list are omitted from sync.



Tip

- If your media library is too large to fit on GoGear Vibe, you can select the **Shuffle what syncs** check box, to shuffle the files that are in the playlists to sync. Thereafter, the files on GoGear Vibe are replaced with a new set of files (from the Playlists to sync pane) whenever GoGear Vibe is connected to the computer.

Select files and playlists for manual sync

If you want to sync manually, you are required to a list of files and playlists you want to sync. You can also shuffle which files from your playlists to sync to GoGear Vibe.

- 1 Start **WMP11**.
- 2 Turn on GoGear Vibe.
- 3 Connect GoGear Vibe to the computer.
- 4 Click the **Sync** tab.
- 5 Drag the files and playlists that you want to sync from the Contents pane to the **Sync List** pane.
 - You can also click on the file or playlist and select **Add to 'Sync List'**.



- 6 In the Sync List pane, verify that the items you have selected to sync can all fit on GoGear Vibe.
 - If necessary, remove items from the list.



- 7 To remove items, right click on the item in the Sync List pane, then select **Remove from List**.
- 8 Click **Start Sync** button to transfer the Sync List items to GoGear Vibe.

- ↳ The progress is displayed on the bottom right of **WMP11**.
- ↳ Click **Stop Sync** to stop the transfer.



Tip

- If the tracks to sync are protected, you are prompted to upgrade the security components on your computer. When this happens, you can play the track in **WMP11** and when prompted, follow the steps on the screen to upgrade the security components. After you have upgraded your security components, you can sync the file to GoGear Vibe.

Copy files from GoGear Vibe to your computer

GoGear Vibe supports reverse sync, which lets you copy files from GoGear Vibe to your computer with **WMP11**.

- 1 Start **WMP11**.
- 2 Turn on GoGear Vibe.
- 3 Connect GoGear Vibe to the computer.
- 4 Click on **Philips GoGear Vibe** in the left Navigation pane.
 - ↳ The content on GoGear Vibe is listed in the Contents pane.
- 5 Navigate to the file or playlist you want to copy from GoGear Vibe to the computer.
- 6 Right click on the file or playlist, then select **Copy from Device**.

WMP11 playlists

Playlists allow you to mix any combination of songs or pictures you want. You can create regular or auto playlists in **WMP11**. These playlists can contain songs, pictures, or both.

Create a regular playlist

- 1 Click the down arrow beneath the **Library** tab and select **Create Playlist**.
↳ Untitled Playlist appears on the List pane.
- 2 Click on **Untitled Playlist** and enter a new name for the playlist.
- 3 To add items to your playlist, drag them from the Contents pane to the List pane. (Your playlist can contain both songs and pictures.)



- 4 When you have finished adding items to the playlist, click **Save Playlist**.

Create an auto playlist

WMP11 can automatically generate playlists based on various criteria.

- 1 Click the down arrow beneath the **Library** tab, then select **Create Auto Playlist**.
↳ A New Auto Playlist dialog box appears.
- 2 Enter a name for the auto playlist.



- 3 Click the first green plus sign and select your first criteria from the pull-down list.
- 4 Click on the underlined words to refine your criteria.
- 5 Click the second and third green plus signs to select and define more criteria for your auto playlist.
- 6 Click **OK** button when done.

Edit playlist

You can edit your existing playlists at any time.

- 1 In the left Navigation pane, click on **Playlists**.



- ↳ All your playlists are displayed in the Contents pane.
- Right click on the playlist you want to edit, then select **Edit in List Pane** from the pop-up menu.

- ↳ The content in the playlist appears in the List pane.

To remove an item from the playlist, right click on the item, then select **Remove from List**.



To change the order of the items in the playlist, click and drag any item to a new position within the List pane.

To add a new item to the playlist, select it from the library and drag it to the List pane.

When you have finished editing the playlist, click the **Save Playlist** button.

Transfer playlists to GoGear Vibe

The section **Select files and playlists for manual sync** in this user manual shows how to transfer of playlists to GoGear Vibe.

Search for music or pictures with WMP11

- 1 Click the **Library** tab.
- 2 Click the arrow on the top left of **WMP11**, then select **Music** or **Pictures** to search.
- 3 Type a few keywords of the file, such as song title or artist in the search box.
 - ↳ The search results appear in the Contents pane as you type. Results are updated as you enter each new letter

- 4 To refine your search results, enter more keywords.

Delete files and playlists from WMP11 library

- 1 Click the **Library** tab.
- 2 Click the arrow on the top left of WMP11, then select **Music** or **Pictures** for deletion.
- 3 Navigate to the file or playlist you want to delete.
- 4 Right click on the file or playlist, then select **Delete**.
- 5 Select **Delete from library only** or **Delete from library and my computer**, then click **OK**.

Delete files and playlists from GoGear Vibe

You can use **WMP11** to manage the files stored on GoGear Vibe. When you connect GoGear Vibe to the computer, the contents on GoGear Vibe is displayed in **WMP11**. You can delete files or playlists, just like any other files displayed in **WMP11**.

- 1 In the left Navigation pane, click on **Philips GoGear Vibe**.
- 2 You can browse the contents of GoGear Vibe in a variety of views, such as Recently Added or Artists.
- 3 The contents on GoGear Vibe is listed in the Contents pane.
- 4 To delete music or picture files, click the arrow on the top left of **WMP11**, then select **Music** or **Pictures**.
- 5 Navigate to the file or playlist you want to delete.
- 6 Right click on the file or playlist, then select **Delete**.

7 Click **OK**.



4 Select the appropriate tab, then enter or edit the information.



5 Click **OK** to save your changes.

Edit song information with WMP11

- 1 Click the **Library** tab.
- 2 Navigate to the song you want to edit.
- 3 Right click on the song, then select **Advanced Tag Editor** from the pop-up menu.
↳ The advanced Tag Editor dialog box appears.



Format GoGear Vibe with WMP11



! Caution

- This procedure reformats the storage on GoGear Vibe and erases all data.

- 1 Start **WMP11**.
- 2 Turn on **GoGear Vibe**.
- 3 Connect **GoGear Vibe** to the computer.
- 4 Click the down arrow beneath the **Sync** tab, then select **Philips GoGear Vibe > Format**.

6 Music

Listen to music

- 1 From the main menu, select  to enter music mode.
- 2 Navigate the sub-menus to select your music.
- 3 Press  to play.
 - Press  to toggle between pause and play.

Find your music

From the main menu, select  to enter music mode.

GoGearVibe offers the following menu options:

[All songs]

- Alphabetically listed tracks

[Artists]

- Alphabetically listed artists
- Alphabetically listed albums
- Tracks listed in album order

[Albums]

- Alphanumerically listed albums
- Tracks listed in album order



[Playlists]

- **[Playlist-on-the-go]**
- Tracks listed in playlist order

Note

- Alternatively, you can select  from the main menu and find your files in folder view.

Delete music tracks

- 1 From the main menu, select .
- 2 Press  /  to locate a track.
- 3 Press **OPTIONS** to view options menu.
- 4 Select the delete option to delete the track.

7 Audiobooks

GoGear Vibe supports books in audio format. The use of this feature requires that you download the **AudibleManager** from audible.com. With the **AudibleManager** you can manage the digital contents of your audiobooks. Visit audible.com and register. The onscreen instructions guide you through the **AudibleManager** software download process. While you listen to an audiobook, you can navigate the same way as you would in any other audio file.

Add audiobooks to GoGear Vibe

- **Important:** GoGear Vibe supports audiobook format 4.
- 1 On your computer, launch **AudibleManager**.
 - 2 Follow the online instructions to download your audiobooks in format 4.
 - 3 Follow the **AudibleManager** on-screen instructions to activate GoGear Vibe for your audiobooks.
 - 4 Follow the **AudibleManager** on-screen instructions to transfer your audiobooks to GoGear Vibe.

Note

- GoGear Vibe can only play audiobooks in format 4.
- GoGear Vibe can only play audiobooks for which it is **activated**.

Audiobook controls

GoGear Vibe offers the following audiobook mode controls:

Goal	Action
Play / pause	Press ▶
Skip forward to beginning of new section / chapter	Press ▶
Skip back to beginning of current section / chapter	Press ◀
Fast skip forwards through audiobook	Press and hold ▶
Fast skip backwards through audiobook	Press and hold ◀
Return to browsing menu	Press ↶
Increase / decrease volume	Press - VOL +

Tip

- You can resume play after navigating away from audiobooks (see section **Resume play** in this user manual).

Select audiobook by book title

- 1 From the main menu, select **🎵** to enter music mode.
- 2 Press **▲** or **▼**, then **▶||** to select **Audiobooks**.
- 3 Press **▲** or **▼** to select title, then **▶||** to play.
↳ To exit, press **↶**.

8 Video

Download, convert and transfer videos

MediaConverter™ for Philips enables you to

- download videos from the Internet to your PC at the click of a button.
- convert video files on your PC to the correct screen size of GoGear Vibe.
- transfer converted videos from your PC to GoGear Vibe.



Note

- Video conversion and transfer can take a long time, depending on your PC configuration.

Delete videos

- 1 From the main menu, select to enter video mode.
- 2 Press / to locate a video.
- 3 Press to play.
- 4 Press **OPTIONS** to view options menu.
- 5 Select the delete option to delete the video.



Note

- Alternatively, you can select from the main menu and find your files in folder view.



Play videos

- 1 From the main menu, select to enter video mode.
- 2 Navigate the sub-menus to select your video.
- 3 Press to play.
 - Press to toggle between pause and play.
- 4 During video play, press and hold / to scan fast forward / backward.
 - Press to resume play.

9 Pictures

View pictures

GoGear Vibe supports a range of picture formats (see section **Supported formats** in this user manual).

- 1 From the main menu, select  to enter picture mode.
- 2 Press  /  to move to next / previous picture.

View slideshow

While in  mode, you can view your pictures as a slideshow:

- 1 Press  to start the slideshow.





Tip

- The menu **Settings** offers various slideshow settings.

Add pictures to GoGear Vibe

- 1 With GoGear Vibe connected to the USB port of the computer, open **Windows® Explorer**.
- 2 Create folders in GoGear Vibe.
- 3 Use drag and drop actions to sort your pictures into the folders.

Delete pictures

- 1 From the main menu, select  to enter picture mode.
- 2 Press  /  to locate a picture.
- 3 Press **OPTIONS** to view options menu.
- 4 Select the delete option to delete the picture.



Note

- Alternatively, you can select  from the main menu and find your files in folder view.





10 Radio

Listen to FM radio

- 1 From the main menu, select  to enter radio mode.
 - The earphones cable acts as FM antenna.



Manually tune a radio station

While in  mode, you can manually tune to a radio station:







- 1 To search for the next stronger signal, press and hold  / .
- 2 To fine tune the frequency, briefly press  / .

Auto-tune preset radio station

The auto-tune feature of GoGear Vibe helps you find radio stations and save them under the preset numbers.

- 1 While in  mode, select **[Auto tune]** > **[Yes]**.
 - ↳ The radio automatically tunes radio stations and saves the frequencies to presets.
 - ↳ There are 20 presets available.
 - ↳ To stop auto tuning, press .
 - ↳ To exit radio, press and hold  for 2 seconds.

Play a preset radio station

- 1 In  mode, you can play previously set radio stations (presets):
- 2 Press **OPTIONS** to view options menu.
- 3 Select preset.
- 4 Press  /  to change to another preset.
- 5 To search for the next stronger signal, press and hold  /  for 2 seconds.
 - To exit radio, press and hold  for 2 seconds.







Note

- You can play presets only after you have stored radio stations under presets. (See **Auto-tune preset radio stations** or **Manually tune a radio station** in this user manual.)

11 Recordings

Record from FM radio

- 1 From the main menu, select  to enter radio mode.
- 2 Select radio station (preset).
- 3 Press **OPTIONS** to view options menu.
- 4 Select **[Start FM radio recording]**.
 - Press  to toggle between pause and record.
- 5 Press  to stop.
 - ↳ The screen prompts you to save the recording.
- 6 Press  to select **[Yes]** / **[No]**.
- 7 Press  to confirm.
 - ↳ Recordings are saved on the player. (Filename format: FMRECXXX.MP3, where XXX is the recording number that is generated automatically.)







Tip

- You can find your recordings under **[Recordings library] > [FM radio]**.

Record audio/voices

This is how you can record audio/voices with the built-in microphone (see section **Overview** for location of built-in microphone):



- 1 From the main menu, select  to enter recordings mode.
- 2 Select **[Start voice recording]**.
 - Press  to toggle between pause and record.
- 3 Press  to stop.
 - ↳ The screen prompts you to save the recording.
- 4 Press  to select **[Yes]** / **[No]**.
- 5 Press  to save the recording.
 - ↳ Recordings are saved on the player. (Filename format: VOICEXXX.MP3, where XXX is the recording number that is generated automatically.)





Tip

- You can find your recordings under **[Recordings library] > [Voice]**.

Listen to FM recordings

- 1 From the main menu, select  to enter recordings mode.
- 2 Select **[Recordings library] > [FM radio]**.
- 3 Select a recording.
- 4 Press  to play.

Listen to voice/audio recordings

- 1 From the  menu select **[Recordings library] > [Voice]**.
- 2 Select a recording.
- 3 Press  to play your recording.

Upload your recordings to a computer

- 1 Connect GoGear Vibe to the computer (see section **Connect and charge** in this user manual).
- 2 On the computer, in **Windows® Explorer** select GoGear Vibe.
- 3 Select **Recordings > Voice** or **FM radio**.
- 4 Copy and paste the recordings to any location on the computer.

Delete recordings

Use a computer to delete recordings from GoGear Vibe:

- 1 Connect GoGear Vibe to the computer (for instructions see section **Connect**).
- 2 On the computer, in **Windows® Explorer** select GoGear Vibe.
- 3 Select **Recordings > Voice** or **FM radio**.
- 4 Select the recordings you want to delete.
- 5 On the computer, press **Delete**.
↳ The selected recordings are deleted.

12 Settings

This is how you customize GoGearVibe:

From the main menu, select ***** to enter settings mode.

In the ***** menu, navigate as follows:

- 1 Press **▲** / **▼** to select an option.
- 2 Press **▶||** to confirm a selection and go to the next level (when available).
- 3 Press **↶** to return to the previous level.
- 4 Press and hold **↶** to exit the ***** menu.

In the ***** menu, the following options are available:

Settings	Options menu	Sub-options menu
[Play mode]	[Repeat]	<ul style="list-style-type: none">• [Repeat off] (default)• [Repeat 1]• [Repeat all]
	[Shuffle]	<ul style="list-style-type: none">• [Shuffle off] (default)• [Shuffle all]
[Sound settings]	[Equalizer]	<ul style="list-style-type: none">• [Off] (default)• [Rock]• [Funk]• [Hip hop]• [Jazz]• [Classical]• [Techno]• [Custom]
	[Volume limit]	Vertical bar indicator. Press - VOL + to adjust volume limit, then press ▶ to confirm.
[Sleep timer]	<ul style="list-style-type: none">• [Off] (default)• xx [mins]	
[Display settings]	[Brightness]	Vertical bar indicator. Press ▲ or ▼ to adjust brightness, then press ▶ to confirm
	[Theme]	<ul style="list-style-type: none">• [Dark] (default)• [Red]• [Light]
	[Backlight timer]	<ul style="list-style-type: none">• [[x] seconds]
	[Screen off timer]	<ul style="list-style-type: none">• [[x] seconds]• [Always on]

[Display settings]	[Screensaver]	<ul style="list-style-type: none"> • [Off] (default) • [Song title] • [Album art] • [Analog clock] • [Digital clock] • [Demo mode] 	
[Date and time]	[Time settings]	<ul style="list-style-type: none"> • [Set time format] • Set time 	
	[Date settings]	<ul style="list-style-type: none"> • [Set date format] • Set date 	
[Slideshow settings]	[Time per slide]	<ul style="list-style-type: none"> • [[x] seconds] 	
	[Repeat]	<ul style="list-style-type: none"> • [Off] (default) • [On] 	
	[Shuffle]	<ul style="list-style-type: none"> • [Off] (default) • [On] 	
[Language]	<ul style="list-style-type: none"> • [English] (default) • Czech • Greek • German • Spanish • French • Italian • Hungarian 	<ul style="list-style-type: none"> • Dutch • Norwegian • Polish • Portuguese • Portuguese (Brazilian) • Russian • Slovak • Finnish 	<ul style="list-style-type: none"> • Swedish • Turkish • Simplified Chinese • Traditional Chinese • Japanese • Korean • Thai (197 version only)
[Connect PC preference]	<ul style="list-style-type: none"> • [MSC] • [MTP] (default) 		
[Information]	<ul style="list-style-type: none"> • [Capacity:] • [Free space:] • [Firmware version:] • [Model:] • [Support site:] 		
[Factory settings]	[Restore factory settings? (Files transferred to player will not be affected.)]	<ul style="list-style-type: none"> • [Yes] • [No] 	

13 Update GoGear Vibe

GoGear Vibe is controlled by an internal program called firmware. Newer versions of the firmware may have been released after you have purchased GoGear Vibe.

The software program called **Philips Device Manager** can use your computer to check for firmware updates that are available on the Internet.

Install **Philips Device Manager** on your computer from GoGear Vibe or download the latest version from www.philips.com/support.

Note

- Your music files are not affected by a firmware update.

- 6 Disconnect GoGear Vibe from the computer.
 - ↳ GoGear Vibe restarts after the firmware is updated and is ready for use again.

Manually verify / update firmware

- 1 Ensure that your computer is connected to the Internet.
- 2 Connect GoGear Vibe to the computer (see section **Connect and charge** for instructions).
- 3 On your computer, click **Start > Programs > Philips Digital Audio Player > Vibe Device Manager** to launch **Philips Device Manager**.
- 4 Click **Update**
 - ↳ **Philips GoGear Vibe Device Manager** checks for updates and installs new firmware from the Internet, if available.
- 5 When the display shows **Update completed**, click **OK**.

14 Troubleshooting

If GoGear Vibe is not working properly or the display freezes, you can reset it without losing data:

How do I reset GoGear Vibe?

- Insert a pen tip or other object into the reset hole located at the left hand side of GoGear Vibe. Hold until the player shuts down.
- If the reset option is unsuccessful, follow the steps how to recover GoGear Vibe with the **Philips Device Manager**:
 - 1 On your computer, select **Start > Programs > Philips Digital Audio Player > Vibe Device Manager > Philips Device Manager** to launch the **Philips Device Manager**.
 - 2 Turn off GoGear Vibe before you continue.
 - 3 Press and hold the volume button **+** while you connect GoGear Vibe to your computer.
 - 4 Keep holding the key until the **Philips Device Manager** acknowledges GoGear Vibe and enters the recovery mode.
 - 5 On the computer, click the **Repair** button and follow the instructions of the **Philips Device Manager** to complete the recovery process.
 - 6 When the recovery is completed, disconnect GoGear Vibe from your computer.
 - 7 Restart GoGear Vibe.

15 Technical data

Power

Power supply: 290 mAh Li-ion polymer internal rechargeable battery
Play time¹ (music): 25 hours

Software on CD-ROM

Philips Device Manager: to restore and upgrade

Media Converter for Philips: to convert and transfer media files

Windows Media Player

Connectivity

Headphone 3.5 mm
USB 2.0 High speed

Sound

Channel separation: 45 dB
Frequency Response: 80 Hz - 18 kHz
Output power: 2 x 3 mW
Signal to noise ratio: > 84 dB

Audio playback

Compression format:
MP3 bit rates: 8 - 320 kps and VBR
MP3 sample rates: 8, 11.025, 16, 22.050, 24, 32, 44.1, 48 kHz
WMA bit rates: 5 - 192 kbps VBR
WMA sample rates: 8, 11.025, 16, 22.050, 24, 32, 44.1, 48 kHz
ID3-tag support
Audible format support

Video playback

SMV format support

Storage media

Built-in memory capacity²:
SA1VBE02 2GB NAND Flash
SA1VBE04 4GB NAND Flash
SA1VBE08 8GB NAND Flash
SA1VBE16 16GB NAND Flash

Music transfer³

Drag and drop in Windows® Explorer

Display

Color LCD 128 x 128 pixels

Note

- ¹ Rechargeable batteries have a limited number of charge cycles. Battery life and number of charge cycles vary by use and settings.
- ² 1GB = 1 billion bytes; available storage capacity is less. Full memory capacity may not be available as some memory is reserved for the player. Storage capacity is based on 4 minutes per song and 128 kbps MP3 encoding.
- ³ Transfer speed depends on operating system and software configuration.

System requirements

- Windows® XP (SP2 or above) / Vista
- Pentium III 800 MHz processor or higher
- 520 MB RAM
- 500 MB hard disk space
- Internet connection
- Windows® Internet Explorer 6.0 or later
- USB port

Supported music file formats

GoGear Vibe supports the following music formats:

- MP3
- PCM
- ADPCM
- Audible
- WMA

Supported video file formats

GoGear Vibe supports the following video formats:

- SMV

Supported picture file formats

GoGear Vibe supports the following picture formats:

- JPEG

16 Glossary

A

Album art

Album art is a feature that displays the artwork (cover picture) of a music album. This display enables the user to quickly identify a music album. The artwork files for music albums can be downloaded from the Internet.

C

Compression

In audio terms, this is a process of temporarily or permanently reducing audio data for more efficient storage or transmission. A temporary reduction in file size is called 'non-lossy' compression, and no information is lost. A permanent reduction in file size (such as with MP3 files) is called 'lossy' compression, and involves discarding unnecessary information which is irretrievably lost.

D

Decibel (dB)

A unit of measure used to express relative difference in power or intensity of sound.

Digital Audio

Digital Audio is a sound signal that has been converted into numerical values. Digital sound can be transmitted through multiple channels. Analog sound can only be transmitted through two channels.

F

FM (Frequency Modulation)

In radio broadcasting: a method of modulation in which the frequency of the carrier voltage is varied with the frequency of the modulation voltage.

J

JPEG

A very common digital still picture format. A still-picture data compression system proposed by the Joint Photographic Expert Group, which features small decrease in image quality in spite of its high compression ratio. Files are recognized by their file extension '.jpg' or '.jpeg'.

K

Kbps

Kilobits per second. A digital-data-rate measurement system which is often used with highly compressed formats such as AAC, DAB, MP3 etc. The higher the amount, the better the quality generally is.

L

LCD (Liquid Crystal Display)

Probably the most common way to show visual information on non-computer electronic equipment.

M

MHz (Mega Hertz)

One million cycles per second.

MP3

A file format with a sound data compression system. MP3 is the abbreviation of Motion Picture Experts Group 1 (or MPEG-1) Audio Layer 3. With the MP3 format, one CD-R or CD-RW can contain about 10 times more data than a regular CD.

P

PCM (Pulse Code Modulation)

Pioneering form of digital recording.

PlaysForSure*

PlaysForSure* is a Philips GoGear feature that ensures compatibility with Windows Media Player 10 and Windows XP. The PlaysForSure* logo assures the consumer that the music purchased at an online shop with this logo is compatible with the Philips GoGear player.

S

Shuffle

A feature that plays audio files (tracks) in random order.

SMV [SigmaTel Motion Video Format]

A partially compressed video format by SigmaTel that allows conversion of common PC motion video files for play on a portable multimedia player.

Stereo

Literally means solid. Usually taken to refer to two channel stereo, though developments in digital audio facilitate multichannel stereo.

SuperPlay

SuperPlay™ is a special feature of the product, which enables the listener to play all the music under a top-level library category, such as artists or albums, without having to select playlist items.

SuperScroll

SuperScroll™ is a navigation feature of the double-action search keys of the product. SuperScroll™ allows easy speed control when scrolling through large libraries to swiftly find items within large libraries. Longer press of the button results in faster scroll speed.

T

Thumbnail

A thumbnail is reduced-size versions of a picture that is used to make it easier to recognize an them. Thumbnails serve the same role for images as a normal text index does for words.

V

Volume

Volume is the most common word used to specify the control of relative loudness of sounds. It also pertains to the function on many electronic devices that is used to control the loudness.

W

WAV

A format for sound files developed jointly by Microsoft and IBM. Built into Windows 95 to XP, which made it the de facto standard for sound on PCs. WAV sound files end with a '.wav' extension and works with nearly all Windows applications that support sound.

WMA (Windows Media Audio)

An audio format owned by Microsoft, is a part of Microsoft Windows Media technology. Includes Microsoft Digital Rights Management tools, Windows Media Video encoding technology, and Windows Media Audio encoding technology.

WMV [Windows Media Video]

Refers to a video compression technology developed by Microsoft Corporation. WMV content can be encoded by using Windows Media® Encoder 9 series. Files are recognised by their file extension '.wmv'.

