

# WYNDHAM COLLECTION

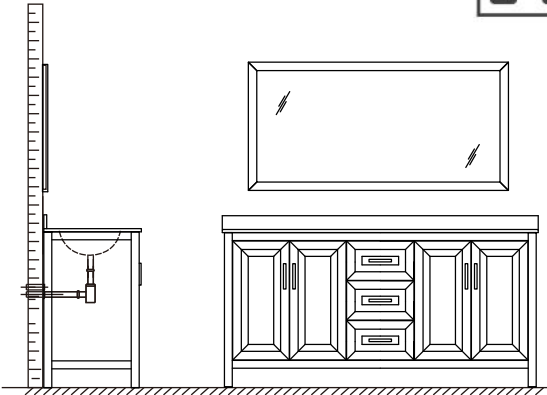

- Prior to installation please check received items against the "Packing List". Please report any missing items to your retailer immediately.
- Protect all surfaces from sharp objects, high heat sources, direct prolonged sunlight and chemical hazards.
- Professional installation recommended.
- Backsplash comes in two pieces.

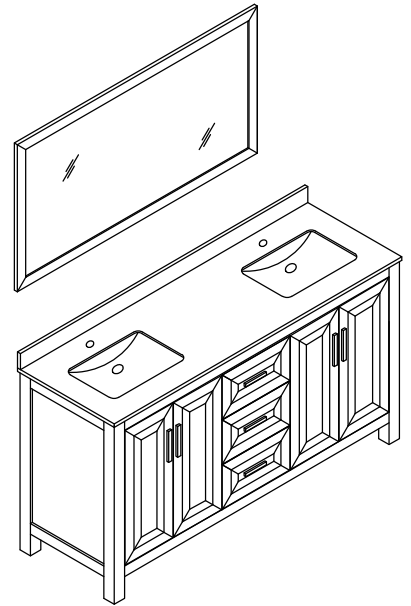

## PACKING LIST

(Not all components may be included, depending upon your purchase)

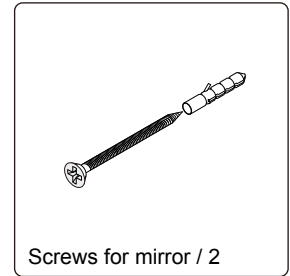
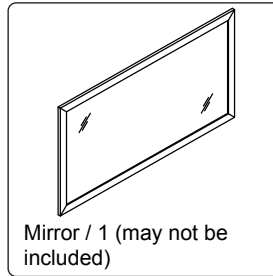
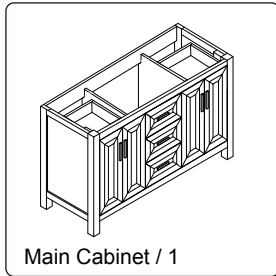
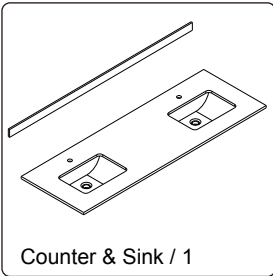

## HOW TO ADJUST HINGES (if required)

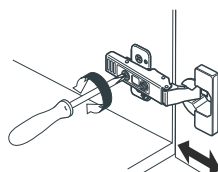
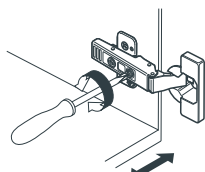
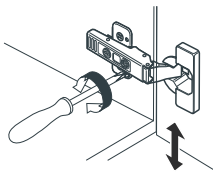

## REQUIRED TOOLS NOT IN BOX

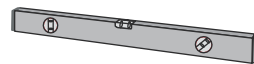
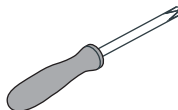
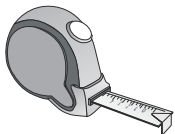

# WC-2525-80-DBL Installation Guide

# WYNDHAM COLLECTION

## INSTALLATION INSTRUCTIONS

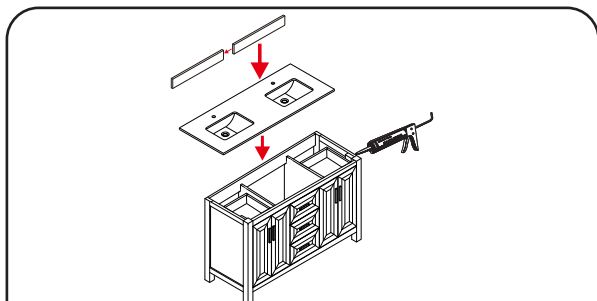

① Install the counter. Seal around the top of the cabinet with clear silicone sealant. Do not over apply. Allow to dry 24 hours for proper curing.

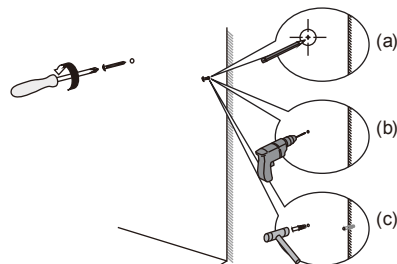

② Install the mirror: a) use a pencil to mark the placement of the screw holes on the wall, b) drill holes, c) insert the plastic wall anchors.

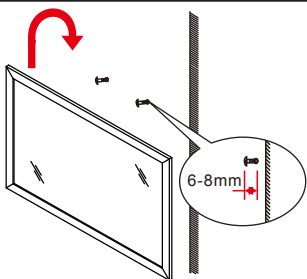

③ Install the screws into the wall anchors, leaving enough of the screw exposed to hang the mirror - approx 1/4" - 1/2".

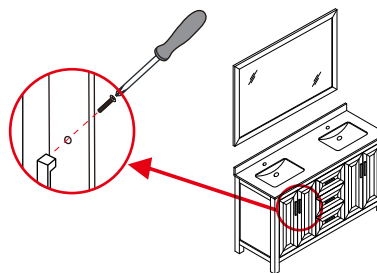

④ Remove the handles from inside the cabinet doors and drawers and reinstall on the outside. Do not over tighten when reattaching.

WC-2525-80-DBL  
Installation Guide